

SOLUTIONS AROUND THE GLOBE
 KYOCERA SGS Precision Tools is an ISO 9001:2015 Certified leader of round solid carbide cutting tool technology for the aerospace, metalworking, and automotive industries with manufacturing sites in the United States and United Kingdom. Our global network of Sales Representatives, Industrial Distributors, and Agents blanket the world selling into more than 60 countries.

LEADERS IN SOLID CARBIDE TOOL TECHNOLOGY

Brand names such as Z-Carb, S-Carb®, V-Carb, Hi-PerCarb®, Multi-Carb have become synonymous with high performance tooling in the machining and metalworking industry.

We're proud to have pioneered some of the world's most advanced cutting technology right here on our Northeast Ohio manufacturing campus. KSPT high performance end mills, drills and routers are increasing productivity and reducing cost around the world.

EXCEEDING CUSTOMER EXPECTATIONS

As the world's manufacturing needs change, so does KSPT. It's all about the science, starting with our lab inspected substrate materials to our tool designs and coatings. Our exceptional team of researchers, engineers, and machinists are dedicated to developing the absolute best and delivering the ultimate Value at the spindle®.

- Incredible batch-to-batch consistency
- Metallurgical lab dedicated to testing and rigorous quality control
- ISO 9001:2015 Certified quality procedures
- Patented geometries that extend tool life, reduce chatter, cut cycle times, and improve part quality—even at extreme parameters
- Specialists in extreme and demanding product applications
- Comprehensive tooling services
- Experienced Field Sales Engineers who work to optimize a tool for your particular application
- Dedicated multi-lingual customer service representatives

SGS PRODUCTS ARE DISTRIBUTED BY:



www.kyocera-sgstool.com



VALUE AT THE SPINDLE®

UNITED STATES OF AMERICA

KYOCERA SGS Precision Tools
 150 Marc Drive
 Cuyahoga Falls, Ohio 44223 U.S.A.
 customer service -
 US and Canada: (330) 686-5700
 fax - US & Canada: (800) 447-4017
 international fax: (330) 686-2146
 orders: sales@kyocera-sgstool.com
 web: www.kyocera-sgstool.com

UNITED KINGDOM

KYOCERA SGS Precision Tools Europe Ltd.
 10 Ashville Way
 Wokingham, Berkshire
 RG41 2PL England
 phone: (44) 1189-795-200
 fax: (44) 1189-795-295
 e-mail: SalesEU@kyocera-sgstool.com
 web: www.kyocera-sgstool.co.uk

JAPAN

KYOCERA Corporation
 International Sales Dept.
 6 Takeda Tobadono-cho,
 Fushimi-ku, Kyoto 612-8501, Japan
 phone: +81-75-604-3473
 fax: +81-75-604-3472
 web: global.kyocera.com/prdct/tool/index.html

COMMERCIAL OFFICES

EASTERN EUROPE

SINTCOM
 Sintcom Tools
 95 Arsenalski Blvd.
 1421 Sofia, Bulgaria
 phone: (359) 283-64421
 fax: (359) 286-52493
 e-mail: sintcom@sintcomtools.com

FRANCE

DOGA-KSPTE FRANCE
 8, Avenue Gutenberg
 78310 Maurepas, France
 phone: +33 (0) 1 30 66 41 64
 fax: +33 (0) 1 30 66 41 49
 e-mail: KSPTF@kyocera-sgstool.com
 web: www.doga.fr

GERMANY

KADIGO Tool Systems GmbH
 Walramster. 27
 65510 Idstein, Germany
 phone: +49-212-645573-0
 fax: +49-212-38089693
 e-mail: info@kadigo-ts.com

INDIA

KYOCERA Asia Pacific India Pvt. Ltd
 Plot No.51, Phase-I,
 Udyog Vihar Gurgaon 122016,
 Haryana, India
 phone: +91-124-4025022
 fax: +91-124-4025001

KOREA

KYOCERA Precision Tools Korea Co., Ltd.
 2LT 69BL, Namdong Industrial Estate,
 638-1, Kozan-Dong, Namdong Incheon,
 Korea
 phone: +82-32-821-8365
 fax: +82-32-821-8369
 web: www.kptk.co.kr/

POLAND

KYOCERA SGS Precision Tools
 phone: +48 530 432 002
 e-mail: SalesEU@kyocera-sgstool.com

RUSSIA

HALTEC
 phone: (7) 495-252-05-00
 e-mail: info@haltec.ru
 web: www.haltec.ru

SPAIN

KYOCERA SGS Precision Tools IBERICA
 e-mail: SalesEU@kyocera-sgstool.com

THAILAND

KYOCERA Asia Pacific (Thailand) Co., Ltd.
 1 Capital Work Place Building
 7th Floor, Soi Chamchan, Sukhumvit
 55 Road, Klongton Nua, Wattana,
 Bangkok 10110, Thailand
 phone: +66-2-030-6688
 fax: +66-2-030-6600

SINGAPORE

KYOCERA Asia Pacific Pte. Ltd.
 298 Tiong Bahru Road, #13-03/05 Central Plaza,
 Singapore 168730
 phone: +65-6373-6700
 fax: +65-6271-0600
 web: asia.kyocera.com/products/cuttingtools/
 index.html

CHINA

KYOCERA (China) Sales & Trading Corporation
 Room 140, Building A3, Daning Central Square,
 No. 700 Wanrong Road,
 Zhabei District, Shanghai, 200072,
 P.R. China
 phone: +86-21-3660-7711
 fax: +86-21-568-6200
 web: www.kyocera.com.cn/prdct/cuttingtool



EDP 00008 Rev 1220
 KYOCERA SGS Precision Tools



2021 Global Product Catalog



VALUE AT THE SPINDLE®

2021 Global Product Catalog



www.kyocera-sgstool.com

ISO 9001:2015 Certified



VALUE AT THE SPINDLE®

KYOCERA SGS Precision Tools (KSPT) is an ISO 9001:2015 Certified manufacturer of industry leading round solid carbide cutting tools. State of the art manufacturing and warehouse facilities have the capacity and processes to meet the quality and delivery demands of customers in all markets around the world. Complete inspections performed within its metallurgical lab and manufacturing quality departments ensure the use of high quality carbide and reliable manufacturing consistency regardless of when a cutting tool is produced.

KSPT is proud to have pioneered some of the world's most advanced cutting technologies due to rigorous testing of tools, coatings, and materials within its Global Innovation Center. It is this commitment to innovation that has launched patented products and technologies like the Z-Carb with its variable geometry and cutting edge preparation, Series 43 APR® and APF® ultra high performance aluminum cutting tools, and the JetStream coolant technology.

SGS has become an important part of the KYOCERA Precision Tools family, and while the name has changed, one thing has not. Its dedicated people and their relentless commitment to the customer. KSPT Technical Sales Engineers, Application Specialists, and Distribution Partners blanket the globe, delivering reliable service and support to all market segments. It is these people and products that drive innovative application strategies and cutting tool technologies into the end user, continually exceeding expectations and providing the most Value at the Spindle®.



Hardness Conversion Chart

ROCKWELL HARDNESS (HRb)	ROCKWELL HARDNESS (HRc)	BRINELL HARDNESS (HB)	VICKERS HARDNESS (HV)	TENSILE STRENGTH (N/mm2)	PSI (1000lb/in2)
67	—	121	122	401	58
70	—	126	127	432	63
73	—	132	132	448	65
75	—	136	137	455	66
77	—	140	143	463	67
80	—	147	150	479	69
82	—	153	156	494	72
84	—	159	163	525	76
86	—	165	171	540	78
89	—	177	178	556	81
91	—	186	188	602	88
93	—	197	196	632	92
96	—	216	212	664	97
97	—	223	218	695	101
98	21	230	234	756	110
—	22	236	241	772	112
—	23	242	247	787	114
—	24	248	255	818	118
—	25	254	261	849	123
—	27	266	269	865	125
—	28	272	275	895	130
—	29	278	284	911	132
—	30	284	292	942	136
—	31	293	300	973	141
—	32	302	308	988	143
—	33	310	318	1019	147
—	34	319	327	1050	152
—	35	328	337	1096	159
—	37	345	349	1127	163
—	38	353	359	1158	168
—	39	362	370	1189	172
—	40	370	381	1235	179
—	41	381	395	1266	183
—	42	391	408	1312	190
—	44	411	422	1359	197
—	45	422	437	1420	206
—	46	433	452	1467	212
—	48	455	470	1513	219
—	50	479	497	1559	226
—	51	485	517	1621	235
—	52	497	532	1668	241
—	54	—	573	1729	250
—	56	—	609	1807	262
—	57	—	630	1884	273
—	59	—	670	1961	284
—	60	—	698	2039	295
—	61	—	725	—	—
—	62	—	740	—	—
—	63	—	780	—	—
—	64	—	812	—	—
—	65	—	847	—	—
—	66	—	885	—	—
—	67	—	926	—	—
—	68	—	971	—	—

Conversions from each scale are approximate

Table of Contents

KYOCERA SGS Precision Tools	2	HOLE MAKING	
KYOCERA SGS Precision Tools Europe Ltd. . . 4		High Performance Drills	224
Global Innovation Center	5	General Purpose Drills	284
Tooling Services	6	General Purpose Countersinks	310
Tech Hub	7	General Purpose Reamers	326
Medical Division	8	ROUTING	
Tool Wizard®	9	High Performance Routers	334
OVERVIEW		General Purpose Routers	348
Common Legend	11	TECHNICAL INFORMATION	
End Mill Legend	12	EDP Index	352
Drill Legend	13	KSPT Reference Information	369
Router Legend	14	Decimal Equivalent Chart	370
COATINGS	15	Hardness Conversion Chart	371
MILLING			
High Performance End Mills	16		
End Mill Matrix	22		
High Performance Aluminum End Mills . . . 122			
General Purpose End Mills	168		

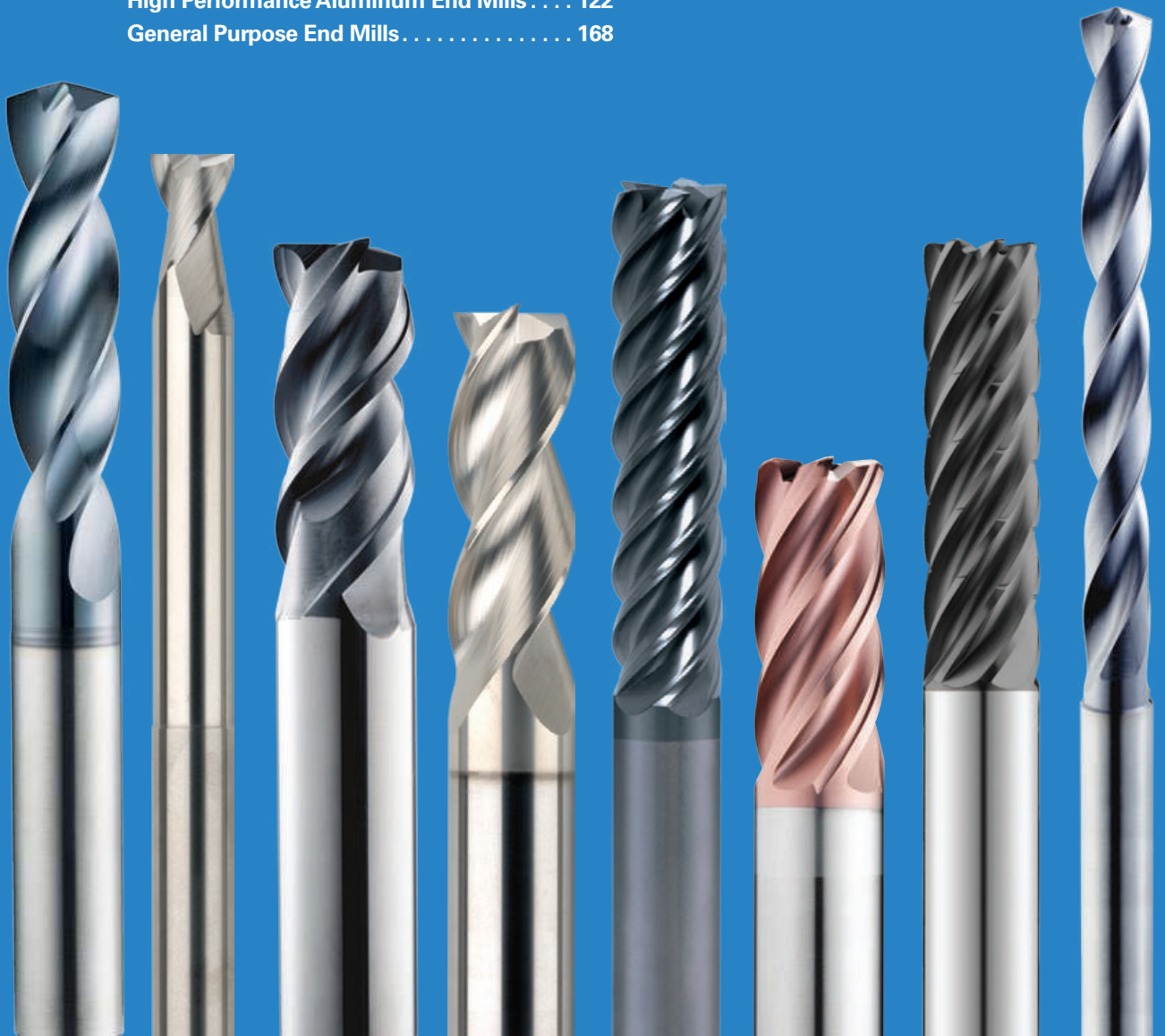



VALUE AT THE SPINDLE®



MORE THAN JUST ANOTHER CUTTING TOOL SUPPLIER

KYOCERA SGS PRECISION TOOLS EUROPE, LTD.

The state of the art KYOCERA SGS Precision Tools Europe facility is located in Wokingham, England and is focused on the manufacture of special cutting tools, high accuracy form tools, tool modifications and regrinds. A highly skilled team of professionals specialize in the supply and support of high performance tools for the Aerospace, Medical, Power Generation and Motorsport markets.

KYOCERA SGS Precision Tools Europe also offers a full range of end mill and drill products as follows:

- Multi-Million Euro Warehouse Stocking Full Range of Catalog Products
- Same Day Shipment on Stock Items
- Multi-Lingual Sales and Technical Support
- Online Portal for Stock Availability, Pricing, Discount Information and 24-Hour Order Placement
- High Performance Product and Application Training, Including the New KYOCERA SGS Tool Clinic

Additional services provided at this facility include:

- A Fast Track for Special Tools Via Our Rapid Response Centre
- Product Research and Development
- Product Engineering and Tool Application Support
- CAD/CAM Software Support





GLOBAL INNOVATION CENTER

INNOVATIVE CUTTING TOOL TECHNOLOGIES

The Global Innovation Center is an environment conducive to innovation. Through testing and development, the dedicated KYOCERA SGS Precision Tools Team focuses on the latest technical competence and machining techniques to bring a continuous stream of new products and advancements to market.

- Cutting Edge Equipment
- Highly Engineered Technology
- Incorporation of innovative machine tool technology for Research and Development

TECHNICAL TRAINING & EDUCATION

Our knowledge-based selling programs are specifically designed to challenge and educate by facilitating programs that mix classroom presentation with hands-on experience. Our own KSPT team members go through the same core training we provide to our valued distribution partners.

- KSPT Campus Tool Clinics
- On-Site Customer Training
- Basic, Advanced and Expert Level Material
- Market-Driven Knowledge

APPLICATION ENGINEERING

The KSPT expertise and global market knowledge allows us to translate customer needs into a commercial sales strategy. The portfolio of KSPT products and services offer an unparalleled track record in performance, cost savings, quality and value at the spindle.

- Market-Driven Productivity Improvements, including the Z-Carb HPR and S-Carb APR/APF®
- Tooling Solutions which include development of new tool geometries, extreme lab testing parameters and extensive field testing
- Technical Support and Troubleshooting
- Research and Development



TOOLING SERVICES

KSPT is committed to providing superior tooling services in the areas of Reconditioning, Recoating, Regrinding, Specials and Alterations. These services are offered to provide unique solutions and enhanced tool life with involvement from the KSPT Technical Support Team.

KSPT proudly offers Tooling Services in North America and Europe.



KSPT TOOLING SERVICES FACILITIES

UNITED STATES OF AMERICA KSPT

150 Marc Drive
Cuyahoga Falls, Ohio 44223 U.S.A.
customer service -
US and Canada: (330) 686-5700
fax - US & Canada: (800) 447-4017
international fax: (330) 686-2146

KYOCERA SGS Precision Tools West Coast Service Center

1814 W. Collins Ave.
Orange, California 92867
phone: (714) 363-3701
fax: (714) 363-3711
email: sgswest@kyocera-sgstool.com

EUROPE KSPTE

10 Ashville Way
Wokingham, Berkshire
RG41 2PL England
phone: (44) 1189-795-200
fax: (44) 1189-795-295
e-mail: SalesEU@kyocera-sgstool.com

KYOCERA SGS Precision Tools Tech Hub

149 Slayton Avenue
Danville, VA 24540
US and Canada: (434) 791-2020
Fax US & Canada: (434) 791-2044
web: www.kyocera-techhub.com



BEFORE

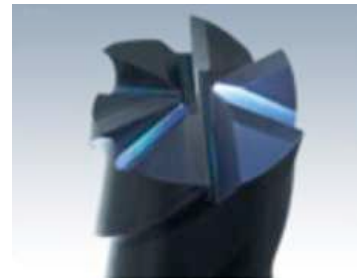

AFTER

KYOCERA SGS Tech Hub LLC

The KYOCERA SGS Tech Hub (KSTH) is an independent subsidiary of KYOCERA SGS Precision Tools Inc. created to focus on custom high-performance cutting tool solutions, while exploring emerging technologies. The state-of-the-art custom facility is designed with the purpose and resources to provide MORE than a cutting tool. KSTH provides a complete scope of services and works with customers to tailor solutions from conception to application and beyond.

SPECIAL CUTTING TOOL SOLUTIONS

KSTH considers each opportunity as a priority project and understands the challenges special tailored tooling present to our end users. Our sole focus is supporting a culture required for applying custom solutions yielding a return on investment with our technical expertise, close collaboration and effective communication. Besides KSTH providing quotation requests within a 24-hour period, we also offer:

- Aggressive Deliveries
- Improved Value Proposition
- Global Resources and Technology
- Full Project Proposal and Management
- Detailed Drawings
- Solid Models
- Process Plans
- Cutting Strategies and Simulations
- Quality Assurance Documentation (ISO 9001:2015 Certified)
- Testing and Validation
- Onsite Application and Optimization Support
- Cradle to Grave Product Support
- Constant Access to KSTH Staff

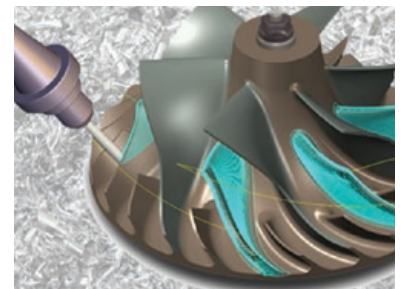
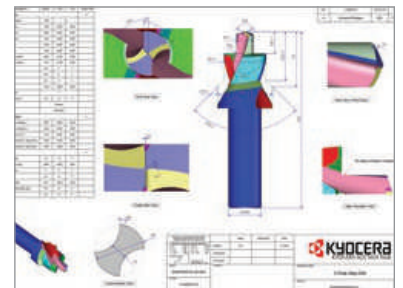

KYOCERA SGS Tech Hub LLC

149 Slayton Avenue

Danville, VA 24540

US and Canada: (434) 791-2020

Fax US & Canada: (434) 791-2044

web: www.kyocera-techhub.com





KYOCERA **SGS** Precision Tools Medical Division

WHO WE ARE

With over 20 years of industry experience, KSPT Medical produces unique, customer designed orthopedic devices using highly trained engineers dedicated to new technology. KSPT Medical is a division of KYOCERA SGS Precision Tools, who proudly pioneered some of the world's most advanced metal cutting technology and sells to more than 60 countries. With over 20 years of industry experience, KSPT Medical Division is ISO 13485:2016 Certified and is FDA Registered in the production of medical devices in the orthopedic marketplace.

ENGINEERING

We approach each opportunity as a project and manage it as such. We pride ourselves on engineering each project to the specific needs of our customers. Providing quotes often within 24 hours and following through with detailed drawings, solid models, process plans, and program simulations if needed. Our goal is to work hand in hand with the end user and maintain constant communication to customize our support to their needs.

MACHINING CAPABILITIES

- GRINDING
- MILLING
- TURNING
- PROFILING
- BENDING
- Services Offered; Welding, Various Coatings, Anodizing, Passivation, Electropolishing, Laser Etching and HeatTreating



KYOCERA **SGS** Precision Tools Medical Division

724 East Swihart Street
Columbia City, Indiana 46725
phone: (260) 244-7677
fax: (260) 244-7466

To Request a Quote:
rfq@kyocera-sgstool.com

Customer Service and Orders:
salesmd@kyocera-sgstool.com



REGISTERED **ISO 13485:2016 Certified**



VALUE AT THE SPINDLE[®]

An interactive and dynamic platform to help select the correct SGS tool for the operation and provide optimal machining parameters.

- A quick and reliable 3 step process:
 1. Choose the material
 2. Enter the application
 3. From the list of recommended results, choose the tool that best fits your machining needs
- Speed & Feed rates will be generated based on application parameters combined with the selected tool's capabilities in the desired material.

TO SIGN UP FOR THE TOOLWIZARD[®]:

1. Visit Toolwizard.kyocera-sgstool.com
2. Register for an account
3. Start calculating
4. Start saving!



 **Common Legend**
 **Leyenda habitual**
 **Légende commune**
 **Gemeinsame Legende**

TO ORDER: Please specify quantity and EDP number.

PARA SU PEDIDO: Por favor especifique cantidad y número de EDP.

POUR COMMANDER: Veuillez préciser la quantité et le code article EDP.

BESTELLEN: Bitte Menge und EDV-Nummer angeben.

RETURN POLICY: An RMA number must accompany all product returns.
Contact your Customer Service Representative for an RMA number.

DEVOLUCIONES: Todo material devuelto debe ir acompañado de un número de RMA correspondiente.
Para solicitarlo, póngase en contacto con su Representante de Atención al Cliente.

POLITIQUE DE RETOUR: Tous les produits retournés doivent être accompagnés d'un numéro RMA.
Contacter votre interlocuteur commercial pour obtenir un numéro RMA.

RÜCKNAHMEGARANTIE: Eine RMA-Nummer (Rücksendegenehmigung) muss bei allen Produktrücksendungen beiliegen.
Wenden Sie sich bitte an Ihren Kundendienstmitarbeiter für RMA-Nummer.

REGULATION SAFETY GLASSES SHOULD ALWAYS BE WORN WHEN USING HIGH-SPEED CUTTING EQUIPMENT

DEBEN USARSE GAFAS PROTECTORAS CUANDO SE UTILICEN EQUIPOS DE ALTA VELOCIDAD

DES LUNETTES DE SÉCURITE DOIVENT ÊTRE IMPÉRATIVEMENT PORTÉES LORS D'UTILISATION D'OUTILS À GRANDE VITESSE

BEI SCHNELL LAUFENDEN SPANABHEBENDEN MASCHINEN MÜSSEN IMMER DIE VORGESCHRIEBENEN SICHERHEITSBRILLEN GETRAGEN WERDEN



WARNING: This product can expose you to chemicals including Cobalt, which is known to the State of California to cause cancer. For more information go to www.p65warnings.ca.gov



ADVERTENCIA: Este producto puede exponerlo a químicos como el Cobalto, reconocido como cancerígeno en el estado de California. Para más información visite esta página web: www.p65warnings.ca.gov



ATTENTION: Ce produit vous expose aux produits chimiques incluant le Cobalt, qui est reconnu par l'Etat de Californie à être une cause de cancer. Pour plus d'information veuillez regarder sur: www.p65warnings.ca.gov



WARNUNG: Dieses Produkt kann Sie mit Chemikalien wie Kobalt aussetzen, das dem Staat Kalifornien als krebserregend bekannt ist. Für weitere Informationen, besuchen Sie: www.p65warnings.ca.gov

**INTELLECTUAL PROPERTY
PROPIEDAD INTELECTUAL
PROPRIÉTÉ INTELLECTUELLE
GEISTIGES EIGENTUM**

KYOCERA SGS Precision Tools holds more than 20 patents globally. Please visit our website at www.kyocera-sgstool.com to learn more.

KYOCERA SGS Precision Tools posee más de 20 patentes a nivel mundial. Para más información, visite nuestra página web www.kyocera-sgstool.com.

KYOCERA SGS Precision Tools possède plus de 20 brevets mondialement reconnus. Pour plus d'information, veuillez consulter notre site web www.kyocera-sgstool.com.

KYOCERA SGS Precision Tools besitzt mehr als 20 Patente weltweit. Bitte besuchen Sie unsere Webseite www.kyocera-sgstool.com für weitere Informationen.

Common Legend

Leyenda habitual

Légende commune

Gemeinsame Legende

MATERIALS MATERIALES MATÉRIAUX WERKSTOFFE



Steels
Aceros
Aciers
Stähle



Stainless Steels
Aceros Inoxidables
Aciers inoxydables
Nichtrostende Stähle



Cast Iron
Acero de Fundición
Fonte
Grauguss



High Temp Alloys
Aleaciones Termorresistentes
Alliages hautes températures
Warmfeste Legierungen



Titanium
Titanio
Titane
Titan



Non-Ferrous
No Férricos
Non Ferreux
Nichteisenmetalle



Plastics/Composites
Plásticos/Resinas
Plastiques/Composites
Kunststoffe/Verbundkunststoffe



Hardened Steels
Aceros Endurecidos
Aciers Trempés
Gehärteter Stahl

TOOL LENGTH LONGITUDES DE HERRAMIENTAS LONGUEUR DE L'OUTIL WERKZEUGLÄNGE



Stub
Corta
Court
Kurze Bauform



Regular
Media
Moyen
Standard



Long
Larga
Long
Lang



Long Reach Neck
Larga con cuello
Détalonnage longue
portée
Freischliff



Extra Long
Extra-larga
Extra-long
Extra-Lang

FLUTES FILOS DENTS SCHNEIDEN



2 Flutes
2 Filos
2 Dents
2 Schneiden



3 Flutes
3 Filos
3 Dents
3 Schneiden



4 Flutes
4 Filos
4 Dents
4 Schneiden



5 Flutes
5 Filos
5 Dents
5 Schneiden



6 Flutes
6 Filos
6 Dents
6 Schneiden



7 Flutes
7 Filos
7 Dents
7 Schneiden



8 Flutes
8 Filos
8 Dents
8 Schneiden



9 Flutes
9 Filos
9 Dents
9 Schneiden



10 Flutes
10 Filos
10 Dents
10 Schneiden



11 Flutes
11 Filos
11 Dents
11 Schneiden



12 Flutes
12 Filos
12 Dents
12 Schneiden

 **End Mill Legend**
 **Leyenda fresas**
 **Légende fraise**
 **Fräser-Legende**

END CONFIGURATIONS
CONFIGURACIONES DE LA PUNTA
FORME DE L'OUTIL EN BOUT
ENDENAUSFÜHRUNG



Ball
Esférica
Boule
Kugelkopf



Corner
Plana con
borde romo
Rayon
mit Eckenradius



Square
Plana
Non rayonné
Scharfkantig

SHANK TYPE
TIPO DE VÁSTAGO
TYPE DE TIGE
SCHAFTART



Common
Normal
Dégagée
Standard



Straight
Recto
Cylindrique
Gerade



Weldon Flat
Weldon plano
Méplat Weldon
Spannfläche

HELIX ANGLES
ANGULOS DE LAS HELICES
SPANWINKEL
ANGLES DE L'HÉLICE



Right Spiral
Hélice con corte
a la derecha
Hélice droite
Rechtsspirale



Left Spiral
Hélice con corte
a la izquierda
Hélice gauche
Linksspirale



Variable Right Spiral
Hélice con corte a
la derecha y ángulo
variable
Hélice droite variable
Rechtsspirale, variabel

COOLANT OPTIONS
OPCIONES DE REFRIGERACIÓN
OPTIONS DE REFOIDISSEMENT
KÜHLSCHMIERMITTEL-OPTIONEN



Internal Coolant
Refrigeración interna
Refroidissement interne
Innenkühlung



JetStream Coolant Slots
Ranuras de refrigeración
JetStream
Fentes de
refroidissement
JetStream
JetStream-
Kühlmittelschlitz

RAKE ANGLE
ANGULO DE DESPRENDIMIENTO
ANGLE DE COUPE
SPANWINKEL



Positive
Positivo
Positif
Positiv



Neutral
Neutro
Neutre
Neutral



Negative
Negativo
Négatif
Negativ



Variable
Variable
Variable
Variabel

ADDITIONAL GEOMETRY
GEOMETRÍAS ADICIONALES
GÉOMÉTRIE SUPPLÉMENTAIRE
WEITERE BAUFORMEN



Flute Spacing Unequal
Espaciado desigual de
los filos
Denture décalée
Nutenabstand Ungleich



Chip Breaker
Rompevirutas
Brise-copeaux
Spanteiler

All tools are in Right Cut Direction unless noted
 Todas las herramientas son con corte a la derecha a menos que se indique lo contrario
 Tous les outils ont une coupe à droite, sauf indications contraires
 Alle Werkzeuge sind rechtsschneidend, soweit nicht anders angegeben

Drill Legend

Leyenda brocas

Légende perçage

Bohrer-Legende

SHANK TYPE TIPO DE VÁSTAGO TYPE DE TIGE SCHAFTART



Common
Normal
Dégagée
Standard



Straight
Recto
Cylindrique
Gerade

REACH ALCANCE LONGUEUR NUTZLÄNGE

3xD

>3xD Reach
Alcance >3xD
>Longueur 3xD
>3xD Nutzlänge

5xD

5xD Reach
Alcance 5xD
Longueur 5xD
5xD Nutzlänge

8xD

8xD Reach
Alcance 8xD
Longueur 8xD
8xD Nutzlänge

HELIX ANGLES ANGULOS DE LAS HELICES ANGLES DE L'HÉLICE SPANWINKEL



Right Spiral
Hélice con corte
a la derecha
Hélice à droite
Rechtsspirale



None
Ninguno
Aucun
gerade genutet



Internal Coolant
Refrigeración interna
Refroidissement interne
Innenkühlung



External Coolant
Refrigeración externa
Refroidissement
externe
Auskühlung

POINT ANGLE ÁNGULO DE PUNTA POINT D'ANGLE SPITZENWINKEL



Drill Point
Angulo de la Punta
Point de perçage
Bohrspitze



Chamfer Angle
Ángulo de chaflán
Angle de chanfrein
Fasenwinkel

Router Legend Leyenda ranuradores Légende détourage Konturenfräser-Legende

SHANK TYPE TIPO DE VÁSTAGO TYPE DE TIGE SCHAFTART



Straight
Recto
Cylindrique
Gerade

RAKE ANGLE ANGULO DE DESPRENDIMIENTO ANGLE DE PENTE SPANWINKEL



Positive
Positivo
Positif
Positiv



Neutral
Neutro
Neutre
Neutral



Negative
Negativo
Négatif
Negativ



Variable
Variable
Variable
Variabel

HELIX ANGLES ANGULOS DE LAS HELICES ANGLES DE L'HÉLICE SPANWINKEL



Right Spiral
Hélice con corte
a la derecha
Hélice à droite
Rechtsspirale



Left Spiral
Hélice con corte
a la izquierda
Hélice à gauche
Linksspirale

ADDITIONAL GEOMETRY GEOMETRÍAS ADICIONALES GÉOMÉTRIE SUPPLÉMENTAIRE WEITERE BAUFORMEN



Left Hand Cut
Direction
Fresado sentido
izquierda
Coupe vers la
gauche
Rechtsschneidend



Right Hand Cut
Direction
Fresado sentido
derecha
Coupe vers la droite
Linksschneidend



Chip Breaker
Rompevirutas
Brise-copeaux
Spanbrecher



Drill Point
Angulo de la Punta
Point de perçage
Bohrspitze

Ti-NAMITE® and Di-NAMITE® Tool Coatings are specifically engineered for KSPT solid carbide rotary tools. The coating lineup includes proprietary processes that result in optimized tool life and increased speed and feed rates in a variety of applications.



	Coating	Identifying Color	Layer Structure	Thickness	Hardness (HV)	Coefficient of Friction (Fretting)	Thermal Stability	General Information
	Titanium Nitride (TiN)	gold	Multilayer	1–5 microns	2200	0.40–0.65	600°C / 1112°F	A general purpose coating with good adhesion and abrasion resistant properties. Suitable for a wide variety of materials.
	Aluminum Titanium Nitride (AlTiN)	dark grey	Nano structure	1–5 microns	3700	0.30	1100°C / 2010°F	Excellent thermal and chemical resistance allows for dry cutting and improvements in performance of carbide. The coating has a high hardness giving great protection against abrasive wear and erosion.
	Titanium DiBoride (TiB ₂)	light grey-silver	Monolayer	1–2 microns	4000	0.10–0.20	850°C / 1562°F	This ceramic based coating ensures a smooth surface and a low affinity to cold welding or edge build up, which makes it optimal for aluminum and copper applications. It has high toughness and high hardness.
	Titanium Carbonitride (TiCN)	pink-red	Multilayer	1–5 microns	3000	0.30–0.45	400°C / 752°F	A very wear resistant coating with high toughness and shock resistance. Good in interrupted cuts found in applications like milling.
	Proprietary (TX)	black	Nano Composite	1–5 microns	3600	0.45	1150°C / 2100°F	The structural design of Ti-Namite-X is adapted to meet a diverse range of applications; everything from high- and low-alloy steels to hardened materials (up to 65 HRC core hardness). Ti-Namite-X is suitable for operations which require high cutting speeds, high temperatures at the cutting edge, and high metal removal rates.
	Crystalline Diamond (Diamond)	black	Monolayer	6–20 microns	>8000	0.15–0.20	800°C / 1470°F	This is the hardest coating available with the best abrasion resistance. It is carbon based so it is limited in application capabilities. This coating is suitable for machining highly abrasive, non-ferrous materials such as CFRP and graphite.
	Proprietary (TM)	copper	Nano Composite	1–5 microns	3600	0.45	1150°C / 2100°F	Features include high wear resistance, reduced friction, and excellent prevention of edge build up. This coating provides superior material removal rates and tool life when used in high performance operations with difficult to machine materials like titanium.

Other coatings available upon request.

High Performance End Mills



Milling

HIGH PERFORMANCE END MILLS	SERIES	DESCRIPTION	PAGE
Z-Carb-HPR	Z5	5 Flute Rougher Square End Fractional	28
	Z5CR	5 Flute Rougher Corner Radius Fractional	28
	Z5MCR	5 Flute Rougher Corner Radius Metric	35
Z-Carb-AP	Z1PCR	4 Flute Variable Rake Corner Radius Fractional	39
	Z1PLC	4 Flute Variable Rake Long Reach Corner Radius Fractional	41
	Z1PLB	4 Flute Variable Rake Ball End Long Reach Fractional	42
	Z1MPCR	4 Flute Variable Rake Corner Radius Metric	45
	Z1MPIC	4 Flute Variable Rake Intermediate Reach Corner Radius Metric	46
	Z1MPLC	4 Flute Variable Rake Long Reach Corner Radius Metric	46
	Z-Carb	Z1	4 Flute Variable Geometry Square End Fractional
Z16CR		4 Flute Variable Geometry Corner Radius Fractional	49
Z1B		4 Flute Variable Geometry Ball End Fractional	50
Z1M		4 Flute Variable Geometry Square End Metric	53
Z1MB		4 Flute Variable Geometry Ball End Metric	54
Z-Carb-HTA	ZH1CR	4 Flute Variable Geometry High Temp Alloys Corner Radius Fractional	57
	ZH1MCR	4 Flute Variable Geometry High Temp Alloys Corner Radius Metric	59
	ZH1MCRS	4 Flute Variable Geometry High Temp Alloys Stub Corner Radius Metric	59
Z-Carb-MD	ZD1CR	4 Flute Variable Geometry Hard Materials Long Reach Corner Radius Fractional	61
	ZD1MCR	4 Flute Variable Geometry Hard Materials Long Reach Corner Radius Metric	61
V-Carb	55	5 Flute Finisher & Semi-Finisher Square End Fractional	63
	55CR	5 Flute Finisher & Semi-Finisher Corner Radius Fractional	63
	55M	5 Flute Finisher & Semi-Finisher Square End Metric	65
	55MCR	5 Flute Finisher & Semi-Finisher Corner Radius Metric	65
	55B	5 Flute Finisher & Semi-Finisher Ball End Fractional	68
	55MB	5 Flute Finisher & Semi-Finisher Ball End Metric	68
T-Carb®	51	6 Flute High Speed Machining Square End Fractional	74
	51CR	6 Flute High Speed Machining Corner Radius Fractional	74
	51L	6 Flute High Speed Machining Square End Long Reach Fractional	75
	51LC	6 Flute High Speed Machining Long Reach Corner Radius Fractional	75
	51M	6 Flute High Speed Machining Square End Metric	78
	51MCR	6 Flute High Speed Machining Corner Radius Metric	78
	51ML	6 Flute High Speed Machining Square End Long Reach Metric	79
	51MLC	6 Flute High Speed Machining Long Reach Corner Radius Metric	79

Speed & Feed Recommendations listed after each series

HIGH PERFORMANCE END MILLS	SERIES	DESCRIPTION	PAGE
H-Carb	77	7 Flute High Efficiency Square End Fractional	82
	77CR	7 Flute High Efficiency Corner Radius Fractional	82
	77M	7 Flute High Efficiency Square End Metric	84
	77MCR	7 Flute High Efficiency Corner Radius Metric	84
Multi-Carb	66	Multi-Flute Finisher Square End Fractional	90
	66CR	Multi-Flute Finisher Corner Radius Fractional	90
	66M	Multi-Flute Finisher Square End Metric	93
	66MCR	Multi-Flute Finisher Corner Radius Metric	93
Series 33	33CR	3 Flute Difficult to Machine Materials Corner Radius Fractional	97
	33MCR	3 Flute Difficult to Machine Materials Corner Radius Metric	100
Series 7	7	4 Flute Variable Geometry Long Length Square End Fractional	103
	7M	4 Flute Variable Geometry Long Length Square End Metric	103
	7B	4 Flute Variable Geometry Long Length Ball End Fractional	104
	7MB	4 Flute Variable Geometry Long Length Ball End Metric	104
Turbo-Carb	56B	2 Flute Contouring Long Reach Ball End Fractional	107
	56MB	2 Flute Contouring Long Reach Ball End Metric	107
Power-Carb®	57	6 Flute Finisher Square End Fractional	110
	57M	6 Flute Finisher Square End Metric	110
CFRP Slow Helix	27	4 Flute Slow Helix Square End Fractional	113
	27M	4 Flute Slow Helix Square End Metric	113
Picatinny Rail Tools		3 Flute Non-Ferrous Recoil Groove Tool Groove Fractional	116
		5 Flute Non-Ferrous Dovetail Form Tool Fractional	116
		3 Flute Ferrous Recoil Groove Tool Fractional	117
		5 Flute Ferrous Dovetail Form Tool Fractional	117

Speed & Feed Recommendations listed after each series

FRESAS DE ALTO RENDIMIENTO	SERIE	DESCRIPCIÓN	PÁGINA
Z-Carb-HPR	Z5	5 fillos, desbastador, punta cuadrada, fraccional	28
	Z5CR	5 fillos, desbastador, radio angulado, fraccional	28
	Z5MCR	5 fillos, desbastador, radio angulado, métrico	35
Z-Carb-AP	Z1PCR	4 fillos, inclinación variable, radio angulado, fraccional	39
	Z1PLC	4 fillos, inclinación variable, largo alcance, radio angulado, fraccional	41
	Z1PLB	4 fillos, inclinación variable, punta esférica, largo alcance, fraccional	42
	Z1MPCR	4 fillos, inclinación variable, radio angulado, métrico	45
	Z1MPIC	4 fillos, inclinación variable, medio alcance, radio angulado, métrico	46
	Z1MPLC	4 fillos, inclinación variable, largo alcance, radio angulado, métrico	46
	Z-Carb	Z1	4 fillos, geometría variable, punta cuadrada, fraccional
Z16CR		4 fillos, geometría variable, radio angulado, fraccional	49
Z1B		4 fillos, geometría variable, punta esférica, fraccional	50
Z1M		4 fillos, geometría variable, punta cuadrada, métrico	53
Z1MB		4 fillos, geometría variable, punta esférica, métrico	54
Z-Carb-HTA	ZH1CR	4 fillos, geometría variable, aleaciones termorresistentes, radio angulado, fraccional	57
	ZH1MCR	4 fillos, geometría variable, aleaciones termorresistentes, radio angulado, métrico	59
	ZH1MCRS	4 fillos, geometría variable, aleaciones termorresistentes, versión corta, radio angulado, métrico	59
Z-Carb-MD	ZD1CR	4 fillos, geometría variable, materiales duros, largo alcance, radio angulado, fraccional	61
	ZD1MCR	4 fillos, geometría variable, materiales duros, largo alcance, radio angulado, métrico	61
V-Carb	55	5 fillos, acabador y semiacabador, punta cuadrada, fraccional	63
	55CR	5 fillos, acabador y semiacabador, radio angulado, fraccional	63
	55M	5 fillos, acabador y semiacabador, punta cuadrada, métrico	65
	55MCR	5 fillos, acabador y semiacabador, radio angulado, métrico	65
	55B	5 fillos, acabador y semiacabador, punta esférica, fraccional	68
	55MB	5 fillos, acabador y semiacabador, punta esférica, métrico	68
T-Carb®	51	6 fillos, mecanizado de alta velocidad, punta cuadrada, fraccional	74
	51CR	6 fillos mecanizado de alta velocidad, radio angulado, fraccional	74
	51L	6 fillos, mecanizado de alta velocidad, punta cuadrada, largo alcance, fraccional	75
	51LC	6 fillos mecanizado de alta velocidad, largo alcance, radio angulado, fraccional	75
	51M	6 fillos, mecanizado de alta velocidad, punta cuadrada, métrico	78
	51MCR	6 fillos mecanizado de alta velocidad, radio angulado, métrico	78
	51ML	6 fillos, mecanizado de alta velocidad, punta cuadrada, largo alcance, métrico	79
	51MLC	6 fillos mecanizado de alta velocidad, largo alcance, radio angulado, métrico	79
	H-Carb	77	7 fillos de alta eficiencia, punta cuadrada, fraccional
77CR		7 fillos de alta eficiencia, radio angulado, fraccional	82
77M		7 fillos métrica de alta eficiencia, punta cuadrada, métrico	84
77MCR		7 fillos métrica de alta eficiencia, radio angulado, métrico	84
Multi-Carb	66	Filo múltiple, acabador, punta cuadrada, fraccional	90
	66CR	Filo múltiple, acabador, radio angulado, fraccional	90
	66M	Filo múltiple, acabador, punta cuadrada, métrico	93
	66MCR	Filo múltiple, acabador, radio angulado, métrico	93
Serie 33	33CR	3 fillos, materiales difíciles de mecanizar, radio angulado, fraccional	97
	33MCR	3 fillos, materiales difíciles de mecanizar, radio angulado, métrico	100
Serie 7	7	4 fillos, geometría variable, longitud larga, punta cuadrada, fraccional	103
	7M	4 fillos, geometría variable, longitud larga, punta cuadrada, métrico	103
	7B	4 fillos, geometría variable, longitud larga, punta esférica, fraccional	104
	7MB	4 fillos, geometría variable, longitud larga, punta esférica, métrico	104
Turbo-Carb	56B	2 fillos, contorneado, largo alcance, punta esférica, fraccional	107
	56MB	2 fillos, contorneado, largo alcance, punta esférica, métrico	107
Power-Carb®	57	6 fillos, acabador, punta cuadrada, fraccional	110
	57M	6 fillos, acabador, punta cuadrada, métrico	110
Helicoidal de avance lento CFRP	27	4 fillos, helicoidal de avance lento, punta cuadrada, fraccional	113
Herramientas de riel Picatinny	27M	4 fillos, helicoidal de avance lento, punta cuadrada, métrico	113
		Herramienta de ranura de retroceso no ferrosa de 3 fillos fraccional	116
		Herramienta de ranura de retroceso ferrosa de 3 fillos fraccional	116
		Herramienta de cola de milano ferrosa de 5 fillos fraccional	117
		Herramienta de cola de milano ferrosa de 5 fillos fraccional	117

Recomendaciones de velocidades y avances mostradas tras cada serie

FRAISES A DETOURER UNIVERSELLES	SÉRIES	DESCRIPTION	PAGE
Z-Carb-HPR	Z5	5 dents non rayonné pour l'ébauche (fractionnel)	28
	Z5CR	5 dents rayonnée pour l'ébauche (fractionnel)	28
	Z5MCR	5 dents rayonnée pour l'ébauche (métrique)	35
Z-Carb-AP	Z1PCR	4 dents pas décalé et hélice variable rayonnés (fractionnel)	39
	Z1PLC	4 dents pas décalé et hélice variable rayonnés (fractionnel)	41
	Z1PLB	4 dents à vague de coupe variable longue portée à bout hémisphérique (fractionnel)	42
	Z1MPCR	4 dents pas décalé et hélice variable rayonnés (métrique)	45
	Z1MPIC	4 dents pas décalé, hélice variable, détalonné, rayonnés (métrique)	46
	Z1MPLC	4 dents pas décalé et hélice variable rayonnés (métrique)	46
	Z-Carb	Z1	4 dents géométrie variable non rayonné (fractionnel)
Z16CR		4 dents géométrie variable rayonné (fractionnel)	49
Z1B		4 dents géométrie variable à bout hémisphérique (fractionnel)	50
Z1M		4 dents géométrie variable non rayonné (métrique)	53
Z1MB		4 dents géométrie variable à bout hémisphérique (métrique)	54
Z-Carb-HTA	ZH1CR	4 dents géométrie variable alliages haute température rayonné (fractionnel)	57
	ZH1MCR	4 dents géométrie variable alliages haute température rayonné (métrique)	59
	ZH1MCRS	4 dents géométrie variable, alliages haute température, longueur de l'outil court, rayonné (métrique)	59
Z-Carb-MD	ZD1CR	4 dents géométrie variable matériaux durs longue portée rayonné (fractionnel)	61
	ZD1MCR	4 dents géométrie variable matériaux durs longue portée rayonné (métrique)	61
V-Carb	55	5 dents en bout de finition et semi-finition plat (fractionnel)	63
	55CR	5 dents en bout finition et semi-finition rayonné (fractionnel)	63
	55M	5 dents en bout de finition et semi-finition plat (métrique)	65
	55MCR	5 dents en bout finition et semi-finition rayonné (métrique)	65
	55B	5 dents en bout de finition et semi-finition hémisphérique (fractionnel)	68
	55MB	5 dents en bout de finition et semi-finition hémisphérique (métrique)	68
T-Carb®	51	6 dents pour usinage grande vitesse non rayonné (fractionnel)	74
	51CR	6 dents pour usinage grande vitesse rayonné (fractionnel)	74
	51L	6 dents pour usinage grande vitesse non rayonné extra longue (fractionnel)	75
	51LC	6 dents pour usinage grande vitesse extra longue rayonné (fractionnel)	75
	51M	6 dents pour usinage grande vitesse non rayonné (métrique)	78
	51MCR	6 dents pour usinage grande vitesse rayonné (métrique)	78
	51ML	6 dents pour usinage grande vitesse non rayonné extra longue (métrique)	79
	51MLC	6 dents pour usinage grande vitesse extra longue rayonné (métrique)	79
H-Carb	77	7 dents hautes performances droite côtes (fractionnel)	82
	77CR	7 dents hautes performances torique côtes (fractionnel)	82
	77M	7 dents hautes performances droite côtes (métrique)	84
	77MCR	7 dents hautes performances torique côtes (métrique)	84
Multi-Carb	66	Multi-dents non rayonné pour finition (fractionnel)	90
	66CR	Multi-dents rayonné pour finition (fractionnel)	90
	66M	Multi-dents non rayonné pour finition (métrique)	93
	66MCR	Multi-dents rayonné pour finition (métrique)	93
Série 33	33CR	3 dents rayonné pour l'ébauche dans tous les matériaux sauf non-ferreux (fractionnel)	97
	33MCR	3 dents rayonné pour l'ébauche dans tous les matériaux sauf non-ferreux (métrique)	100
Série 7	7	4 dents géométrie variable à queue longue non rayonné (fractionnel)	103
	7M	4 dents géométrie variable à queue longue non rayonné (métrique)	103
	7B	4 dents géométrie variable à queue longue à bout hémisphérique (fractionnel)	104
	7MB	4 dents géométrie variable à queue longue à bout hémisphérique (métrique)	104
Turbo-Carb	56B	2 dents contournage longue portée à bout hémisphérique (fractionnel)	107
	56MB	2 dents contournage longue portée à bout hémisphérique (métrique)	107
Power-Carb®	57	6 dents en bout de finition plat (fractionnel)	110
	57M	6 dents en bout de finition plat (métrique)	110
CFRP hélice lente	27	4 dents hélice lente non rayonné (fractionnel)	113
	27M	4 dents hélice lente non rayonné (métrique)	113
Outils de rail Picatinny		Outil de rainure de recul non ferreux à 3 dents (fractionnel)	116
		Outil de forme en queue d'aronde non ferreux à 5 dents (fractionnel)	116
		Outil de rainure de recul ferreux à 3 dents (fractionnel)	117
		Outil en queue d'aronde ferreux à 5 dents (fractionnel)	117

Recommandativons de vitesse et avance indiquées après chaque série

HOCHLEISTUNGS-SCHAFTFRÄSER	SERIE	BESCHREIBUNG	SEITE	
Z-Carb-HPR	Z5	Zölliger Schruppfräser mit 5 Schneiden ohne Eckenradien	28	
	Z5CR	Zölliger Schruppfräser mit 5 Schneiden und Eckenradien	28	
	Z5MCR	Schruppfräser mit 5 Schneiden und Eckenradien	35	
Z-Carb-AP	Z1PCR	Zölliger Fräser mit 4 variablen Schneiden und Eckenradien	39	
	Z1PLC	Zölliger Langlochfräser mit 4 variablen Schneiden und Eckenradien	41	
	Z1PLB	Zölliger Radiuschaftfräser mit 4 Schneiden und variablem Spanwinkel	42	
	Z1MPCR	Fräser mit 4 Schneiden und variablen Spanwinkel	45	
	Z1MPIC	Fräser mittlerer Länge mit 4 variablen Schneiden und Eckenradien	46	
	Z1MPLC	Langlochfräser mit 4 variablen Schneiden und Eckenradien	46	
	Z1	Zölliger Schaftfräser mit 4 Schneiden ohne Eckenradien und variabler Form	49	
Z-Carb	Z16CR	Zölliger Fräser mit 4 variablen Schneiden und Eckenradien	49	
	Z1B	Zölliger Radiuschaftfräser mit 4 Schneiden und variabler Form	50	
	Z1M	Schaftfräser mit 4 Schneiden ohne Eckenradien und variabler Form	53	
	Z1MB	Radiuschaftfräser mit 4 Schneiden und variabler Form	54	
	Z1CR	Hochwarmfester zölliger Fräser mit 4 variablen Schneiden und Eckenradien	57	
Z-Carb-HTA	ZH1MCR	Hochwarmfester Fräser mit 4 variablen Schneiden und Eckenradien	59	
	ZH1MCRS	Hochwarmfester Fräser mit 4 variablen Schneiden und Eckenradien	59	
	ZD1CR	Zölliger Langlochfräser mit 4 variablen Schneiden, Eckenradien und Form aus Hartmetall	61	
Z-Carb-MD	ZD1MCR	Langlochfräser mit 4 variablen Schneiden, Eckenradien und Form aus Hartmetall	61	
V-Carb	55	Zölliger Schlicht- und Halbschlichtfräser mit 5 Schneiden ohne Eckenradien und variabler Form	63	
	55CR	Zölliger Schlicht- und Halbschlichtfräser mit 5 Schneiden ohne Eckenradien	63	
	55M	Schlicht- und Halbschlichtfräser mit 5 Schneiden ohne Eckenradien und variabler Form	65	
	55MCR	Schlicht- und Halbschlichtfräser mit 5 Schneiden und Eckenradien	65	
	55B	Schlicht- und Halbschlicht-Radiuschaftfräser mit 5 Schneiden ohne Eckenradien	68	
	55MB	Schlicht- und Halbschlicht-Radiuschaftfräser mit 5 Schneiden und variabler Form	68	
	T-Carb®	51	Zölliger Schaftfräser für die Hochgeschwindigkeitsbearbeitung mit 6 Schneiden ohne Eckenradien	74
		51CR	Zölliger Fräser für die Hochgeschwindigkeitsbearbeitung mit 6 Schneiden und Eckenradien	74
		51L	Zölliger Langloch-Schaftfräser aus Schnellstahl mit 6 Schneiden ohne Eckenradien	75
		51ML	Langloch-Schaftfräser aus Schnellstahl mit 6 Schneiden ohne Eckenradien	75
51M		Schaftfräser für die Hochgeschwindigkeitsbearbeitung mit 6 Schneiden ohne Eckenradien	78	
51MCR		Fräser für die Hochgeschwindigkeitsbearbeitung mit 6 Schneiden und Eckenradien aus Schnellstahl	78	
51LC		Zölliger Langlochfräser für die Hochgeschwindigkeitsbearbeitung mit 6 Schneiden und Eckenradien	79	
51MLC		Langlochfräser für die Hochgeschwindigkeitsbearbeitung mit 6 Schneiden und Eckenradien	79	
H-Carb		77	Zölliger Hocheffizienter mit 7 Schneiden ohne Eckenradien	82
		77CR	Zölliger Hocheffizienter mit 7 Schneiden und Eckenradien	82
	77M	Hocheffizienter mit 7 Schneiden ohne Eckenradien	84	
	77MCR	Hocheffizienter mit 7 Schneiden und Eckenradien	84	
	Multi-Carb	66	Zölliger mehrschneidiger Schlichtfräser ohne Eckenradien	90
66CR		Zölliger mehrschneidiger Schlichtfräser mit Eckenradien	90	
66M		mehrschneidiger Schlichtfräser ohne Eckenradien	93	
66MCR		mehrschneidiger Schlichtfräser mit Eckenradien	93	
Serie 33	33CR	Zölliger Fräser mit 3 Schneiden und Eckenradien für schwerspanbare Werkstoffe	97	
	33MCR	Fräser mit 3 Schneiden und Eckenradien für schwerspanbare Werkstoffe	100	
Serie 7	7	Zölliger Langloch-Schaftfräser mit 4 Schneiden ohne Eckenradien und variabler Form	103	
	7M	Langloch-Schaftfräser mit 4 Schneiden ohne Eckenradien und variabler Form	103	
	7B	Zölliger Langloch-Radiuschaftfräser mit 4 Schneiden und variabler Form	104	
	7MB	Langloch-Radiuschaftfräser mit 4 Schneiden und variabler Form	104	
Turbo-Carb	56B	Zölliger Langloch-Profil-Radiuschaftfräser mit 2 Schneiden	107	
	56MB	Langloch-Profil-Radiuschaftfräser mit 2 Schneiden	107	
Power-Carb®	57	Zölliger Schlichtfräser mit 6 Schneiden ohne Eckenradien	110	
	57M	Schlichtfräser mit 6 Schneiden ohne Eckenradien	110	
CFRP Slow Helix	27	Zölliger Schaftfräser mit 4 steilen Schneiden ohne Eckenradien	113	
	27M	Schaftfräser mit 4 steilen Schneiden ohne Eckenradien	113	
Picatinny Schienenwerkzeuge		3 Flöte Nichteisen-Rückstoßnut Nut Grove Bruchteil	116	
		5 Flöte Nichteisen-Schwalbenschwanzform-Werkzeug Bruchteil	116	
		3 Rillen-Eisenrückstoß-Nutwerkzeug fraktioniert	117	
		5 Flöte Eisen Schwalbenschwanz Werkzeug gebrochen	117	

Empfehlungen für Drehzahl & Vorschub im Anhang zu jeder Serie

End Mill Matrix

SGS End Mill Matrix					Preferred Cut Type for Series • Good •• Better ••• Best Not Recommended					Toolpath Preference* 1st 2nd	Flute Count						
Name	Series	Page	Material					Heavy	Moderate			Light	Fine	Finish			
Series 33	33	97	Steel P0 to P6	Stainless Steel M1 to M3	Cast Iron K1 to K3	High Temp Alloy S1 to S3	Titanium Alloy S4	Hardened Steel H1 to H4	Non Ferrous N1 to N4	Non Ferrous N5 to N7	•••	•••	••	••	•	Standard HEM	3
Z-Carb	Z1	49	Steel P0 to P6	Stainless Steel M1 to M3	Cast Iron K1 to K3	High Temp Alloy S1 to S3	Titanium Alloy S4	Hardened Steel H1 to H4	Non Ferrous N1 to N4	Non Ferrous N5 to N7	•••	•••	••	••	•	Standard HEM	4
Z-Carb-AP	Z1P	39	Steel P0 to P6	Stainless Steel M1 to M3	Cast Iron K1 to K3	High Temp Alloy S1 to S3	Titanium Alloy S4	Hardened Steel H1 to H4	Non Ferrous N1 to N4	Non Ferrous N5 to N7	•••	•••	••	••	•	Standard HEM	4
Z-Carb-HTA	ZH1	57	Steel P0 to P6	Stainless Steel M1 to M3	Cast Iron K1 to K3	High Temp Alloy S1 to S3	Titanium Alloy S4	Hardened Steel H1 to H4	Non Ferrous N1 to N4	Non Ferrous N5 to N7	•••	•••	••	••	•	Standard HEM	4
Series 7	7	103	Steel P0 to P6	Stainless Steel M1 to M3	Cast Iron K1 to K3	High Temp Alloy S1 to S3	Titanium Alloy S4	Hardened Steel H1 to H4	Non Ferrous N1 to N4	Non Ferrous N5 to N7	•	•	•	•••	•••	HEM Standard	4
Z-Carb HPR	Z5	28	Steel P0 to P6	Stainless Steel M1 to M3	Cast Iron K1 to K3	High Temp Alloy S1 to S3	Titanium Alloy S4	Hardened Steel H1 to H4	Non Ferrous N1 to N4	Non Ferrous N5 to N7	••	•••	•••	••	•	HEM Standard	5
V-Carb	55	63	Steel P0 to P6	Stainless Steel M1 to M3	Cast Iron K1 to K3	High Temp Alloy S1 to S3	Titanium Alloy S4	Hardened Steel H1 to H4	Non Ferrous N1 to N4	Non Ferrous N5 to N7	•	••	•••	•••	•••	HEM Standard	5
T-Carb®	51	74	Steel P0 to P6	Stainless Steel M1 to M3	Cast Iron K1 to K3	High Temp Alloy S1 to S3	Titanium Alloy S4	Hardened Steel H1 to H4	Non Ferrous N1 to N4	Non Ferrous N5 to N7	•	•	••	•••	•••	HEM Standard	6
H-Carb	77	82	Steel P0 to P6	Stainless Steel M1 to M3	Cast Iron K1 to K3	High Temp Alloy S1 to S3	Titanium Alloy S4	Hardened Steel H1 to H4	Non Ferrous N1 to N4	Non Ferrous N5 to N7	•	•	•	•••	•••	HEM Standard	7
Multi Carb	66	90	Steel P0 to P6	Stainless Steel M1 to M3	Cast Iron K1 to K3	High Temp Alloy S1 to S3	Titanium Alloy S4	Hardened Steel H1 to H4	Non Ferrous N1 to N4	Non Ferrous N5 to N7	•	•	•	••	•••	HEM Standard	7, 9, 11
Turbo Carb	56B	107	Steel P0 to P6	Stainless Steel M1 to M3	Cast Iron K1 to K3	High Temp Alloy S1 to S3	Titanium Alloy S4	Hardened Steel H1 to H4	Non Ferrous N1 to N4	Non Ferrous N5 to N7	•	•	••	•••	•••	HEM Standard	2
Z-Carb-MD	ZD1	61	Steel P0 to P6	Stainless Steel M1 to M3	Cast Iron K1 to K3	High Temp Alloy S1 to S3	Titanium Alloy S4	Hardened Steel H1 to H4	Non Ferrous N1 to N4	Non Ferrous N5 to N7	•••	•••	••	••	••	Standard HEM	4
Power-Carb®	57	110	Steel P0 to P6	Stainless Steel M1 to M3	Cast Iron K1 to K3	High Temp Alloy S1 to S3	Titanium Alloy S4	Hardened Steel H1 to H4	Non Ferrous N1 to N4	Non Ferrous N5 to N7	•	•	••	•••	•••	HEM Standard	6
Ski-Carb	44	163	Steel P0 to P6	Stainless Steel M1 to M3	Cast Iron K1 to K3	High Temp Alloy S1 to S3	Titanium Alloy S4	Hardened Steel H1 to H4	Non Ferrous N1 to N4	Non Ferrous N5 to N7	••	••	••	•••	•••	Standard HEM	2
S-Carb® 2 Flute	47	157	Steel P0 to P6	Stainless Steel M1 to M3	Cast Iron K1 to K3	High Temp Alloy S1 to S3	Titanium Alloy S4	Hardened Steel H1 to H4	Non Ferrous N1 to N4	Non Ferrous N5 to N7	•••	•••	••	••	•	Standard HEM	2
S-Carb® 3 Flute	43	136	Steel P0 to P6	Stainless Steel M1 to M3	Cast Iron K1 to K3	High Temp Alloy S1 to S3	Titanium Alloy S4	Hardened Steel H1 to H4	Non Ferrous N1 to N4	Non Ferrous N5 to N7	•••	•••	••	••	•	Standard HEM	3
S-Carb® Chipbreaker	43CB	146	Steel P0 to P6	Stainless Steel M1 to M3	Cast Iron K1 to K3	High Temp Alloy S1 to S3	Titanium Alloy S4	Hardened Steel H1 to H4	Non Ferrous N1 to N4	Non Ferrous N5 to N7	•••	•••	••	••	NR	Standard HEM	3
S-Carb® APR-3®	43APR-3	127	Steel P0 to P6	Stainless Steel M1 to M3	Cast Iron K1 to K3	High Temp Alloy S1 to S3	Titanium Alloy S4	Hardened Steel H1 to H4	Non Ferrous N1 to N4	Non Ferrous N5 to N7	•••	•••	••	••	NR	Standard HEM	3
S-Carb APR-4®	43APR-4	130	Steel P0 to P6	Stainless Steel M1 to M3	Cast Iron K1 to K3	High Temp Alloy S1 to S3	Titanium Alloy S4	Hardened Steel H1 to H4	Non Ferrous N1 to N4	Non Ferrous N5 to N7	•••	•••	••	••	NR	Standard HEM	4
S-Carb APF®	43APF	132	Steel P0 to P6	Stainless Steel M1 to M3	Cast Iron K1 to K3	High Temp Alloy S1 to S3	Titanium Alloy S4	Hardened Steel H1 to H4	Non Ferrous N1 to N4	Non Ferrous N5 to N7	•	•	••	•••	•••	Standard HEM	4
Slow Helix	27	113	Steel P0 to P6	Stainless Steel M1 to M3	Cast Iron K1 to K3	High Temp Alloy S1 to S3	Titanium Alloy S4	Hardened Steel H1 to H4	Non Ferrous N1 to N4	Non Ferrous N5 to N7	•	•	••	•••	•••	Standard HEM	4
CCR	20-CCR	338	Steel P0 to P6	Stainless Steel M1 to M3	Cast Iron K1 to K3	High Temp Alloy S1 to S3	Titanium Alloy S4	Hardened Steel H1 to H4	Non Ferrous N1 to N4	Non Ferrous N5 to N7	•••	•••	••	••	NR	Standard HEM	5, 8, 10, 12
CCR	31-CCR	342	Steel P0 to P6	Stainless Steel M1 to M3	Cast Iron K1 to K3	High Temp Alloy S1 to S3	Titanium Alloy S4	Hardened Steel H1 to H4	Non Ferrous N1 to N4	Non Ferrous N5 to N7	•••	•••	••	••	NR	Standard HEM	5, 7, 8, 10
Compression Router	25	345	Steel P0 to P6	Stainless Steel M1 to M3	Cast Iron K1 to K3	High Temp Alloy S1 to S3	Titanium Alloy S4	Hardened Steel H1 to H4	Non Ferrous N1 to N4	Non Ferrous N5 to N7	•	•	••	••	•••	Standard HEM	4, 6, 8
Up Cut Router	21	348	Steel P0 to P6	Stainless Steel M1 to M3	Cast Iron K1 to K3	High Temp Alloy S1 to S3	Titanium Alloy S4	Hardened Steel H1 to H4	Non Ferrous N1 to N4	Non Ferrous N5 to N7	•••	•••	••	••	•	Standard HEM	2
Down Cut Router	22	349	Steel P0 to P6	Stainless Steel M1 to M3	Cast Iron K1 to K3	High Temp Alloy S1 to S3	Titanium Alloy S4	Hardened Steel H1 to H4	Non Ferrous N1 to N4	Non Ferrous N5 to N7	•	•	••	••	•••	Standard HEM	2

Preferred materials for each Series are highlighted above

Cut depths (Ae & Ap) are based on a percentage of the cutter diameter (DC)

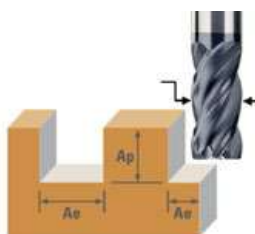

Material	Heavy 100%~40% Ae ≤ 100% Ap	Moderate 100%~40% Ae ≤ 150% Ap	Light 25%~10% Ae ≤ 250% Ap	Fine 10%~2% Ae ≤ 450% Ap	Finish 2%~0% Ae any Ap
Steel P0 to P6	•	•	•	•	•
Stainless Steel M1 to M3	•	•	•	•	•
Cast Iron K1 to K3	•	•	•	•	•
High Temp Alloy S1 to S3	•	•	•	•	•
Titanium Alloy S4	•	•	•	•	•
Hardened Steel H1 to H4	•	•	•	•	•
Non Ferrous N1 to N4	•	•	•	•	•
Non Ferrous N5 to N7	•	•	•	•	•

• Coolant required in these materials
 • Plunging not recommended in these materials

Material hardness and machinability affect speed, feed, and cut depths

Long flute or long reach tools require reduced rates and cut depth

Unless marked "NR", a high quality finish can be achieved with any Series tool with adjustments to speed and feed

End Mill Matrix

Cut Diameter Range inch mm	Cut Length Availability (x DC)**	Reach Option (x DC)**	End Styles Square Radius Ball	Chipbreaker Option	Shank Option Solid Round, Weldon Flat, Jet Stream, Coolant Hole	Center Cutting	Maximum Recommended Ramp Angle ***	Helix Angle	Flute Index	Coating
0.125 to 1 3 to 20	2.25 to 3	–	R	By Request	SR, WF	Yes	90	32 / 48	Unequal	Ti-Namite-A
0.125 to 1 3 to 25	1.25 to 3	–	R, B	By Request	SR, WF, JS	Yes	90	35 / 38	Unequal	Ti-Namite-A
0.0156 to 1 1 to 25	1 to 3.25	2.5 to 8.5	S, R, B	By Request	SR, WF, JS	Yes	90	35 / 38	Unequal	Ti-Namite-X
0.250 to 1 6 to 20	1.25 to 3	–	R	By Request	SR, WF	Yes	20	38 / 41	Unequal	Ti-Namite-A
0.125 to 1 3 to 25	2.25 to 8.25	–	S, B	By Request	SR	Yes	1	38	Unequal	Ti-Namite-A
0.125 - 1 6 - 25	1 to 3	–	S, R	By Request	SR, WF, CH	No	7	37	Unequal	Ti-Namite-M Ti-Namite-A
0.125 - 1 6 - 20	1.25 to 5	–	S, R, B	By Request	SR, WF	Yes	5	45	Unequal	Ti-Namite-A
0.250 to 1 6 to 20	1.25 to 3	3.25 to 5.5	S, R	By Request	SR	Yes	3	41	Unequal	Ti-Namite-X
0.250 to 1 6 to 25	2.5 to 4	–	S, R	In Stock Available	SR	No	1	37	Unequal	Ti-Namite-M Ti-Namite-A
0.188 to 1 6 to 25	1.5 to 3.25	–	S, R	By Request	SR	No	1	35	Equal	Ti-Namite-A
0.031 to 0.750 1 to 20	1	2 to 2.25	B	By Request	SR	Yes	25	30	Equal	Ti-Namite-A
0.118 to 0.750 5 to 20	1 to 1.25	2.25 to 5	R	By Request	SR	Yes	2	42 / 45	Unequal	Ti-Namite-A
0.250 to 0.500 6 to 20	2 to 2.25	–	S	By Request	SR	Yes	1	45	Equal	Ti-Namite-A
0.250 to 1 3 to 20	1.25 to 7	–	S, R	By Request	SR, WF	Yes	90	45	Equal	Ti-Namite-B
0.125 to 1 3 to 25	1 to 3	3 to 9	S, B	By Request	SR	Yes	90	35	Equal	Ti-Namite-B
0.125 to 1 3 to 25	1 to 7	2.25 to 8.5	S, R, B	By Request	SR	Yes	90	38	Equal	Ti-Namite-B
0.250 to 1 6 to 20	1 to 7	2.5 to 8.5	R	Standard	SR	Yes	90	38	Equal	Ti-Namite-B
0.750 to 1 12 to 26	1.25 to 1.75	3 to 4	S, R	Standard	CH	Yes	90	38	Unequal	Ti-Namite-B
20 to 25	1.25 to 1.75	2.25 to 3.5	S, R	Standard	CH	Yes	90	38 / 41	Unequal	Ti-Namite-B
0.500 to 0.750 6 to 25	2.5 to 4	3 to 5	S, R	By Request	CH	Yes	25	38 / 41	Unequal	Ti-Namite-B
0.250 to 0.750 6 to 16	1.75 to 4	–	S	By Request	SR	Yes	5	10, 12	Unequal	Di-Namite (optional)
0.250 to 0.500 2 to 12	2.75 to 4	–	S	Standard	SR	Based upon end style	5 (for end cut styles)	15	Equal	Di-Namite (optional)
0.250 to 0.500 6 to 12	2.75 to 4	–	S	Standard	SR	Based upon end style	5 (for end cut styles)	15	Equal	Di-Namite (optional)
0.250 to 0.500 6 to 12	2.75 to 4	–	S	By Request	SR	Yes	5	30	Equal	Di-Namite (optional)
0.125 to 0.750 3 to 12	2.5 to 4.25	–	S	By Request	SR	Yes	90	35	Equal	various optional
0.125 to 0.750 3 to 12	2.5 to 4.25	–	S	By Request	SR	Yes	–	35	Equal	various optional



Standard Toolpath



HEM Toolpath

* HEM toolpaths are usually preferred in most situations. However, standard paths may be more efficient with moderate to heavy cut types

** some variations of Cut Length and Reach are based upon Cut Diameter

*** shown is general recommendation for most materials, lower ramp angles are required for materials with lower machinability

For complete application recommendations refer to the SGS Tool Wizard®



Application Tips

Tool	<ul style="list-style-type: none"> • Whenever possible, select an end mill with the largest diameter, shortest flute length, and shortest overall length for the best rigidity • Long flute tools are not intended for pocketing, slotting, or heavy profiling – limit Ae to .02D • High Performance tools minimize cycle time and extend tool life
Tool Holders	<ul style="list-style-type: none"> • Holders with adequate gripping pressure and TIR are required • Stub holders or zero length collet style holders are recommended for heavy stock removal • When using solid holders, hand ground screw flats are not recommended
Workpiece	<ul style="list-style-type: none"> • Secure clamping of the workpiece will reduce chatter and deflection
Machine	<ul style="list-style-type: none"> • Spindle must be in optimum condition for precise TIR and maximum tool life • Sufficient horsepower is required to perform at recommended speeds and feeds • Reduce rates for low power machines to prevent workpiece and / or tool damage
Coolant	<ul style="list-style-type: none"> • Avoid re-milling chips through use of air blast or liquid coolant as necessary • Maintain clean coolant with appropriate concentration • General recommendations: <ul style="list-style-type: none"> —Water Soluble Oil or Air Blast: Tool Steels, Mold & Die Steels, Carbon or Alloy Steels —Water Soluble Oil: Stainless Steels, Titanium, High Temperature Alloys, Non-Ferrous Alloys
Methods	<ul style="list-style-type: none"> • Climb milling is generally preferred • Attention to programming details, tool holders, TIR, balance, fixturing, etc. improve cutting tool performance and extend tool life

END MILLING GUIDELINE

DC = cutting diameter APMX = flute length

Speeds and Feeds for Cut Types are based on Radial Width (A_e) and Axial Depth (A_p)

Reductions to Speeds and Feeds may be necessary when:

- Ae and Ap exceed recommendations
- Using long flute or extended reach tools
- Using long tool holders
- Machining materials harder than listed

ENTRY METHODS

Pre-Drilled Hole



Pre-drilling is the preferred entry method for most applications.

Helical Ramp



Straight Ramp

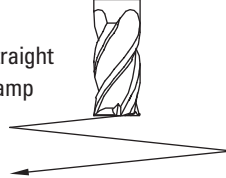

Alternative methods are helical and straight ramping. High ramp angles require reduced feed. Lower ramp angles will allow higher feed rates and extend tool life. Use slotting speeds and feeds for ramp angles of 1° to 2°. Reduce feed to 25% when ramp angles approach 6°. General purpose tools and/or difficult to machine materials will require lower ramp angles and reduced feed.

Plunge



Plunge only in non-ferrous and short-chipping materials using slotting speeds and 25% slotting feeds.

Herramientas	<ul style="list-style-type: none"> • Siempre que sea posible, seleccione la herramienta de mayor diámetro y menor longitud total y de filo para obtener una mayor rigidez. • Las herramientas con filos largos no son recomendadas para operaciones de apertura de cajas en el maquinado, operación de ranurado o perfilado pesado – limitar la profundidad radial (Ae) a .02D • Las herramientas de alto desempeño minimizan el tiempo de ciclo del maquinado y extienden la vida útil de la herramienta
Portaherramientas	<ul style="list-style-type: none"> • Los Portaherramientas deberán tener buena presión de amarre para la sujeción de la herramienta y una concentricidad máxima indicada (TIR) • Se recomienda usar portaherramientas de amarre directo cortos, o de boquilla con longitud cero para lograr un máximo arranque de viruta • Cuando se utilicen portaherramientas de amarre directo, no se recomienda hacer manualmente el plano para la sujeción del tornillo en el zanco de la herramienta
Pieza a maquinar	<ul style="list-style-type: none"> • La buena sujeción de la pieza a maquinar reducirá la vibración y la desviación de la herramienta
Máquina	<ul style="list-style-type: none"> • El husillo de la máquina debe estar en condiciones óptimas, para asegurar la concentricidad de giro (TIR) y asegurar el máximo rendimiento de la herramienta • Para lograr los avances y velocidades recomendados, se necesita suficiente potencia (HP) en la máquina • Reducir los parámetros de corte en máquinas de baja potencia (HP) para prevenir el daño en la herramienta o pieza de trabajo
Refrigeración	<ul style="list-style-type: none"> • Evite el re-maquinado de virutas usando aire a presión o líquido refrigeración según sea necesario • Mantener limpio la refrigeración con su concentración adecuada • Recomendaciones generales: <ul style="list-style-type: none"> –Para el maquinado de aceros de herramienta, para Moldes y Dados o Aleaciones de Bajo Carbón, utilice Aceite Soluble en Agua o aire a presión –Para el maquinado de Aleaciones Inoxidables, Aleaciones Termorresistentes, Titanio y Aleaciones No Ferrosas, utilice solamente Aceite Soluble en Agua
Métodos	<ul style="list-style-type: none"> • Se recomienda el maquinado en sentido ascendente o trepado • El cuidado en los detalles de la programación, la concentricidad de giro (TIR) el balance de los portaherramientas, la sujeción de la pieza a maquinar, etc. son factores que contribuyen a prolongar la vida de la herramienta

GUÍAS DE FRESADO

DC = diámetro de corte APMX = largo de filo

Las velocidades y avances para cortes están basados en la profundidad radial (A_e), y profundidad axial (A_p)

Reducciones en velocidades y avances serán necesarias cuando:

- A_e y A_p exceda las recomendaciones
- Se utilicen filos largos o herramientas de largo alcance
- Se utilicen portaherramientas largos
- Se maquinen materiales más duros que los recomendados

MÉTODOS DE ENTRADA

Barreno previo



Preferentemente usar un barreno previo como método de entrada para la mayor parte de las aplicaciones.

Rampa helicoidal



Rampa recta



Los métodos alternativos son las rampas helicoidales y rectas. Un ángulo elevado de rampa necesita un avance reducido. Un ángulo de rampa inferior permitirá tasas de avance más elevadas y una mayor duración de la herramienta. Usar velocidades y alcances de ranurado para ángulos de rampa de 1° a 2°. Disminuir el avance un 25% cuando los ángulos de rampa se aproximan a 6°. Las herramientas de uso general y/o materiales difíciles de mecanizar precisarán ángulos de rampa inferiores y un avance reducido.

Agujero o Barrenado



Este método se puede utilizar únicamente en materiales no ferrosos y materiales de formación de virutas cortas, usando la velocidad de ranurado y el 25% de su avance.

Conseils relatifs à l'application

Outil	<ul style="list-style-type: none"> • Chaque fois que possible, choisissez une fraise de plus grand diamètre possible, la plus courte possible, elle garantira la meilleure rigidité • Les outils longs ne sont pas optimum pour l'ébauche, le pocketing, le rainurage – Ae limité à 0,02 D • Les outils Haute performance optimisent les temps de cycle et de augmentent la durée de vie
Porte-outils	<ul style="list-style-type: none"> • Des attachements à serrage puissant et à faux rond précis sont recommandés • Attachements à méplats ou pinces à serrage nominale sont recommandées pour les ébauches • Lorsque vous utilisez des attachement rigides, les serrage de l'outil par vis ne sont pas recommandés
Pièce	<ul style="list-style-type: none"> • Le système de fixation et de bridage de la pièce devra permettre de réduire les vibrations et la déformation
Machine	<ul style="list-style-type: none"> • Broche doit être en bon état optimal au niveau de son faux rond • Suffisamment puissance est nécessaire pour effectuer à des vitesses recommandées et se nourrit • Réduire les efforts pour les machines de faible puissance pour éviter l'endommagement de la pièce et / ou de l'outil
Liquide de refroidissement	<ul style="list-style-type: none"> • Évitez le recyclage de copeaux par l'utilisation de soufflage d'air comprimé ou de liquide de refroidissement. • Maintenir le lubrifiant propre à la concentration appropriée • Recommandations générales – <ul style="list-style-type: none"> –Huile soluble ou Air comprimé: aciers à outils, aciers pour moules, aciers au carbone ou alliés –Huile soluble: aciers inoxydables, titane, alliages à haute température, alliages non ferreux
Méthodes	<ul style="list-style-type: none"> • L'usinage en avalant est généralement préconisé • Attention à la programmation, porte-outils, faux rond, équilibrage, fixation, etc améliorent les performances de l'outil en coupe et prolonge la durée de vie

GUIDE DU FRAISAGE

DC = diamètre de coupe APMX = longueur de coupe

Vitesses & avances pour ces cas d'usinage sont basées sur l'engagement radial (A_e), et axial (A_p)

La réduction de la vitesse et de l'avance doit être nécessaire quand:

- Les engagements A_e et A_p sont importants
- Des dentures longues ou des séries longues sont utilisées
- Des attachement longs sont utilisés
- Lors d'usinage de matériaux durs

TYPES D'ENTREE MATIERE

Preperçage



Le préperçage est la méthode préférable dans la plupart de applications.

Ramping hélicoïdal



Ramping droit

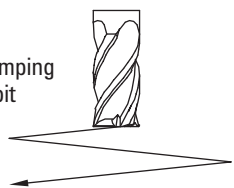

Les autres méthodes sont un ramping hélicoïdal et un ramping droit. Les angles de ramping élevés exigent une avance inférieure. Les angles de ramping inférieurs permettent les taux d'avance supérieurs et prolongeront la vie de l'outil. Utilisez des avances et vitesses de mortaisage pour les angles de ramping de 1° à 2°. Réduisez l'avance à 25 % lorsque les angles de ramping avoisinent 6°. Les outils tout usage et/ou les matériaux difficiles à usiner exigeront des angles de ramping inférieurs et une charge réduite.

Plongée



Plongée uniquement dans les non ferreux. Vitesse rainurage et avances réduites de 25%.

Werkzeug	<ul style="list-style-type: none"> • Wählen Sie möglichst immer den Schafffräser mit dem größten Durchmesser, der kürzesten Schneide und Gesamtlänge, um eine hohe Steifigkeit zu erhalten • Langlochschaftfräser sind nicht zum Taschen-, Schlitz- oder Profilfräsen bestimmt – die Dehnung auf Ae 0,2 der Streckgrenze nicht überschreiten • Hochleistungswerkzeuge minimieren die Bearbeitungszeit und verlängern die Werkzeugstandzeit
Werkzeughalter	<ul style="list-style-type: none"> • Es werden Spannzangen mit genauem Rundlauf benötigt • Steilkegel oder bündige Spannfutter werden bei hohem Materialabtrag empfohlen • Von der Verwendung fester handverschraubter Halterungen wird abgeraten
Werkstück	<ul style="list-style-type: none"> • Sicheres Werkzeugspannen verringert Vibrationen und das Auswandern aus der Spannvorrichtung
Werkzeugmaschine	<ul style="list-style-type: none"> • Die Spindel muss in optimalem Zustand sein, um einen genauen Rundlauf und maximale Standzeit zu erzielen • Für die empfohlenen Drehzahlen und Vorschubgeschwindigkeiten ist genügend Leistung bereitzustellen • Bei leistungsschwachen Antrieben sind die Werte zu verringern, um Beschädigungen am Werkstück und/oder Werkzeug zu vermeiden
Kühlmittel	<ul style="list-style-type: none"> • Das Stauen der Späne durch Luftstrahl oder flüssige Kühlmittel möglichst verhindern • Kühlmittel in geeigneter Konzentration verwenden • Allgemeine Empfehlungen: <ul style="list-style-type: none"> – Wasser-Öl-Emulsionen oder Luftstrahl: Werkzeugstähle, Form- und Schneidstähle, unlegierte oder legierte Stähle – Wasser-Öl-Emulsion: Nichtrostender Stahl, Titan, Warmfeste Legierungen, Nichteisenlegierungen
Verfahren	<ul style="list-style-type: none"> • Vorzugsweise Gleichlaufräsen anwenden • Das Beachten der Fräsparameter, Werkzeughalter, Rundlauf, Auswuchten, Einspannen, usw. verbessert die Schnittleistung und verlängert die Standzeit

RICHTWERTE ZUM FRÄSEN

DC = Fräsdurchmesser APMX = Schnittlänge

Drehzahl und Vorschub für Fräsarbeiten hängen von Radialbreite (A_e) und Frästiefe (A_p) ab

Drehzahl und Vorschub müssen ggfs. verringert werden wenn:

- die empfohlenen Werte für Ae und Ap überschritten werden
- lange Schneiden oder Langschaftfräser verwendet werden
- lange Werkzeughalter verwendet werden
- die Werkstoffe härter als vorgesehen sind

VORBEREITUNGEN

Vorbohrung



Vorbohren ist in den meisten Fällen ratsam.

Zirkulareintauchfräsen



Schrägeintauchfräsen



Alternative Verfahren sind Zirkulareintauchen und Schrägeintauchen. Starke Tauchwinkel erfordern verringerte Vorschubgeschwindigkeiten. Geringe Tauchwinkel ermöglichen höhere Vorschubgeschwindigkeiten und verlängern die Standzeit. Verwenden Sie die Drehzahlen und Vorschübe zum Schlitzfräsen für Tauchwinkel von 1° bis 2°. Den Vorschub auf 25 % verringern, wenn der Tauchwinkel 6° erreicht. Standardwerkzeuge und / oder schwer zu bearbeitende Werkstoffe verlangen kleine Tauchwinkel und verringerte Vorschubgeschwindigkeiten.

Stechen



Stechen Sie in Nichteisenmetalle und kurzspannende Werkstoffe nur mit Schlitzfräsdrehzahl und 25 % der Schlitzvorschubgeschwindigkeit ein.

FRACTIONAL Z-Carb-HPR

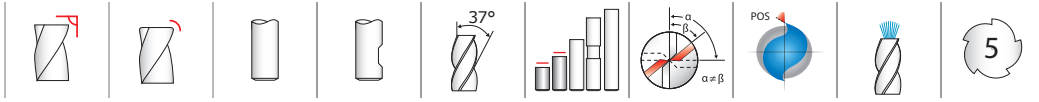

Z5 • Z5CR FRACTIONAL SERIES

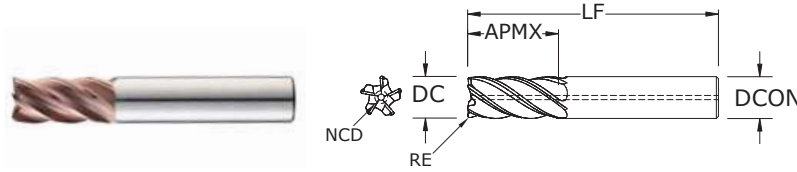

TOLERANCES (inch)

1/8–1/4 DIAMETER
DC = +0.0000/–0.0012
DCON = h_6
RE = +0.0000/–0.0020
>1/4–3/8 DIAMETER
DC = +0.0000/–0.0016
DCON = h_6
RE = +0.0000/–0.0020
>3/8–1 DIAMETER
DC = +0.0000/–0.0020
DCON = h_6
RE = +0.0000/–0.0020

- An ideal balance of helix, indexing, flute depth, rake and relief
- Variable indexing for chatter suppression and patented edge geometry for shearing and strength
- Chatter-free geometry allows deep cutting and high speed machining
- Central coolant hole delivers coolant effectively to the cutting zone enhancing chip removal when pocketing or slotting
- Excels at roughing, ramping, high speed machining and finishing in a variety of materials
- Enhanced corner geometry with tight tolerance corner radii
- Recommended for materials ≤ 45 HRc (≤ 420 Bhn)

- STEELS
- STAINLESS STEELS
- CAST IRON
- HIGH TEMP ALLOYS
- TITANIUM
- HARDENED STEELS

For patent information visit www.ksptpatents.com

inch						EDP NO.					
CUTTING DIAMETER DC	LENGTH OF CUT APMX	OVERALL LENGTH LF	SHANK DIAMETER DCON	CORNER RADIUS RE	NON-CUTTING CENTER DIAMETER NCD	TI-NAMITE-A (TA)	TI-NAMITE-A (TA) W/FLAT	TI-NAMITE-A (TA) W/INTERNAL COOLANT	TI-NAMITE-M (TM)	TI-NAMITE-M (TM) W/FLAT	TI-NAMITE-M (TM) W/INTERNAL COOLANT
1/8	1/4	1-1/2	1/8	–	0.0440	38500	–	–	37000	–	–
1/8	1/4	1-1/2	1/8	0.010	0.0440	38771	–	–	38770	–	–
1/8	1/4	1-1/2	1/8	0.015	0.0440	38525	–	–	37001	–	–
1/8	1/4	1-1/2	1/8	0.030	0.0440	38773	–	–	38772	–	–
1/8	3/8	1-1/2	1/8	–	0.0440	37180	–	–	37002	–	–
1/8	3/8	1-1/2	1/8	0.010	0.0440	38775	–	–	38774	–	–
1/8	3/8	1-1/2	1/8	0.015	0.0290	37181	–	–	37003	–	–
1/8	3/8	1-1/2	1/8	0.030	0.0290	38777	–	–	38776	–	–
3/16	5/16	2	3/16	–	0.0660	38501	–	–	37004	–	–
3/16	5/16	2	3/16	0.010	0.0660	38779	–	–	38778	–	–
3/16	5/16	2	3/16	0.015	0.0660	38526	–	–	37005	–	–
3/16	5/16	2	3/16	0.030	0.0660	38781	–	–	38780	–	–
3/16	1/2	2	3/16	–	0.0660	37182	–	–	37006	–	–
3/16	1/2	2	3/16	0.010	0.0660	38783	–	–	38782	–	–
3/16	1/2	2	3/16	0.015	0.0660	37183	–	–	37007	–	–
3/16	1/2	2	3/16	0.030	0.0660	38785	–	–	38784	–	–
1/4	3/8	2-1/2	1/4	–	0.0880	38502	–	–	37008	–	–
1/4	3/8	2-1/2	1/4	0.010	0.0880	38787	–	–	38786	–	–
1/4	3/8	2-1/2	1/4	0.015	0.0880	38527	–	–	37009	–	–
1/4	3/8	2-1/2	1/4	0.030	0.0880	38528	–	–	37010	–	–
1/4	3/8	2-1/2	1/4	0.060	0.0750	38789	–	–	38788	–	–
1/4	3/8	2-1/2	1/4	0.090	0.0880	38791	–	–	38790	–	–
1/4	1/2	2-1/2	1/4	–	0.0880	37184	–	–	37011	–	–
1/4	1/2	2-1/2	1/4	0.010	0.0880	38793	–	–	38792	–	–
1/4	1/2	2-1/2	1/4	0.015	0.0880	37185	–	–	37012	–	–
1/4	1/2	2-1/2	1/4	0.030	0.0880	37186	–	–	37013	–	–
1/4	1/2	2-1/2	1/4	0.060	0.0750	38795	–	–	38794	–	–
1/4	1/2	2-1/2	1/4	0.090	0.0880	38797	–	–	38796	–	–

continued on next page

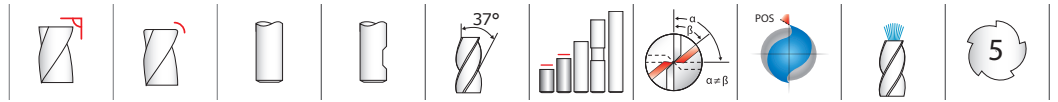

TOLERANCES (inch)

1/8-1/4 DIAMETER

DC = +0.0000/-0.0012

DCON = h₆

RE = +0.0000/-0.0020

>1/4-3/8 DIAMETER

DC = +0.0000/-0.0016

DCON = h₆

RE = +0.0000/-0.0020

>3/8-1 DIAMETER

DC = +0.0000/-0.0020

DCON = h₆

RE = +0.0000/-0.0020

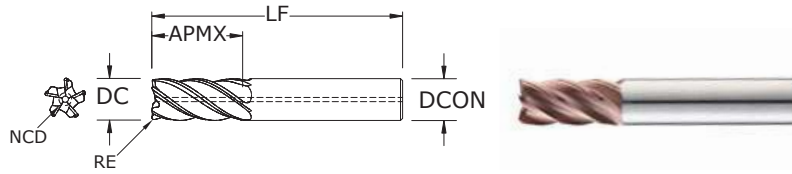

Z5 • Z5CR
FRACTIONAL SERIES

inch						EDP NO.					
CUTTING DIAMETER DC	LENGTH OF CUT APMX	OVERALL LENGTH LF	SHANK DIAMETER DCON	CORNER RADIUS RE	NON-CUTTING CENTER DIAMETER NCD	TI-NAMITE-A (TA)	TI-NAMITE-A (TA) W/FLAT	TI-NAMITE-A (TA) W/INTERNAL COOLANT	TI-NAMITE-M (TM)	TI-NAMITE-M (TM) W/FLAT	TI-NAMITE-M (TM) W/INTERNAL COOLANT
5/16	7/16	2-1/2	5/16	-	0.1090	38503	-	-	37014	-	-
5/16	7/16	2-1/2	5/16	0.010	0.1090	38799	-	-	38798	-	-
5/16	7/16	2-1/2	5/16	0.015	0.1090	38529	-	-	37015	-	-
5/16	7/16	2-1/2	5/16	0.030	0.1090	38801	-	-	38800	-	-
5/16	7/16	2-1/2	5/16	0.060	0.1090	38803	-	-	38802	-	-
5/16	7/16	2-1/2	5/16	0.090	0.0640	38805	-	-	38804	-	-
5/16	5/8	2-1/2	5/16	-	0.1090	38504	-	-	37016	-	-
5/16	5/8	2-1/2	5/16	0.010	0.0640	38807	-	-	38806	-	-
5/16	5/8	2-1/2	5/16	0.015	0.1090	38530	-	-	37017	-	-
5/16	5/8	2-1/2	5/16	0.030	0.1090	38809	-	-	38808	-	-
5/16	5/8	2-1/2	5/16	0.060	0.1090	38811	-	-	38810	-	-
5/16	5/8	2-1/2	5/16	0.090	0.0640	38813	-	-	38812	-	-
3/8	1/2	2-1/2	3/8	-	0.1310	38505	-	-	37018	-	-
3/8	1/2	2-1/2	3/8	0.010	0.1310	38815	-	-	38814	-	-
3/8	1/2	2-1/2	3/8	0.015	0.1310	38531	-	-	37019	-	-
3/8	1/2	2-1/2	3/8	0.030	0.1310	38532	-	-	37020	-	-
3/8	1/2	2-1/2	3/8	0.060	0.1310	38817	-	-	38816	-	-
3/8	1/2	2-1/2	3/8	0.090	0.0830	38819	-	-	38818	-	-
3/8	3/4	2-1/2	3/8	-	0.1310	37187	-	-	37021	-	-
3/8	3/4	2-1/2	3/8	0.010	0.1310	38821	-	-	38820	-	-
3/8	3/4	2-1/2	3/8	0.015	0.1310	37188	-	-	37022	-	-
3/8	3/4	2-1/2	3/8	0.030	0.1310	37189	37174	-	37023	-	-
3/8	3/4	2-1/2	3/8	0.060	0.1310	38823	-	-	38822	-	-
3/8	3/4	2-1/2	3/8	0.090	0.0830	38825	-	-	38824	-	-
7/16	5/8	2-1/2	7/16	0.015	0.1530	37164	-	-	37160	-	-
7/16	5/8	2-1/2	7/16	0.030	0.1530	37165	-	-	37161	-	-
7/16	7/8	2-3/4	7/16	0.015	0.1530	37166	-	-	37162	-	-
7/16	7/8	2-3/4	7/16	0.030	0.1530	37167	-	-	37163	-	-

CONTINUED

continued on next page

FRACTIONAL Z-Carb-HPR

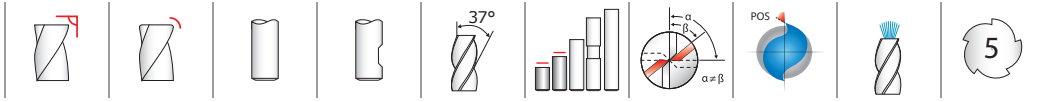

Z5 • Z5CR FRACTIONAL SERIES

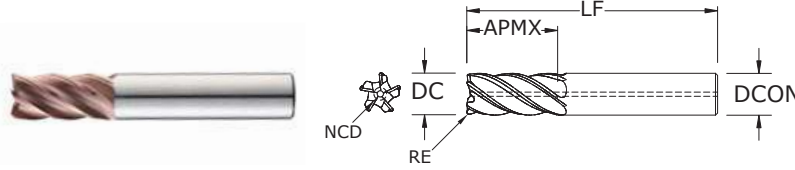

TOLERANCES (inch)

1/8-1/4 DIAMETER
DC = +0.0000/-0.0012
DCON = h ₆
RE = +0.0000/-0.0020
>1/4-3/8 DIAMETER
DC = +0.0000/-0.0016
DCON = h ₆
RE = +0.0000/-0.0020
>3/8-1 DIAMETER
DC = +0.0000/-0.0020
DCON = h ₆
RE = +0.0000/-0.0020

CONTINUED

- An ideal balance of helix, indexing, flute depth, rake and relief
- Variable indexing for chatter suppression and patented edge geometry for shearing and strength
- Chatter-free geometry allows deep cutting and high speed machining
- Central coolant hole delivers coolant effectively to the cutting zone enhancing chip removal when pocketing or slotting
- Excels at roughing, ramping, high speed machining and finishing in a variety of materials
- Enhanced corner geometry with tight tolerance corner radii
- Recommended for materials ≤ 45 HRc (≤ 420 Bhn)

- STEELS
- STAINLESS STEELS
- CAST IRON
- HIGH TEMP ALLOYS
- TITANIUM
- HARDENED STEELS

For patent information visit www.kspatents.com

inch						EDP NO.					
CUTTING DIAMETER DC	LENGTH OF CUT APMX	OVERALL LENGTH LF	SHANK DIAMETER DCON	CORNER RADIUS RE	NON-CUTTING CENTER DIAMETER NCD	TI-NAMITE-A (TA)	TI-NAMITE-A (TA) W/FLAT	TI-NAMITE-A (TA) W/INTERNAL COOLANT	TI-NAMITE-M (TM)	TI-NAMITE-M (TM) W/FLAT	TI-NAMITE-M (TM) W/INTERNAL COOLANT
1/2	5/8	3	1/2	-	0.1750	38506	38512	37320	37024	37030	37321
1/2	5/8	3	1/2	0.010	0.1750	38827	38829	38831	38826	38828	38830
1/2	5/8	3	1/2	0.015	0.1750	38533	38578	37330	37025	37031	37331
1/2	5/8	3	1/2	0.030	0.1750	38534	38579	37332	37026	37032	37333
1/2	5/8	3	1/2	0.060	0.1750	38535	38580	37334	37027	37033	37335
1/2	5/8	3	1/2	0.090	0.1750	38536	38581	37337	37028	37034	37338
1/2	5/8	3	1/2	0.120	0.1750	38537	38582	37339	37029	37035	37340
1/2	1	3	1/2	-	0.1750	38507	38513	37322	37036	37042	37323
1/2	1	3	1/2	0.010	0.1750	38833	38835	38837	38832	38834	38836
1/2	1	3	1/2	0.015	0.1750	38538	38583	37341	37037	37043	37342
1/2	1	3	1/2	0.030	0.1750	38539	38584	37343	37038	37044	37344
1/2	1	3	1/2	0.060	0.1750	38540	38585	37345	37039	37045	37346
1/2	1	3	1/2	0.090	0.1750	38541	38586	37348	37040	37046	37349
1/2	1	3	1/2	0.120	0.1750	38542	38587	37350	37041	37047	37351
1/2	1-1/4	3-1/4	1/2	-	0.1750	37190	37194	37325	37048	37054	37324
1/2	1-1/4	3-1/4	1/2	0.010	0.1750	38839	38841	38843	38838	38840	38842
1/2	1-1/4	3-1/4	1/2	0.015	0.1750	37191	37195	37352	37049	37055	37353
1/2	1-1/4	3-1/4	1/2	0.030	0.1750	37192	37196	37354	37050	37056	37355
1/2	1-1/4	3-1/4	1/2	0.060	0.1750	37193	37197	37356	37051	37057	37357
1/2	1-1/4	3-1/4	1/2	0.090	0.1750	38543	38588	37359	37052	37058	37360
1/2	1-1/4	3-1/4	1/2	0.120	0.1750	38544	38589	37361	37053	37059	37362
5/8	3/4	3-1/2	5/8	-	0.2630	38508	38514	38518	37060	37067	37260
5/8	3/4	3-1/2	5/8	0.010	0.2190	38845	38847	38849	38844	38846	38848
5/8	3/4	3-1/2	5/8	0.015	0.2190	38545	38590	38623	37061	37068	37261
5/8	3/4	3-1/2	5/8	0.030	0.2190	38546	38591	38624	37062	37069	37262
5/8	3/4	3-1/2	5/8	0.060	0.2190	38547	38592	38625	37063	37070	37263
5/8	3/4	3-1/2	5/8	0.090	0.2190	38548	38593	38626	37064	37071	37264
5/8	3/4	3-1/2	5/8	0.120	0.2190	38549	38594	38627	37065	37072	37265
5/8	3/4	3-1/2	5/8	0.190	0.2190	38550	38595	38628	37066	37073	37266
5/8	1-1/4	3-1/2	5/8	-	0.2190	37198	37202	38519	37074	37081	37267

continued on next page



FRACTIONAL Z-Carb-HPR

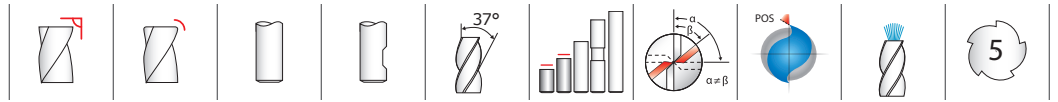

TOLERANCES (inch)

1/8-1/4 DIAMETER

DC = +0.0000/-0.0012

DCON = h_6

RE = +0.0000/-0.0020

>1/4-3/8 DIAMETER

DC = +0.0000/-0.0016

DCON = h_6

RE = +0.0000/-0.0020

>3/8-1 DIAMETER

DC = +0.0000/-0.0020

DCON = h_6

RE = +0.0000/-0.0020

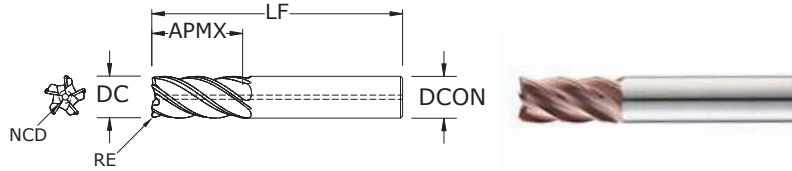

**Z5 •
Z5CR**
FRACTIONAL SERIES

inch						EDP NO.					
CUTTING DIAMETER DC	LENGTH OF CUT APMX	OVERALL LENGTH LF	SHANK DIAMETER DCON	CORNER RADIUS RE	NON-CUTTING CENTER DIAMETER NCD	TI-NAMITE-A (TA)	TI-NAMITE-A (TA) W/FLAT	TI-NAMITE-A (TA) W/INTERNAL COOLANT	TI-NAMITE-M (TM)	TI-NAMITE-M (TM) W/FLAT	TI-NAMITE-M (TM) W/INTERNAL COOLANT
5/8	1-1/4	3-1/2	5/8	0.010	0.2190	38851	38853	38855	38850	38852	38854
5/8	1-1/4	3-1/2	5/8	0.015	0.2190	37199	37203	38629	37075	37082	37268
5/8	1-1/4	3-1/2	5/8	0.030	0.2190	37200	37204	38630	37076	37083	37269
5/8	1-1/4	3-1/2	5/8	0.060	0.2190	37201	37205	38631	37077	37084	37270
5/8	1-1/4	3-1/2	5/8	0.090	0.2190	38551	38596	38632	37078	37085	37271
5/8	1-1/4	3-1/2	5/8	0.120	0.2190	38552	38597	38633	37079	37086	37272
5/8	1-1/4	3-1/2	5/8	0.190	0.2190	38553	38598	38634	37080	37087	37273
3/4	7/8	4	3/4	-	0.2630	38509	38515	38520	37088	37095	37274
3/4	7/8	4	3/4	0.010	0.2630	38857	38859	38861	38856	38858	38860
3/4	7/8	4	3/4	0.030	0.2630	38554	38599	38635	37089	37096	37275
3/4	7/8	4	3/4	0.060	0.2630	38555	38600	38636	37090	37097	37276
3/4	7/8	4	3/4	0.090	0.2630	38556	38601	38637	37091	37098	37277
3/4	7/8	4	3/4	0.120	0.2630	38557	38602	38638	37092	37099	37278
3/4	7/8	4	3/4	0.190	0.2630	38558	38603	38639	37093	37100	37279
3/4	7/8	4	3/4	0.250	0.2630	38559	38604	38640	37094	37101	37280
3/4	1-1/2	4	3/4	-	0.2630	37206	37210	38521	37102	37109	37281
3/4	1-1/2	4	3/4	0.010	0.2630	38863	38865	38867	38862	38864	38866
3/4	1-1/2	4	3/4	0.030	0.2630	37207	37211	38641	37103	37110	37282
3/4	1-1/2	4	3/4	0.060	0.2630	37208	37212	38642	37104	37111	37283
3/4	1-1/2	4	3/4	0.090	0.2630	38560	38605	38643	37105	37112	37284
3/4	1-1/2	4	3/4	0.120	0.2630	37209	37213	38644	37106	37113	37285
3/4	1-1/2	4	3/4	0.190	0.2630	38561	38606	38645	37107	37114	37286
3/4	1-1/2	4	3/4	0.250	0.2630	38562	38607	38646	37108	37115	37287
3/4	1-5/8	4	3/4	0.030	0.2630	37222	-	-	37223	-	-
3/4	1-5/8	4	3/4	0.060	0.2630	37224	-	-	37225	-	-
3/4	1-5/8	4	3/4	0.090	0.2630	37226	-	-	37227	-	-
3/4	1-5/8	4	3/4	0.120	0.2630	37228	-	-	37229	-	-
3/4	2	4-1/2	3/4	0.030	0.2630	37230	-	-	37231	-	-
3/4	2	4-1/2	3/4	0.060	0.2630	37232	-	-	37233	-	-
3/4	2	4-1/2	3/4	0.090	0.2630	37234	-	-	37235	-	-

continued on next page

FRACTIONAL Z-Carb-HPR

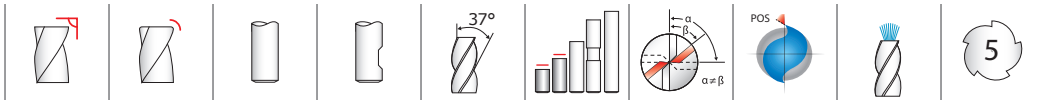

Z5 • Z5CR FRACTIONAL SERIES

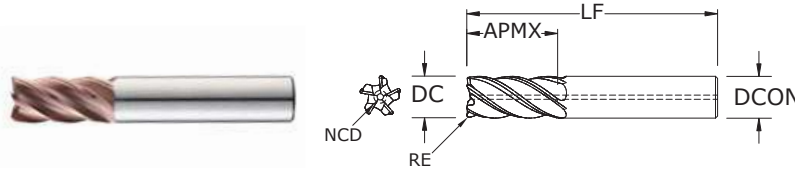

TOLERANCES (inch)

1/8–1/4 DIAMETER
DC = +0.0000/–0.0012
DCON = h_6
RE = +0.0000/–0.0020
>1/4–3/8 DIAMETER
DC = +0.0000/–0.0016
DCON = h_6
RE = +0.0000/–0.0020
>3/8–1 DIAMETER
DC = +0.0000/–0.0020
DCON = h_6
RE = +0.0000/–0.0020

CONTINUED

- An ideal balance of helix, indexing, flute depth, rake and relief
- Variable indexing for chatter suppression and patented edge geometry for shearing and strength
- Chatter-free geometry allows deep cutting and high speed machining
- Central coolant hole delivers coolant effectively to the cutting zone enhancing chip removal when pocketing or slotting
- Excels at roughing, ramping, high speed machining and finishing in a variety of materials
- Enhanced corner geometry with tight tolerance corner radii
- Recommended for materials ≤ 45 HRC (≤ 420 Bhn)

- STEELS
- STAINLESS STEELS
- CAST IRON
- HIGH TEMP ALLOYS
- TITANIUM
- HARDENED STEELS

For patent information visit www.kspatents.com

inch						EDP NO.					
CUTTING DIAMETER DC	LENGTH OF CUT APMX	OVERALL LENGTH LF	SHANK DIAMETER DCON	CORNER RADIUS RE	NON-CUTTING CENTER DIAMETER NCD	TI-NAMITE-A (TA)	TI-NAMITE-A (TA) W/FLAT	TI-NAMITE-A (TA) W/INTERNAL COOLANT	TI-NAMITE-M (TM)	TI-NAMITE-M (TM) W/FLAT	TI-NAMITE-M (TM) W/INTERNAL COOLANT
3/4	2	4-1/2	3/4	0.120	0.2630	37236	—	—	37237	—	—
1	1-1/8	4	1	—	0.3500	38510	38516	38522	37116	37123	37288
1	1-1/8	4	1	0.010	0.3500	38869	38871	38873	38868	38870	38872
1	1-1/8	4	1	0.030	0.3500	38563	38608	38647	37117	37124	37289
1	1-1/8	4	1	0.060	0.3500	38564	38609	38648	37118	37125	37290
1	1-1/8	4	1	0.090	0.3500	38565	38610	38649	37119	37126	37291
1	1-1/8	4	1	0.120	0.3500	38566	38611	38650	37120	37127	37292
1	1-1/8	4	1	0.190	0.3500	38567	38612	38651	37121	37128	37293
1	1-1/8	4	1	0.250	0.3500	38568	38613	38652	37122	37129	37294
1	1-1/2	4	1	—	0.3500	37214	37218	38523	37130	37137	37295
1	1-1/2	4	1	0.010	0.3500	38875	38877	38879	38874	38876	38878
1	1-1/2	4	1	0.030	0.3500	37215	37219	38653	37131	37138	37296
1	1-1/2	4	1	0.060	0.3500	37216	37220	38654	37132	37139	37297
1	1-1/2	4	1	0.090	0.3500	38569	38614	38655	37133	37140	37298
1	1-1/2	4	1	0.120	0.3500	37217	37221	38656	37134	37141	37299
1	1-1/2	4	1	0.190	0.3500	38570	38615	38657	37135	37142	37300
1	1-1/2	4	1	0.250	0.3500	38571	38616	38658	37136	37143	37301
1	2	4-1/2	1	—	0.3500	38511	38517	38524	37144	37151	37302
1	2	4-1/2	1	0.010	0.3500	38881	38883	38885	38880	38882	38884
1	2	4-1/2	1	0.030	0.3500	38572	38617	38659	37145	37152	37303
1	2	4-1/2	1	0.060	0.3500	38573	38618	38660	37146	37153	37304
1	2	4-1/2	1	0.090	0.3500	38574	38619	38661	37147	37154	37305
1	2	4-1/2	1	0.120	0.3500	38575	38620	38662	37148	37155	37306
1	2	4-1/2	1	0.190	0.3500	38576	38621	38663	37149	37156	37307
1	2	4-1/2	1	0.250	0.3500	38577	38622	38664	37150	37157	37308

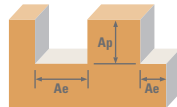

Series	Z5, Z5CR	Hardness	Ae x DC	Ap x DC	Vc (sfm)	DC • in								
						1/8	1/4	3/8	1/2	5/8	3/4	1		
P	CARBON STEELS 1018, 1040, 1080, 1090, 10L50, 1140, 1212, 12L15, 1525, 1536	≤ 275 Bhn or ≤ 28 HRc	Profile	≤ 0.5	≤ 1.5	555 (444-666)	RPM	16961	8480	5654	4240	3392	2827	2120
							Fz	0.00046	0.0012	0.0023	0.0031	0.0034	0.0037	0.0043
							Feed (ipm)	39.0	50.9	65.0	65.7	57.7	52.3	45.6
		≤ 275 Bhn or ≤ 28 HRc	Slot	1	≤ 1	440 (352-528)	RPM	13446	6723	4482	3362	2689	2241	1681
							Fz	0.00046	0.0012	0.0023	0.0031	0.0034	0.0037	0.0043
							Feed (ipm)	30.9	40.3	51.5	52.1	45.7	41.5	36.1
	ALLOY STEELS 4140, 4150, 4320, 5120, 5150, 8630, 86L20, 50100	≤ 375 Bhn or ≤ 40 HRc	Profile	≤ 0.5	≤ 1.5	315 (252-378)	RPM	9626	4813	3209	2407	1925	1604	1203
							Fz	0.00034	0.0009	0.0017	0.0023	0.0026	0.0028	0.0032
							Feed (ipm)	16.4	21.7	27.3	27.7	25.0	22.5	19.3
		≤ 375 Bhn or ≤ 40 HRc	Slot	1	≤ 1	250 (200-300)	RPM	7640	3820	2547	1910	1528	1273	955
							Fz	0.00034	0.0009	0.0017	0.0023	0.0026	0.0028	0.0032
							Feed (ipm)	13.0	17.2	21.6	22.0	19.9	17.8	15.3
K	CAST IRONS (LOW & MEDIUM ALLOY) Gray, Malleable, Ductile	≤ 220 Bhn or ≤ 19 HRc	Profile	≤ 0.5	≤ 1.5	445 (356-534)	RPM	13599	6800	4533	3400	2720	2267	1700
							Fz	0.00042	0.0011	0.0021	0.0028	0.0031	0.0034	0.0039
							Feed (ipm)	28.6	37.4	47.6	47.6	42.2	38.5	33.1
		≤ 220 Bhn or ≤ 19 HRc	Slot	1	≤ 1	355 (284-426)	RPM	10849	5424	3616	2712	2170	1808	1356
							Fz	0.00042	0.0011	0.0021	0.0028	0.0031	0.0034	0.0039
							Feed (ipm)	22.8	29.8	38.0	38.0	33.6	30.7	26.4
	CAST IRONS (HIGH ALLOY) Gray, Malleable, Ductile	≤ 260 Bhn or ≤ 26 HRc	Profile	≤ 0.5	≤ 1.5	340 (272-408)	RPM	10390	5195	3463	2598	2078	1732	1299
							Fz	0.00031	0.0008	0.0016	0.0021	0.0023	0.0025	0.0029
							Feed (ipm)	16.1	21.8	27.7	27.3	23.9	21.6	18.8
		≤ 260 Bhn or ≤ 26 HRc	Slot	1	≤ 1	270 (216-324)	RPM	8251	4126	2750	2063	1650	1375	1031
							Fz	0.00031	0.0008	0.0016	0.0021	0.0023	0.0025	0.0029
							Feed (ipm)	12.8	17.3	22.0	21.7	19.0	17.2	15.0
M	STAINLESS STEELS (FREE MACHINING) 303, 416, 420F, 430F, 440F	≤ 275 Bhn or ≤ 28 HRc	Profile	≤ 0.5	≤ 1.5	490 (392-588)	RPM	14974	7487	4991	3744	2995	2496	1872
							Fz	0.00034	0.0009	0.0017	0.0023	0.0026	0.0028	0.0032
							Feed (ipm)	25.5	33.7	42.4	43.1	38.9	34.9	29.9
		≤ 275 Bhn or ≤ 28 HRc	Slot	1	≤ 1	390 (312-468)	RPM	11918	5959	3973	2980	2384	1986	1490
							Fz	0.00034	0.0009	0.0017	0.0023	0.0026	0.0028	0.0032
							Feed (ipm)	20.3	26.8	33.8	34.3	31.0	27.8	23.8
	STAINLESS STEELS (DIFFICULT) 304, 304L, 316, 316L	≤ 275 Bhn or ≤ 28 HRc	Profile	≤ 0.5	≤ 1.5	340 (272-408)	RPM	10390	5195	3463	2598	2078	1732	1299
							Fz	0.00027	0.0007	0.0014	0.0018	0.0020	0.0022	0.0025
							Feed (ipm)	14.0	18.2	24.2	23.4	20.8	19.0	16.2
		≤ 275 Bhn or ≤ 28 HRc	Slot	1	≤ 1	270 (216-324)	RPM	8251	4126	2750	2063	1650	1375	1031
							Fz	0.00027	0.0007	0.0014	0.0018	0.0020	0.0022	0.0025
							Feed (ipm)	11.1	14.4	19.3	18.6	16.5	15.1	12.9
STAINLESS STEELS (PH) 13-8 PH, 15-5PH, 17-4 PH, CUSTOM 450	≤ 325 Bhn or ≤ 35 HRc	Profile	≤ 0.5	≤ 1.5	310 (248-372)	RPM	9474	4737	3158	2368	1895	1579	1184	
						Fz	0.00027	0.0007	0.0014	0.0018	0.0020	0.0022	0.0025	
						Feed (ipm)	12.8	16.6	22.1	21.3	18.9	17.4	14.8	
	≤ 325 Bhn or ≤ 35 HRc	Slot	1	≤ 1	250 (200-300)	RPM	7640	3820	2547	1910	1528	1273	955	
						Fz	0.00027	0.0007	0.0014	0.0018	0.0020	0.0022	0.0025	
						Feed (ipm)	10.3	13.4	17.8	17.2	15.3	14.0	11.9	

continued on next page

FRACTIONAL Z-Carb-HPR

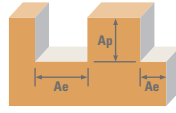

Series Z5, Z5CR Fractional	Hardness	Profile Ae x DC	Ap x DC	Vc (sfm)	DC • in								
					1/8	1/4	3/8	1/2	5/8	3/4	1		
S	SUPER ALLOYS (NICKEL, COBALT, IRON BASE) Inconel 601, 617, 625, Incoloy, Monel 400	Profile Ae x DC	≤ 0.5	≤ 1.5	80 (64-96)	RPM	2445	1222	815	611	489	407	306
						Fz	0.00025	0.00068	0.00128	0.00170	0.00187	0.00204	0.00238
						Feed (ipm)	3.1	4.2	5.2	5.2	4.6	4.2	3.6
		Slot Ae x DC	1	≤ 1	65 (52-78)	RPM	1986	993	662	497	397	331	248
						Fz	0.00025	0.00068	0.00128	0.00170	0.00187	0.00204	0.00238
						Feed (ipm)	2.5	3.4	4.2	4.2	3.7	3.4	3.0
	SUPER ALLOYS (NICKEL, COBALT, IRON BASE) Inconel 718, X-750, Incoloy, Waspaloy, Hastelloy, Rene	Profile Ae x DC	≤ 0.5	≤ 1.5	62 (50-74)	RPM	1895	947	632	474	379	316	237
						Fz	0.00018	0.00048	0.00090	0.00120	0.00130	0.00140	0.00170
						Feed (ipm)	1.7	2.3	2.8	2.8	2.5	2.2	2.0
		Slot Ae x DC	1	≤ 1	50 (40-60)	RPM	1528	764	509	382	306	255	191
						Fz	0.00018	0.00048	0.00090	0.00120	0.00130	0.00140	0.00170
						Feed (ipm)	1.4	1.8	2.3	2.3	2.0	1.8	1.6
TITANIUM ALLOYS Pure Titanium, Ti6Al4V, Ti6Al2Sn4Zr2Mo, Ti4Al4Mo2Sn0.5Si	Profile Ae x DC	≤ 0.5	≤ 1.5	215 (172-258)	RPM	6570	3285	2190	1643	1314	1095	821	
					Fz	0.0003	0.0008	0.0015	0.0020	0.0022	0.0024	0.0028	
					Feed (ipm)	9.9	13.1	16.4	16.4	14.5	13.1	11.5	
	Slot Ae x DC	1	≤ 1	170 (136-204)	RPM	5195	2598	1732	1299	1039	866	649	
					Fz	0.0003	0.0008	0.0015	0.0020	0.0022	0.0024	0.0028	
					Feed (ipm)	7.8	10.4	13.0	13.0	11.4	10.4	9.1	
TITANIUM ALLOYS (DIFFICULT) Ti10Al2Fe3Al, Ti5Al5V5Mo3Cr, Ti7Al4Mo, Ti3Al8V6Cr4Zr4Mo, Ti6Al6V6Sn, Ti15V3 Cr3Sn3Al	Profile Ae x DC	≤ 0.5	≤ 1.5	75 (60-90)	RPM	2292	1146	764	573	458	382	287	
					Fz	0.0003	0.0008	0.0015	0.0020	0.0022	0.0024	0.0028	
					Feed (ipm)	3.4	4.6	5.7	5.7	5.0	4.6	4.0	
	Slot Ae x DC	1	≤ 1	60 (48-72)	RPM	1834	917	611	458	367	306	229	
					Fz	0.0003	0.0008	0.0015	0.0020	0.0022	0.0024	0.0028	
					Feed (ipm)	2.8	3.7	4.6	4.6	4.0	3.7	3.2	
H TOOL STEELS A2, D2, H13, L2, M2, P20, S7, T15, W2	Profile Ae x DC	≤ 0.5	≤ 1.5	185 (148-222)	RPM	5654	2827	1885	1413	1131	942	707	
					Fz	0.00028	0.0007	0.0014	0.0018	0.0020	0.0022	0.0026	
					Feed (ipm)	7.9	9.9	13.2	12.7	11.3	10.4	9.2	
	Slot Ae x DC	1	≤ 1	145 (116-174)	RPM	4431	2216	1477	1108	886	739	554	
					Fz	0.00028	0.0007	0.0014	0.0018	0.0020	0.0022	0.0026	
					Feed (ipm)	6.2	7.8	10.3	10.0	8.9	8.1	7.2	

Bhn (Brinell) HRC (Rockwell C)

rpm = Vc x 3.82 / DC

ipm = Fz x 5 x rpm

ramp up to 5 degrees using slotting speed and feed rates. Do not plunge.

reduce speed and feed for materials harder than listed

reduce feed and Ae when finish milling (.02 x DC maximum)

feed rates listed have chip thinning adjustments included where applicable

refer to the SGS Tool Wizard® for complete technical information (www.kyocera-sgstool.com)

TOLERANCES (mm)

6 DIAMETER

DC = +0,000/-0,030

DCON = h₆

RE = +0,000/-0,050

>6-10 DIAMETER

DC = +0,000/-0,040

DCON = h₆

RE = +0,000/-0,050

>10-25 DIAMETER

DC = +0,000/-0,050

DCON = h₆

RE = +0,000/-0,050

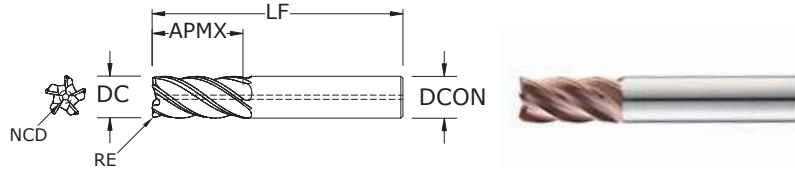
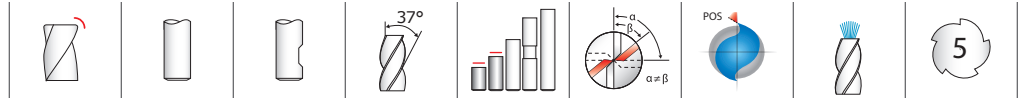

Z5MCR
METRIC SERIES

mm						EDP NO.					
CUTTING DIAMETER DC	LENGTH OF CUT APMX	OVERALL LENGTH LF	SHANK DIAMETER DCON	CORNER RADIUS RE	NON-CUTTING CENTER DIAMETER NCD	TI-NAMITE-A (TA)	TI-NAMITE-A (TA) W/FLAT	TI-NAMITE-A (TA) W/INTERNAL COOLANT	TI-NAMITE-M (TM)	TI-NAMITE-M (TM) W/FLAT	TI-NAMITE-M (TM) W/INTERNAL COOLANT
6,0	9,0	54,0	6,0	0,5	2,11	48000	-	-	47000	-	-
6,0	13,0	57,0	6,0	0,3	2,11	48001	-	-	47001	-	-
6,0	13,0	57,0	6,0	0,5	2,11	47120	-	-	47002	-	-
6,0	13,0	57,0	6,0	1,0	2,11	48002	-	-	47003	-	-
6,0	13,0	57,0	6,0	1,5	2,11	48003	-	-	47004	-	-
8,0	11,0	58,0	8,0	0,5	2,79	48004	-	-	47005	-	-
8,0	18,0	63,0	8,0	0,5	2,79	47121	-	-	47006	-	-
8,0	18,0	63,0	8,0	1,0	2,79	47122	-	-	47007	-	-
8,0	18,0	63,0	8,0	1,5	2,79	48005	-	-	47008	-	-
8,0	18,0	63,0	8,0	2,0	2,79	48006	-	-	47009	-	-
10,0	13,0	66,0	10,0	1,0	2,79	48007	-	-	47010	-	-
10,0	22,0	72,0	10,0	0,5	3,51	47123	-	-	47011	-	-
10,0	22,0	72,0	10,0	1,0	3,51	47124	-	-	47012	-	-
10,0	22,0	72,0	10,0	1,5	3,51	48008	-	-	47013	-	-
10,0	22,0	72,0	10,0	2,0	3,51	48009	-	-	47014	-	-
10,0	22,0	72,0	10,0	2,5	3,51	48010	-	-	47015	-	-
12,0	15,0	73,0	12,0	1,0	4,19	48011	48029	-	47016	47024	-
12,0	26,0	83,0	12,0	0,5	4,19	47125	47128	47160	47017	47025	47161
12,0	26,0	83,0	12,0	0,76	4,19	47126	47129	47162	47018	47026	47163
12,0	26,0	83,0	12,0	1,0	4,19	47127	47130	47164	47019	47027	47165
12,0	26,0	83,0	12,0	1,5	4,19	48012	48030	47166	47020	47028	47167
12,0	26,0	83,0	12,0	2,0	4,19	48013	48031	47168	47021	47029	47169
12,0	26,0	83,0	12,0	2,5	4,19	48014	48032	47170	47022	47030	47171
12,0	26,0	83,0	12,0	3,0	4,19	48015	48033	47172	47023	47031	47173
16,0	19,0	82,0	16,0	1,0	5,59	48016	48034	48056	47032	47039	47046
16,0	19,0	82,0	16,0	1,5	5,59	48070	-	-	48071	-	-
16,0	35,0	92,0	16,0	1,0	5,59	47131	48035	47134	47033	47040	47047
16,0	35,0	92,0	16,0	1,5	5,59	48017	48036	48057	47034	47041	47048

- An ideal balance of helix, indexing, flute depth, rake and relief
- Variable indexing for chatter suppression and patented edge geometry for shearing and strength
- Chatter-free geometry allows deep cutting and high speed machining
- Central coolant hole delivers coolant effectively to the cutting zone enhancing chip removal when pocketing or slotting
- Enhanced corner geometry with tight tolerance corner radii
- Excels at roughing, ramping, high speed machining and finishing in a variety of materials
- Recommended for materials ≤ 45 HRC (≤ 420 Bhn)

- STEELS
- STAINLESS STEELS
- CAST IRON
- HIGH TEMP ALLOYS
- TITANIUM
- HARDENED STEELS

For patent information visit www.ksptpatents.com

continued on next page

METRIC Z-Carb-HPR

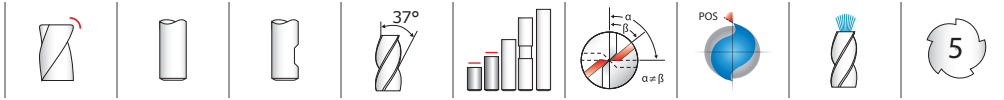

TOLERANCES (mm)

6 DIAMETER
DC = +0,000/-0,030
DCON = h_6
RE = +0,000/-0,050
>6-10 DIAMETER
DC = +0,000/-0,040
DCON = h_6
RE = +0,000/-0,050
>10-25 DIAMETER
DC = +0,000/-0,050
DCON = h_6
RE = +0,000/-0,050

Z5MCR METRIC SERIES

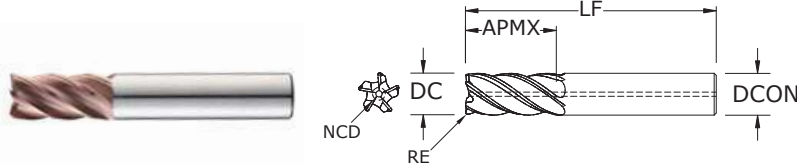

CONTINUED

- An ideal balance of helix, indexing, flute depth, rake and relief
- Variable indexing for chatter suppression and patented edge geometry for shearing and strength
- Chatter-free geometry allows deep cutting and high speed machining
- Central coolant hole delivers coolant effectively to the cutting zone enhancing chip removal when pocketing or slotting
- Enhanced corner geometry with tight tolerance corner radii
- Excels at roughing, ramping, high speed machining and finishing in a variety of materials
- Recommended for materials ≤ 45 HRC (≤ 420 Bhn)

- STEELS
- STAINLESS STEELS
- CAST IRON
- HIGH TEMP ALLOYS
- TITANIUM
- HARDENED STEELS

For patent information visit www.ksptpatents.com

mm						EDP NO.					
CUTTING DIAMETER DC	LENGTH OF CUT APMX	OVERALL LENGTH LF	SHANK DIAMETER DCON	CORNER RADIUS RE	NON-CUTTING CENTER DIAMETER NCD	TI-NAMITE-A (TA) W/INTERNAL COOLANT	TI-NAMITE-A (TA) W/FLAT	TI-NAMITE-A (TA) W/INTERNAL COOLANT	TI-NAMITE-M (TM)	TI-NAMITE-M (TM) W/FLAT	TI-NAMITE-M (TM) W/INTERNAL COOLANT
16,0	35,0	92,0	16,0	2,0	5,59	47132	48037	47135	47035	47042	47049
16,0	35,0	92,0	16,0	2,5	5,59	48018	48038	48058	47036	47043	47050
16,0	35,0	92,0	16,0	3,0	5,59	47133	48039	47136	47037	47044	47051
16,0	35,0	92,0	16,0	4,0	5,59	48019	48040	48059	47038	47045	47052
20,0	23,0	92,0	20,0	1,0	7,01	48020	48041	48060	47053	47061	47069
20,0	43,0	104,0	20,0	1,0	7,01	47137	48042	47140	47054	47062	47070
20,0	43,0	104,0	20,0	1,5	7,01	48021	48043	48061	47055	47063	47071
20,0	43,0	104,0	20,0	2,0	7,01	47138	48044	47141	47056	47064	47072
20,0	43,0	104,0	20,0	2,5	7,01	48022	48045	48062	47057	47065	47073
20,0	43,0	104,0	20,0	3,0	7,01	47139	48046	47142	47058	47066	47074
20,0	43,0	104,0	20,0	4,0	7,01	48023	48047	48063	47059	47067	47075
20,0	43,0	104,0	20,0	5,0	7,01	48024	48048	48064	47060	47068	47076
25,0	28,0	100,0	25,0	1,0	8,76	48025	48049	48065	47077	47084	47091
25,0	53,0	121,0	25,0	1,0	8,76	47143	48050	47146	47078	47085	47092
25,0	53,0	121,0	25,0	2,0	8,76	47144	48051	47147	47079	47086	47093
25,0	53,0	121,0	25,0	2,5	8,76	48026	48052	48066	47080	47087	47094
25,0	53,0	121,0	25,0	3,0	8,76	47145	48053	47148	47081	47088	47095
25,0	53,0	121,0	25,0	4,0	8,76	48027	48054	48067	47082	47089	47096
25,0	53,0	121,0	25,0	5,0	8,76	48028	48055	48068	47083	47090	47097

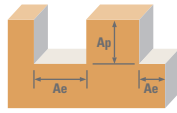

Series Z5MCR Metric	Hardness	Profile Ae x DC	Slot Ap x DC	Vc (m/min)	DC • mm							
					6	8	10	12	16	20	25	
P	CARBON STEELS 1018, 1040, 1080, 1090, 10L50, 1140, 1212, 12L15, 1525, 1536 ≤ 275 Bhn or ≤ 28 HRc	Profile Ae x DC	Ap x DC	169 (135-203)	RPM	8967	6725	5380	4484	3363	2690	2152
					Fz	0.029	0.049	0.061	0.074	0.087	0.099	0.108
					Feed (mm/min)	1291	1650	1650	1668	1463	1327	1157
		Slot Ae x DC	Ap x DC	134 (107-161)	RPM	7109	5332	4265	3555	2666	2133	1706
					Fz	0.029	0.049	0.061	0.074	0.087	0.099	0.108
					Feed (mm/min)	1024	1308	1308	1322	1160	1052	917
K	ALLOY STEELS 4140, 4150, 4320, 5120, 5150, 8630, 86L20, 50100 ≤ 375 Bhn or ≤ 40 HRc	Profile Ae x DC	Ap x DC	96 (77-115)	RPM	5089	3817	3054	2545	1909	1527	1221
					Fz	0.022	0.036	0.045	0.055	0.067	0.075	0.080
					Feed (mm/min)	550	692	692	702	635	570	489
		Slot Ae x DC	Ap x DC	76 (61-91)	RPM	4039	3029	2424	2020	1515	1212	969
					Fz	0.022	0.036	0.045	0.055	0.067	0.075	0.080
					Feed (mm/min)	436	549	549	557	504	452	388
M	CAST IRONS (LOW & MEDIUM ALLOY) Gray, Malleable, Ductile ≤ 220 Bhn or ≤ 19 HRc	Profile Ae x DC	Ap x DC	136 (109-163)	RPM	7190	5392	4314	3595	2696	2157	1726
					Fz	0.026	0.045	0.056	0.067	0.079	0.091	0.098
					Feed (mm/min)	949	1208	1208	1208	1070	978	841
		Slot Ae x DC	Ap x DC	108 (87-130)	RPM	5736	4302	3441	2868	2151	1721	1377
					Fz	0.026	0.045	0.056	0.067	0.079	0.091	0.098
					Feed (mm/min)	757	964	964	964	853	780	671
M	CAST IRONS (HIGH ALLOY) Gray, Malleable, Ductile ≤ 260 Bhn or ≤ 26 HRc	Profile Ae x DC	Ap x DC	104 (83-124)	RPM	5493	4120	3296	2747	2060	1648	1318
					Fz	0.020	0.034	0.043	0.050	0.059	0.067	0.073
					Feed (mm/min)	554	703	703	692	606	549	478
		Slot Ae x DC	Ap x DC	82 (66-99)	RPM	4362	3272	2617	2181	1636	1309	1047
					Fz	0.020	0.034	0.043	0.050	0.059	0.067	0.073
					Feed (mm/min)	440	558	558	550	482	436	380
M	STAINLESS STEELS (FREE MACHINING) 303, 416, 420F, 430F, 440F ≤ 275 Bhn or ≤ 28 HRc	Profile Ae x DC	Ap x DC	149 (119-179)	RPM	7917	5938	4750	3958	2969	2375	1900
					Fz	0.022	0.036	0.045	0.055	0.067	0.075	0.080
					Feed (mm/min)	855	1077	1077	1092	988	887	760
		Slot Ae x DC	Ap x DC	119 (95-143)	RPM	6301	4726	3781	3151	2363	1890	1512
					Fz	0.022	0.036	0.045	0.055	0.067	0.075	0.080
					Feed (mm/min)	680	857	857	869	786	706	605
M	STAINLESS STEELS (DIFFICULT) 304, 304L, 316, 316L ≤ 275 Bhn or ≤ 28 HRc	Profile Ae x DC	Ap x DC	104 (83-124)	RPM	5493	4120	3296	2747	2060	1648	1318
					Fz	0.017	0.030	0.037	0.043	0.051	0.059	0.063
					Feed (mm/min)	461	615	615	593	527	483	412
		Slot Ae x DC	Ap x DC	82 (66-99)	RPM	4362	3272	2617	2181	1636	1309	1047
					Fz	0.017	0.030	0.037	0.043	0.051	0.059	0.063
					Feed (mm/min)	366	489	489	471	419	384	327
M	STAINLESS STEELS (PH) 13-8 PH, 15-5PH, 17-4 PH, CUSTOM 450 ≤ 325 Bhn or ≤ 35 HRc	Profile Ae x DC	Ap x DC	94 (76-113)	RPM	5009	3756	3005	2504	1878	1503	1202
					Fz	0.017	0.030	0.037	0.043	0.051	0.059	0.063
					Feed (mm/min)	421	561	561	541	481	441	376
		Slot Ae x DC	Ap x DC	76 (61-91)	RPM	4039	3029	2424	2020	1515	1212	969
					Fz	0.017	0.030	0.037	0.043	0.051	0.059	0.063
					Feed (mm/min)	339	452	452	436	388	355	303

continued on next page

Z-Carb-HPR

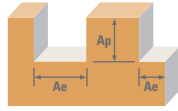

Series Z5MCR	Metric	Hardness	Ae x DC	Ap x DC	Vc (m/min)	DC • mm								
						6	8	10	12	16	20	25		
S	SUPER ALLOYS (NICKEL, COBALT, IRON BASE) Inconel 601, 617, 625, Incoloy, Monel 400	≤ 300 Bhn or ≤ 32 HRc	Profile 	≤ 0.5	≤ 1.5	24 (20-29)	RPM	1293	969	776	646	485	388	310
							Fz	0.0160	0.0272	0.0340	0.0409	0.0478	0.0531	0.0599
							Feed (mm/min)	103	132	132	132	116	103	93
			Slot 	1	≤ 1	20 (16-24)	RPM	1050	788	630	525	394	315	252
							Fz	0.0160	0.0272	0.0340	0.0409	0.0478	0.0531	0.0599
							Feed (mm/min)	84	107	107	107	94	84	75
	SUPER ALLOYS (NICKEL, COBALT, IRON BASE) Inconel 718, X-750, Incoloy, Waspaloy, Hastelloy, Rene	≤ 400 Bhn or ≤ 43 HRc	Profile 	≤ 0.5	≤ 1.5	19 (15-23)	RPM	1002	751	601	501	376	301	240
							Fz	0.0112	0.0192	0.0239	0.0284	0.0333	0.0371	0.0420
							Feed (mm/min)	56	72	72	71	63	56	50
			Slot 	1	≤ 1	15 (12-18)	RPM	808	606	485	404	303	242	194
							Fz	0.0112	0.0192	0.0239	0.0284	0.0333	0.0371	0.0420
							Feed (mm/min)	45	58	58	57	50	45	41
TITANIUM ALLOYS Pure Titanium, Ti6Al4V, Ti6Al2Sn4Zr2Mo, Ti4Al4Mo2Sn0.5Si	≤ 350 Bhn or ≤ 38 HRc	Profile 	≤ 0.5	≤ 1.5	66 (52-79)	RPM	3474	2605	2084	1737	1303	1042	834	
						Fz	0.019	0.032	0.040	0.048	0.056	0.064	0.070	
						Feed (mm/min)	333	417	417	417	367	333	292	
		Slot 	1	≤ 1	52 (41-62)	RPM	2747	2060	1648	1373	1030	824	659	
						Fz	0.019	0.032	0.040	0.048	0.056	0.064	0.070	
						Feed (mm/min)	264	330	330	330	290	264	231	
TITANIUM ALLOYS (DIFFICULT) Ti10Al2Fe3Al, Ti5Al5V5Mo3Cr, Ti7Al4Mo, Ti3Al8V6Cr4Zr4Mo, Ti6Al6V6Sn, Ti15V3 Cr3Sn3Al	≤ 440 Bhn or ≤ 47 HRc	Profile 	≤ 0.5	≤ 1.5	23 (18-27)	RPM	1212	909	727	606	454	364	291	
						Fz	0.019	0.032	0.040	0.048	0.056	0.064	0.071	
						Feed (mm/min)	116	145	145	145	128	116	103	
		Slot 	1	≤ 1	18 (15-22)	RPM	969	727	582	485	364	291	233	
						Fz	0.019	0.032	0.040	0.048	0.056	0.064	0.071	
						Feed (mm/min)	93	116	116	116	102	93	83	
H	TOOL STEELS A2, D2, H13, L2, M2, P20, S7, T15, W2	≤ 375 Bhn or ≤ 40 HRc	Profile 	≤ 0.5	≤ 1.5	56 (45-68)	RPM	2989	2242	1793	1495	1121	897	717
							Fz	0.017	0.030	0.037	0.043	0.051	0.059	0.065
							Feed (mm/min)	251	335	335	323	287	263	233
			Slot 	1	≤ 1	44 (35-53)	RPM	2343	1757	1406	1171	879	703	562
							Fz	0.017	0.030	0.037	0.043	0.051	0.059	0.065
							Feed (mm/min)	197	262	262	253	225	206	183

Bhn (Brinell) HRc (Rockwell C)
 rpm = (Vc x 1000) / (DC x 3.14)
 mm/min = Fz x 5 x rpm
 ramp up to 5 degrees using slotting speed and feed rates. Do not plunge.
 reduce speed and feed for materials harder than listed
 reduce feed and Ae when finish milling (.02 x DC maximum)
 feed rates listed have chip thinning adjustments included where applicable
 refer to the SGS Tool Wizard® for complete technical information (www.kyocera-sgstool.com)

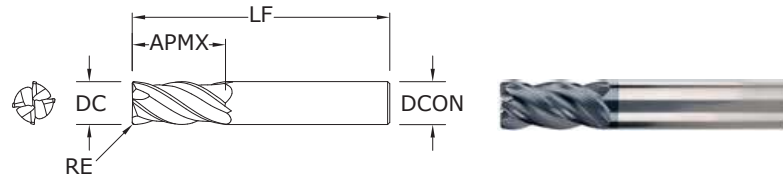
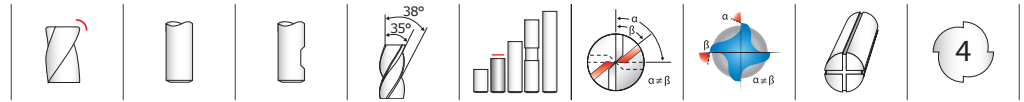

Z1PCR FRACTIONAL SERIES

TOLERANCES (inch)

<1/8 DIAMETER

DC = +0.0005/-0.0005

DCON = h_6

RE = +0.000/-0.0010

1/8-1/4 DIAMETER

DC = +0.000/-0.0012

DCON = h_6

RE = +0.000/-0.0020

>1/4-3/8 DIAMETER

DC = +0.000/-0.0016

DCON = h_6

RE = +0.000/-0.0020

>3/8-1 DIAMETER

DC = +0.000/-0.0020

DCON = h_6

RE = +0.000/-0.0020

STEELS

STAINLESS STEELS

CAST IRON

HIGH TEMP ALLOYS

TITANIUM

HARDENED STEELS

For patent information visit www.ksptpatents.com

CUTTING DIAMETER DC	LENGTH OF CUT APMX	inch			CORNER RADIUS RE	EDP NO.		
		OVERALL LENGTH LF	SHANK DIAMETER DCON			Ti-NAMITE-X	Ti-NAMITE-X W/FLAT	JetStream
1/64	1/32	1-1/2	1/8	.002	36874*	-	-	
1/32	5/64	1-1/2	1/8	.005	36875*	-	-	
3/64	7/64	1-1/2	1/8	.005	36876*	-	-	
1/16	3/16	1-1/2	1/8	.005	36872*	-	-	
5/64	3/16	1-1/2	1/8	.005	36877*	-	-	
3/32	9/32	1-1/2	1/8	.010	36873*	-	-	
7/64	3/8	1-1/2	1/8	.010	36878*	-	-	
1/8	3/8	1-1/2	1/8	.010	36370	-	-	
1/8	3/8	1-1/2	1/8	.015	36851	-	-	
3/16	7/16	2	3/16	.010	36371	-	-	
3/16	7/16	2	3/16	.015	36852	-	-	
3/16	7/16	2	3/16	.030	36722	-	-	
1/4	1/2	2-1/2	1/4	.010	36372	-	-	
1/4	1/2	2-1/2	1/4	.015	36723	-	-	
1/4	1/2	2-1/2	1/4	.020	36853	-	-	
1/4	1/2	2-1/2	1/4	.030	36373	-	-	
1/4	3/4	2-1/2	1/4	.010	36599	-	-	
1/4	3/4	2-1/2	1/4	.015	36600	-	-	
1/4	3/4	2-1/2	1/4	.020	36854	-	-	
1/4	3/4	2-1/2	1/4	.030	36601	-	-	
5/16	13/16	2-1/2	5/16	.015	36724	-	-	
5/16	13/16	2-1/2	5/16	.020	36855	-	-	
5/16	13/16	2-1/2	5/16	.030	36374	-	-	
3/8	7/8	2-1/2	3/8	.010	36375	36701	-	
3/8	7/8	2-1/2	3/8	.015	36725	36736	-	
3/8	7/8	2-1/2	3/8	.020	36856	36864	-	
3/8	7/8	2-1/2	3/8	.030	36376	36702	-	
3/8	7/8	2-1/2	3/8	.060	36727	36738	-	
7/16	1	2-3/4	7/16	.020	36857	36865	-	
1/2	1	3	1/2	.010	36378	36704	36804	
1/2	1	3	1/2	.015	36729	36740	36810	
1/2	1	3	1/2	.030	36858	36866	36805	
1/2	1	3	1/2	.060	36380	36706	36811	
1/2	1	3	1/2	.090	36381	36707	36812	

*Variable flute spacing. Helix and rake do not vary.

continued on next page

- Variable rake geometry alters and controls the cutting dynamic taking chatter suppression to an unprecedented level
- Unequal helix design changes the cutting angle to improve harmonics
- Unequal flute spacing helps to disrupt the rhythmic pattern created by the cutting edge helping to suppress damaging harmonics
- Enhanced corner geometry with tight tolerance corner radii
- Recommended for materials ≤ 45 HRC (≤ 420 Bhn)

FRACTIONAL Z-Carb-AP

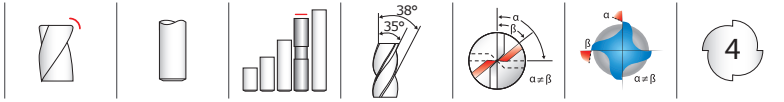

Z1PCR FRACTIONAL SERIES

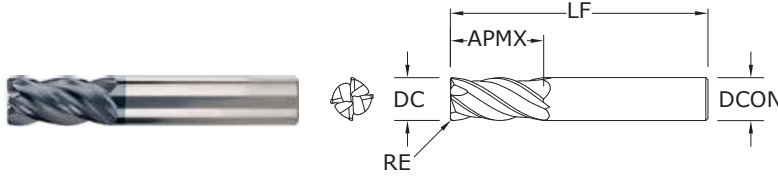

CONTINUED

CUTTING DIAMETER DC	LENGTH OF CUT APMX	inch			EDP NO.		
		OVERALL LENGTH LF	SHANK DIAMETER DCON	CORNER RADIUS RE	Ti-NAMITE-X	Ti-NAMITE-X W/FLAT	JetStream
1/2	1	3	1/2	.125	36731	36742	36813
1/2	1-1/4	3-1/4	1/2	.010	36602	36603	—
1/2	1-1/4	3-1/4	1/2	.015	36604	36605	—
1/2	1-1/4	3-1/4	1/2	.030	36859	36867	—
1/2	1-1/4	3-1/4	1/2	.060	36610	36611	—
1/2	1-1/4	3-1/4	1/2	.090	36612	36613	—
1/2	1-1/4	3-1/4	1/2	.125	36614	36615	—
9/16	1-1/8	3-1/2	9/16	.030	36860	36868	36806
5/8	1-1/4	3-1/2	5/8	.030	36383	36709	36814
5/8	1-1/4	3-1/2	5/8	.040	36861	36869	36807
5/8	1-1/4	3-1/2	5/8	.060	36384	36710	36815
5/8	1-1/4	3-1/2	5/8	.090	36385	36711	36816
5/8	1-1/4	3-1/2	5/8	.125	36733	36744	36817
3/4	1-1/2	4	3/4	.030	36386	36712	36818
3/4	1-1/2	4	3/4	.040	36862	36870	36808
3/4	1-1/2	4	3/4	.060	36387	36713	36819
3/4	1-1/2	4	3/4	.090	36388	36714	36820
3/4	1-1/2	4	3/4	.125	36389	36715	36821
1	1-1/2	4	1	.030	36390	36716	36822
1	1-1/2	4	1	.040	36863	36871	36809
1	1-1/2	4	1	.060	36391	36717	36823
1	1-1/2	4	1	.090	36392	36718	36824
1	1-1/2	4	1	.125	36393	36719	36825

TOLERANCES (inch)

<1/8 DIAMETER

DC = +0.0005/-0.0005

DCON = h₆

RE = +0.000/-0.0010

1/8-1/4 DIAMETER

DC = +0.000/-0.0012

DCON = h₆

RE = +0.000/-0.0020

>1/4-3/8 DIAMETER

DC = +0.000/-0.0016

DCON = h₆

RE = +0.000/-0.0020

>3/8-1 DIAMETER

DC = +0.000/-0.0020

DCON = h₆

RE = +0.000/-0.0020

STEELS

STAINLESS STEELS

CAST IRON

HIGH TEMP ALLOYS

TITANIUM

HARDENED STEELS

For patent information visit
www.ksptpatents.com

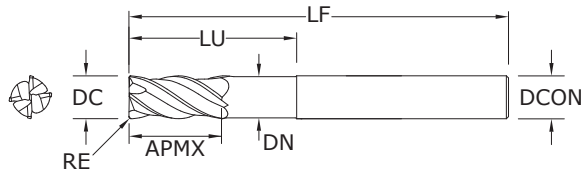
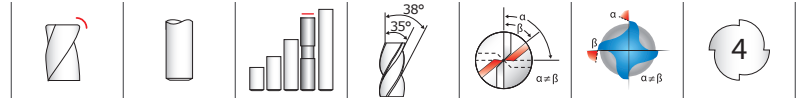

Z1PLC
FRACTIONAL SERIES

TOLERANCES (inch)

1/4 DIAMETER

DC = +0.0000/-0.0012

DCON = h_6

RE = +0.000/-0.005

>1/4-3/8 DIAMETER

DC = +0.0000/-0.0016

DCON = h_6

RE = +0.000/-0.005

>3/8-1 DIAMETER

DC = +0.0000/-0.0020

DCON = h_6

RE = +0.000/-0.005

STEELS

STAINLESS STEELS

CAST IRON

HIGH TEMP ALLOYS

TITANIUM

HARDENED STEELS

For patent information visit www.ksptpatents.com

CUTTING DIAMETER DC	LENGTH OF CUT APMX	OVERALL LENGTH LF	inch					CORNER RADIUS RE	EDP NO. Ti-NAMITE-X
			SHANK DIAMETER DCON	REACH LU	NECK DIAMETER DN				
1/4	1/2	2-1/2	1/4	1-1/8	.230	.020	36447		
1/4	1/2	3-1/2	1/4	1-5/8	.230	.020	36448		
1/4	1/2	4	1/4	1-1/4	.230	.020	36450		
1/4	1/2	4	1/4	2-1/8	.230	.020	36449		
5/16	13/16	3	5/16	1-3/8	.293	.020	36453		
5/16	13/16	4	5/16	2	.293	.020	36454		
5/16	13/16	4	5/16	1-5/8	.293	.020	36452		
3/8	7/8	3	3/8	1-5/8	.355	.020	36457		
3/8	7/8	5	3/8	1-7/8	.355	.020	36456		
3/8	7/8	4	3/8	2-3/8	.355	.020	36458		
7/16	1	6	7/16	2	.418	.020	36460		
1/2	1	4	1/2	2	.480	.030	36463		
1/2	1	5	1/2	3	.480	.030	36464		
1/2	1	6	1/2	2-1/4	.480	.030	36462		
9/16	1-1/8	6	9/16	2-1/2	.543	.030	36466		
5/8	1-1/4	5	5/8	2-1/2	.605	.040	36468		
5/8	1-1/4	6	5/8	3-3/4	.605	.040	36469		
5/8	1-1/4	6	5/8	3	.605	.040	36470		
3/4	1-1/2	6	3/4	3-1/2	.730	.040	36472		
1	1-1/2	6	1	3	.980	.040	36475		
1	1-1/2	6	1	4	.980	.040	36474		

- Variable rake geometry alters and controls the cutting dynamic taking chatter suppression to an unprecedented level
- Unequal helix design changes the cutting angle to improve harmonics
- Unequal flute spacing helps to disrupt the rhythmic pattern created by the cutting edge helping to suppress damaging harmonics
- Long reach design allows for deeper and faster cuts
- Enhanced corner geometry with tight tolerance corner radii
- Recommended for materials ≤ 45 HRc (≤ 420 Bhn)

FRACTIONAL Z-Carb-AP

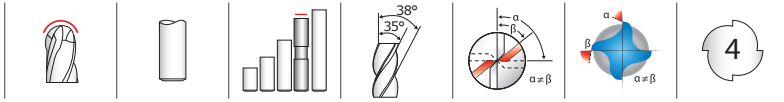

Z1PLB FRACTIONAL SERIES

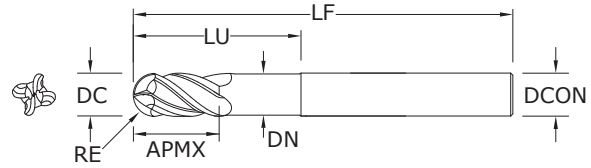

- Variable rake geometry alters and controls the cutting dynamic taking chatter suppression to an unprecedented level
- Unequal helix design changes the cutting angle to improve harmonics
- Long reach design allows for deeper and faster cuts
- Ball nose design ideal for finishing operations in complex workpieces
- Recommended for materials ≤ 45 HRc (≤ 420 Bhn)

CUTTING DIAMETER DC	LENGTH OF CUT APMX	inch				NECK DIAMETER DN	EDP NO. Ti-NAMITE-X
		OVERALL LENGTH LF	SHANK DIAMETER DCON	REACH LU			
1/4	1/2	4	1/4	1-1/4	.230	36480	
5/16	13/16	4	5/16	1-5/8	.293	36482	
3/8	7/8	5	3/8	1-7/8	.355	36486	
7/16	1	6	7/16	2	.418	38490	
1/2	1	6	1/2	2-1/4	.480	38492	
9/16	1-1/8	6	9/16	2-1/2	.543	38496	
5/8	1-1/4	6	5/8	3	.605	36500	
3/4	1-1/2	6	3/4	3-1/2	.730	36502	
1	1-1/2	6	1	4	.980	36504	

RE = 1/2 Cutting Diameter (DC)

TOLERANCES (inch)

1/4 DIAMETER

DC = +0.0000/-0.0012

DCON = h_6

RE = +0.0000/-0.0006

>1/4-3/8 DIAMETER

DC = +0.0000/-0.0016

DCON = h_6

RE = +0.0000/-0.0008

>3/8-1 DIAMETER

DC = +0.0000/-0.0020

DCON = h_6

RE = +0.0000/-0.0010

- STEELS
- STAINLESS STEELS
- CAST IRON
- HIGH TEMP ALLOYS
- TITANIUM
- HARDENED STEELS

For patent information visit www.ksptpatents.com

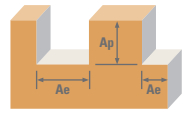

Series
Z1, Z16CR, Z1PCR,
Z1PLC, Z1PLB
Fractional

Series	Hardness	Ae x DC	Ap x DC	Vc (sfm)	DC • in										
					1/64	1/8	1/4	3/8	1/2	5/8	3/4	1			
P CARBON STEELS 1018, 1040, 1080, 1090, 10L50, 1140, 1212, 12L15, 1525, 1536	≤ 275 Bhn or ≤ 28 HRc	Profile 	≤ 0.5	≤ 1.5	555	RPM	135904	16961	8480	5654	4240	3392	2827	2120	
					(444-666)	Fz	0.00005	0.00046	0.0012	0.0023	0.0031	0.0034	0.0037	0.0043	
						Feed (ipm)	27.2	31.2	40.7	52.0	52.6	46.1	41.8	36.5	
		Slot 	1	≤ 1	440	RPM	107744	13446	6723	4482	3362	2689	2241	1681	
					(352-528)	Fz	0.00005	0.00046	0.0012	0.0023	0.0031	0.0034	0.0037	0.0043	
						Feed (ipm)	21.5	24.7	32.3	41.2	41.7	36.6	33.2	28.9	
	ALLOY STEELS 4140, 4150, 4320, 5120, 5150, 8630, 86L20, 50100	≤ 375 Bhn or ≤ 40 HRc	Profile 	≤ 0.5	≤ 1.5	315	RPM	77135	9626	4813	3209	2407	1925	1604	1203
						(252-378)	Fz	0.00004	0.00034	0.0009	0.0017	0.0023	0.0026	0.0028	0.0032
							Feed (ipm)	12.3	13.1	17.3	21.8	22.1	20.0	18.0	15.4
			Slot 	1	≤ 1	250	RPM	61218	7640	3820	2547	1910	1528	1273	955
						(200-300)	Fz	0.00004	0.00034	0.0009	0.0017	0.0023	0.0026	0.0028	0.0032
							Feed (ipm)	9.8	10.4	13.8	17.3	17.6	15.9	14.3	12.2
M STAINLESS STEELS (FREE MACHINING) 303, 416, 420F, 430F, 440F		≤ 275 Bhn or ≤ 28 HRc	Profile 	≤ 0.5	≤ 1.5	490	RPM	119987	14974	7487	4991	3744	2995	2496	1872
						(392-588)	Fz	0.00004	0.00034	0.0009	0.0017	0.0023	0.0026	0.0028	0.0032
							Feed (ipm)	19.2	20.4	27.0	33.9	34.4	31.1	28.0	24.0
			Slot 	1	≤ 1	390	RPM	95500	11918	5959	3973	2980	2384	1986	1490
						(312-468)	Fz	0.00004	0.00034	0.0009	0.0017	0.0023	0.0026	0.0028	0.0032
							Feed (ipm)	15.3	16.2	21.5	27.0	27.4	24.8	22.2	19.1
	STAINLESS STEELS (DIFFICULT) 304, 304L, 316, 316L	≤ 275 Bhn or ≤ 28 HRc	Profile 	≤ 0.5	≤ 1.5	340	RPM	83256	10390	5195	3463	2598	2078	1732	1299
						(272-408)	Fz	0.00003	0.00027	0.0007	0.0014	0.0018	0.0020	0.0022	0.0025
							Feed (ipm)	10.0	11.2	14.5	19.4	18.7	16.6	15.2	13.0
		Slot 	1	≤ 1	270	RPM	66115	8251	4126	2750	2063	1650	1375	1031	
					(216-324)	Fz	0.00003	0.00027	0.0007	0.0014	0.0018	0.0020	0.0022	0.0025	
						Feed (ipm)	7.9	8.9	11.6	15.4	14.9	13.2	12.1	10.3	
STAINLESS STEELS (PH) 13-8 PH, 15-5 PH, 17-4 PH, Custom 450	≤ 325 Bhn or ≤ 35 HRc	Profile 	≤ 0.5	≤ 1.5	310	RPM	75910	9474	4737	3158	2368	1895	1579	1184	
					(248-372)	Fz	0.00003	0.00027	0.0007	0.0014	0.0018	0.0020	0.0022	0.0025	
						Feed (ipm)	9.1	10.2	13.3	17.7	17.1	15.2	13.9	11.8	
	Slot 	1	≤ 1	250	RPM	61218	7640	3820	2547	1910	1528	1273	955		
				(200-300)	Fz	0.00003	0.00027	0.0007	0.0014	0.0018	0.0020	0.0022	0.0025		
					Feed (ipm)	7.3	8.3	10.7	14.3	13.8	12.2	11.2	9.6		
K CAST IRONS (LOW & MEDIUM ALLOY) Gray, Malleable, Ductile	≤ 220 Bhn or ≤ 19 HRc	Profile 	≤ 0.5	≤ 1.5	445	RPM	108968	13599	6800	4533	3400	2720	2267	1700	
					(356-534)	Fz	0.00005	0.00042	0.0011	0.0021	0.0028	0.0031	0.0034	0.0039	
						Feed (ipm)	21.8	22.8	29.9	38.1	38.1	33.7	30.8	26.5	
	Slot 	1	≤ 1	355	RPM	86929	10849	5424	3616	2712	2170	1808	1356		
				(284-426)	Fz	0.00005	0.00042	0.0011	0.0021	0.0028	0.0031	0.0034	0.0039		
					Feed (ipm)	17.4	18.2	23.9	30.4	30.4	26.9	24.6	21.2		

continued on next page

FRACTIONAL Z-Carb-AP

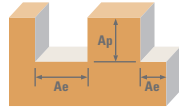

Series	Hardness	Ae x DC	Ap x DC	Vc (sfm)	DC • in									
					1/64	1/8	1/4	3/8	1/2	5/8	3/4	1		
K CAST IRONS (HIGH ALLOY) Gray, Malleable, Ductile	≤ 260 Bhn or ≤ 26 HRc	≤ 0.5	≤ 1.5	340 (272-408)	Profile	RPM	83256	10390	5195	3463	2598	2078	1732	1299
					Fz	0.00004	0.00031	0.0008	0.0016	0.0021	0.0023	0.0025	0.0029	
					Feed (ipm)	13.3	12.9	17.5	22.2	21.8	19.1	17.3	15.1	
					Slot	RPM	66115	8251	4126	2750	2063	1650	1375	1031
						Fz	0.00004	0.00031	0.0008	0.0016	0.0021	0.0023	0.0025	0.0029
						Feed (ipm)	10.6	10.2	13.9	17.6	17.3	15.2	13.8	12.0
S SUPER ALLOYS (NICKEL, COBALT, IRON BASE) Inconel 601, 617, 625, Incoloy, Monel 400	≤ 300 Bhn or ≤ 32 HRc	≤ 0.5	≤ 1.5	80 (64-96)	Profile	RPM	19590	2445	1222	815	611	489	407	306
					Fz	0.00003	0.00025	0.0007	0.0013	0.0017	0.0019	0.0020	0.0024	
					Feed (ipm)	2.4	2.4	3.3	4.2	4.2	3.7	3.3	2.9	
					Slot	RPM	15917	1986	993	662	497	397	331	248
						Fz	0.00003	0.00025	0.0007	0.0013	0.0017	0.0019	0.0020	0.0024
						Feed (ipm)	1.9	2.0	2.7	3.4	3.4	3.0	2.7	2.4
S SUPER ALLOYS (NICKEL, COBALT, IRON BASE) Inconel 718, X-750, Incoloy, Waspaloy, Hastelloy, Rene	≤ 400 Bhn or ≤ 43 HRc	≤ 0.5	≤ 1.5	62 (50-74)	Profile	RPM	15182	1895	947	632	474	379	316	237
					Fz	0.00002	0.00018	0.0005	0.0009	0.0012	0.0013	0.0014	0.0017	
					Feed (ipm)	1.2	1.4	1.8	2.3	2.3	2.0	1.8	1.6	
					Slot	RPM	12244	1528	764	509	382	306	255	191
						Fz	0.00002	0.00018	0.0005	0.0009	0.0012	0.0013	0.0014	0.0017
						Feed (ipm)	1.0	1.1	1.5	1.8	1.8	1.6	1.4	1.3
S TITANIUM ALLOYS Pure Titanium, Ti6Al4V, Ti6Al2Sn4Zr2Mo, Ti4Al4Mo2Sn0.5Si	≤ 350 Bhn or ≤ 38 HRc	≤ 0.5	≤ 1.5	215 (172-258)	Profile	RPM	52647	6570	3285	2190	1643	1314	1095	821
					Fz	0.00003	0.0003	0.0008	0.0015	0.0020	0.0022	0.0024	0.0028	
					Feed (ipm)	6.3	7.9	10.5	13.1	13.1	11.6	10.5	9.2	
					Slot	RPM	41628	5195	2598	1732	1299	1039	866	649
						Fz	0.00003	0.0003	0.0008	0.0015	0.0020	0.0022	0.0024	0.0028
						Feed (ipm)	5.0	6.2	8.3	10.4	10.4	9.1	8.3	7.3
S TITANIUM ALLOYS (DIFFICULT) Ti10Al2Fe3Al, Ti5Al5V5Mo3Cr, Ti7Al4Mo, Ti3Al8V6Cr4Zr4Mo, Ti6Al6V6Sn, Ti15V3Cr3Sn3Al	≤ 440 Bhn or ≤ 47 HRc	≤ 0.5	≤ 1.5	75 (60-90)	Profile	RPM	18365	2292	1146	764	573	458	382	287
					Fz	0.00003	0.0003	0.0008	0.0015	0.0020	0.0022	0.0024	0.0028	
					Feed (ipm)	2.2	2.8	3.7	4.6	4.6	4.0	3.7	3.2	
					Slot	RPM	14692	1834	917	611	458	367	306	229
						Fz	0.00003	0.0003	0.0008	0.0015	0.0020	0.0022	0.0024	0.0028
						Feed (ipm)	1.8	2.2	2.9	3.7	3.7	3.2	2.9	2.6
H TOOL STEELS A2, D2, H13, L2, M2, P20, S7, T15, W2	≤ 375 Bhn or ≤ 40 HRc	≤ 0.5	≤ 1.5	185 (148-222)	Profile	RPM	45301	5654	2827	1885	1413	1131	942	707
					Fz	0.00003	0.00028	0.0007	0.0014	0.0018	0.0020	0.0022	0.0026	
					Feed (ipm)	5.4	6.3	7.9	10.6	10.2	9.0	8.3	7.3	
					Slot	RPM	35506	4431	2216	1477	1108	886	739	554
						Fz	0.00003	0.00028	0.0007	0.0014	0.0018	0.0020	0.0022	0.0026
						Feed (ipm)	4.3	5.0	6.2	8.3	8.0	7.1	6.5	5.8

Bhn (Brinell) HRc (Rockwell C)
 $rpm = Vc \times 3.82 / DC$
 $ipm = Fz \times 4 \times rpm$
 maximum Slotting Ap for Z1PCR <1/8 diameter and all Z1PLC / Z1PLB is .25 x DC
 maximum Profile Ae for Z1PCR <1/8 diameter and all Z1PLC / Z1PLB is .20 x DC
 reduce speed and feed for materials harder than listed
 reduce feed and Ae when finish milling (.02 x DC maximum)
 feed rates listed have chip thinning adjustments included where applicable
 refer to the SGS Tool Wizard® for complete technical information (www.kyocera-sgstool.com)

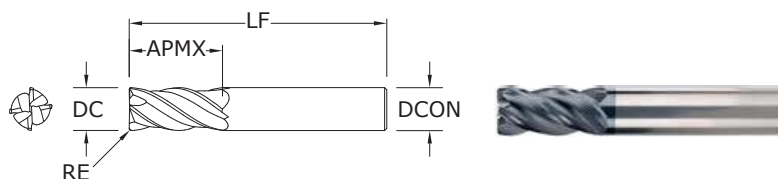
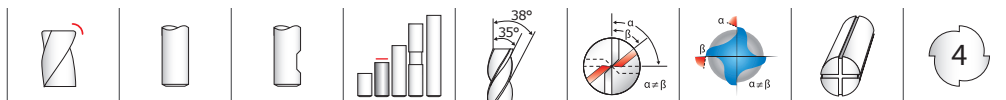

Z1MPCR

METRIC SERIES

TOLERANCES (mm)

<3 DIAMETER

DC = +0,012/-0,012

DCON = h₆

RE = +0,000/-0,025

3-6 DIAMETER

DC = +0,000/-0,030

DCON = h₆

RE = +0,000/-0,050

>6-10 DIAMETER

DC = +0,000/-0,040

DCON = h₆

RE = +0,000/-0,050

>10-25 DIAMETER

DC = +0,000/-0,050

DCON = h₆

RE = +0,000/-0,050

STEELS

STAINLESS STEELS

CAST IRON

HIGH TEMP ALLOYS

TITANIUM

For patent
information visit
www.ksptpatents.com

CUTTING DIAMETER DC	LENGTH OF CUT APMX	mm			EDP NO.		
		OVERALL LENGTH LF	SHANK DIAMETER DCON	CORNER RADIUS RE	Ti-NAMITE-X	Ti-NAMITE-X W/FLAT	JetStream
1,0	3,0	57,0	6,0	0,1	46873*	—	—
1,5	4,5	57,0	6,0	0,1	46849*	—	—
2,0	6,0	57,0	6,0	0,2	46850*	—	—
2,5	7,0	57,0	6,0	0,2	46874*	—	—
3,0	8,0	57,0	6,0	0,3	46851	—	—
3,0	8,0	57,0	6,0	0,5	46880	—	—
4,0	11,0	57,0	6,0	0,3	46852	—	—
4,0	11,0	57,0	6,0	0,5	46881	—	—
5,0	13,0	57,0	6,0	0,3	46853	—	—
6,0	13,0	57,0	6,0	0,25	46882	—	—
6,0	13,0	57,0	6,0	0,5	46854	—	—
6,0	13,0	57,0	6,0	1,0	46855	—	—
6,0	13,0	57,0	6,0	1,5	46884	—	—
8,0	19,0	63,0	8,0	0,5	46856	—	—
8,0	19,0	63,0	8,0	1,0	46857	—	—
8,0	19,0	63,0	8,0	1,5	46886	—	—
8,0	19,0	63,0	8,0	2,0	46887	—	—
10,0	22,0	72,0	10,0	0,5	46858	—	—
10,0	22,0	72,0	10,0	1,0	46859	—	—
10,0	22,0	72,0	10,0	1,5	46889	—	—
10,0	22,0	72,0	10,0	2,0	46890	—	—
10,0	22,0	72,0	10,0	2,5	46891	—	—
12,0	26,0	83,0	12,0	0,5	46860	46909	—
12,0	26,0	83,0	12,0	0,75	46861	46910	46493
12,0	26,0	83,0	12,0	1,0	46893	46911	—
12,0	26,0	83,0	12,0	1,5	46894	46912	—
12,0	26,0	83,0	12,0	2,0	46895	46913	—
12,0	26,0	83,0	12,0	2,5	46896	46914	—
12,0	26,0	83,0	12,0	3,0	42718	46915	42719
14,0	26,0	83,0	14,0	1,0	46862	46916	46494
16,0	32,0	92,0	16,0	1,0	46863	46917	46495
16,0	32,0	92,0	16,0	1,5	46898	46918	—
16,0	32,0	92,0	16,0	2,0	46899	46919	—
16,0	32,0	92,0	16,0	2,5	46900	46920	—
16,0	32,0	92,0	16,0	3,0	46864	46921	42721
16,0	32,0	92,0	16,0	4,0	46867	46944	—
20,0	38,0	104,0	20,0	1,0	46865	46922	46497
20,0	38,0	104,0	20,0	1,5	46903	46923	—
20,0	38,0	104,0	20,0	2,0	46904	46924	—
20,0	38,0	104,0	20,0	2,5	46905	46925	—
20,0	38,0	104,0	20,0	3,0	42722	46926	42723
20,0	38,0	104,0	20,0	4,0	46868	46945	—
20,0	38,0	104,0	20,0	5,0	46869	46946	—
25,0	38,0	104,0	25,0	1,0	46866	46927	46498

*Variable flute spacing. Helix and rake do not vary.

- Variable rake geometry alters and controls the cutting dynamic taking chatter suppression to an unprecedented level
- Unequal helix design changes the cutting angle to improve harmonics
- Unequal flute spacing helps to disrupt the rhythmic pattern created by the cutting edge helping to suppress damaging harmonics
- Enhanced corner geometry with tight tolerance corner radii
- Recommended for materials ≤ 45 HRC (≤ 420 Bhn)

METRIC Z-Carb-AP

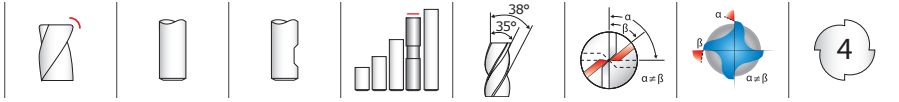

Z1MPIC • Z1MPLC METRIC SERIES

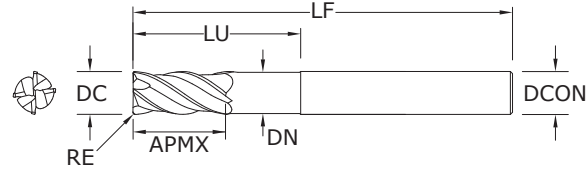

- Variable rake geometry alters and controls the cutting dynamic taking chatter suppression to an unprecedented level
- Unequal helix design changes the cutting angle to improve harmonics
- Unequal flute spacing helps to disrupt the rhythmic pattern created by the cutting edge helping to suppress damaging harmonics
- Long reach design allows for deeper and faster cuts
- Enhanced corner geometry with tight tolerance corner radii
- Recommended for materials ≤ 45 HRc (≤ 420 Bhn)

CUTTING DIAMETER DC	LENGTH OF CUT APMX	OVERALL LENGTH LF	mm				EDP NO.	
			SHANK DIAMETER DCON	REACH LU	NECK DIAMETER DN	CORNER RADIUS RE	Ti-NAMITE-X	Ti-NAMITE-X W/FLAT
6,0	8,0	75,0	6,0	24,0	5,49	0,5	46821	—
8,0	10,0	75,0	8,0	32,0	7,49	1,0	46822	—
8,0	10,0	75,0	8,0	32,0	7,49	2,0	46823	—
10,0	12,0	100,0	10,0	40,0	9,50	1,0	46824	—
10,0	12,0	100,0	10,0	40,0	9,50	2,0	46825	—
12,0	15,0	100,0	12,0	48,0	11,48	1,0	46826	46928
12,0	15,0	100,0	12,0	48,0	11,48	1,5	46827	46929
12,0	15,0	100,0	12,0	48,0	11,48	2,0	46828	46930
12,0	15,0	100,0	12,0	48,0	11,48	3,0	46829	46931
12,0	26,0	83,0	12,0	36,0	11,48	2,5	—	42731
12,0	26,0	83,0	12,0	36,0	11,48	3,0	—	42732
12,0	26,0	83,0	12,0	36,0	11,48	4,0	—	42733
16,0	32,0	92,0	16,0	42,0	15,49	2,5	—	42734
16,0	32,0	92,0	16,0	42,0	15,49	4,0	—	42735
16,0	32,0	92,0	16,0	42,0	15,49	6,0	—	42736
16,0	20,0	115,0	16,0	65,0	15,49	1,0	46830	46932
16,0	20,0	115,0	16,0	65,0	15,49	1,5	46831	46933
16,0	20,0	115,0	16,0	65,0	15,49	2,0	46832	46934
16,0	20,0	115,0	16,0	65,0	15,49	3,0	46833	46935
16,0	20,0	115,0	16,0	65,0	15,49	4,0	46834	46936
16,0	20,0	115,0	16,0	65,0	15,49	5,0	46835	46937
20,0	24,0	140,0	20,0	80,0	19,48	1,0	46836	46938
20,0	24,0	140,0	20,0	80,0	19,48	1,5	46837	46939
20,0	24,0	140,0	20,0	80,0	19,48	2,0	46838	46940
20,0	24,0	140,0	20,0	80,0	19,48	3,0	46839	46941
20,0	24,0	140,0	20,0	80,0	19,48	4,0	46840	46942
20,0	24,0	140,0	20,0	80,0	19,48	5,0	46841	46943
20,0	38,0	104,0	20,0	52,0	19,48	2,5	—	42737
20,0	38,0	104,0	20,0	52,0	19,48	4,0	—	42738
20,0	38,0	104,0	20,0	52,0	19,48	6,0	—	42739

TOLERANCES (mm)

- 6 DIAMETER**
 DC = $+0,000/-0,030$
 DCON = h_6
 RE = $+0,000/-0,050$
- >6-10 DIAMETER**
 DC = $+0,000/-0,040$
 DCON = h_6
 RE = $+0,000/-0,050$
- >10-20 DIAMETER**
 DC = $+0,000/-0,050$
 DCON = h_6
 RE = $+0,000/-0,050$

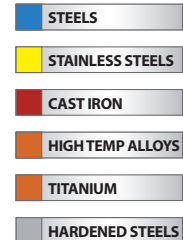

For patent information visit www.ksptpatents.com

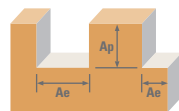

Series Z1M, Z1MPCR, Z1MPIC, Z1MPLC Metric	Hardness	Ae x DC	Ap x DC	Vc (m/min)	DC • mm											
					1	3	6	8	10	12	16	20	25			
P CARBON STEELS 1018, 1040, 1080, 1090, 10L50, 1140, 1212, 12L15, 1525, 1536	≤ 275 Bhn or ≤ 28 HRc	Profile 	≤ 0.5	≤ 1.5	169	RPM	53803	17934	8967	6725	5380	4484	3363	2690	2152	
					(135-203)	Fz	0.0030	0.0109	0.029	0.049	0.061	0.074	0.087	0.099	0.108	
					Feed (mm/min)	646	782	1040	1318	1313	1327	1170	1065	930		
		Slot 	1	≤ 1	134	RPM	42654	14218	7109	5332	4265	3555	2666	2133	1706	
					(107-161)	Fz	0.0030	0.0109	0.029	0.049	0.061	0.074	0.087	0.099	0.108	
					Feed (mm/min)	512	620	825	1045	1041	1052	928	845	737		
	ALLOY STEELS 4140, 4150, 4320, 5120, 5150, 8630, 86L20, 50100	≤ 375 Bhn or ≤ 40 HRc	Profile 	≤ 0.5	≤ 1.5	96	RPM	30537	10179	5089	3817	3054	2545	1909	1527	1221
						(77-115)	Fz	0.0023	0.0081	0.022	0.036	0.045	0.055	0.067	0.075	0.080
						Feed (mm/min)	281	330	448	550	550	560	511	458	391	
			Slot 	1	≤ 1	76	RPM	24235	8078	4039	3029	2424	2020	1515	1212	969
						(61-91)	Fz	0.0023	0.0081	0.022	0.036	0.045	0.055	0.067	0.075	0.080
						Feed (mm/min)	223	262	355	436	436	444	406	364	310	
M STAINLESS STEELS (FREE MACHINING) 303, 416, 420F, 430F, 440F	≤ 275 Bhn or ≤ 28 HRc	Profile 	≤ 0.5	≤ 1.5	149	RPM	47501	15834	7917	5938	4750	3958	2969	2375	1900	
					(119-179)	Fz	0.0023	0.0081	0.022	0.036	0.045	0.055	0.067	0.075	0.080	
					Feed (mm/min)	437	513	697	855	855	871	796	713	608		
		Slot 	1	≤ 1	119	RPM	37807	12602	6301	4726	3781	3151	2363	1890	1512	
					(95-143)	Fz	0.0023	0.0081	0.022	0.036	0.045	0.055	0.067	0.075	0.080	
					Feed (mm/min)	348	408	555	681	681	693	633	567	484		
	STAINLESS STEELS (DIFFICULT) 304, 304L, 316, 316L	≤ 275 Bhn or ≤ 28 HRc	Profile 	≤ 0.5	≤ 1.5	104	RPM	32960	10987	5493	4120	3296	2747	2060	1648	1318
						(83-124)	Fz	0.0018	0.0064	0.017	0.030	0.037	0.043	0.051	0.059	0.063
						Feed (mm/min)	237	281	374	494	488	472	420	389	332	
			Slot 	1	≤ 1	82	RPM	26174	8725	4362	3272	2617	2181	1636	1309	1047
						(66-99)	Fz	0.0018	0.0064	0.017	0.030	0.037	0.043	0.051	0.059	0.063
						Feed (mm/min)	188	223	297	393	387	375	334	309	264	
STAINLESS STEELS (PH) 13-8 PH, 15-5 PH, 17-4 PH, Custom 450	≤ 325 Bhn or ≤ 35 HRc	Profile 	≤ 0.5	≤ 1.5	94	RPM	30052	10017	5009	3756	3005	2504	1878	1503	1202	
					(76-113)	Fz	0.0018	0.0064	0.017	0.030	0.037	0.043	0.051	0.059	0.063	
					Feed (mm/min)	216	256	341	451	445	431	383	355	303		
		Slot 	1	≤ 1	76	RPM	24235	8078	4039	3029	2424	2020	1515	1212	969	
					(61-91)	Fz	0.0018	0.0064	0.017	0.030	0.037	0.043	0.051	0.059	0.063	
					Feed (mm/min)	174	207	275	364	359	347	309	286	244		
K CAST IRONS (LOW & MEDIUM ALLOY) Gray, Malleable, Ductile	≤ 220 Bhn or ≤ 19 HRc	Profile 	≤ 0.5	≤ 1.5	136	RPM	43139	14380	7190	5392	4314	3595	2696	2157	1726	
					(109-163)	Fz	0.0028	0.0099	0.026	0.045	0.056	0.067	0.079	0.091	0.098	
					Feed (mm/min)	483	569	748	971	966	963	852	785	676		
		Slot 	1	≤ 1	108	RPM	34414	11471	5736	4302	3441	2868	2151	1721	1377	
					(87-130)	Fz	0.0028	0.0099	0.026	0.045	0.056	0.067	0.079	0.091	0.098	
					Feed (mm/min)	385	454	597	774	771	769	680	626	540		

continued on next page

Z-Carb-AP

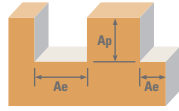

Series
Z1M, Z1MPCR,
Z1MPLC, Z1MPLB
Metric

K	Hardness	Ae x DC	Ap x DC	Vc (m/min)	DC • mm									
					1	3	6	8	10	12	16	20	25	
CAST IRONS (HIGH ALLOY) Gray, Malleable, Ductile	≤ 260 Bhn or ≤ 26 HRc	Profile ≤ 0.5	≤ 1.5	104	RPM	32960	10987	5493	4120	3296	2747	2060	1648	1318
				(83-124)	Fz	0.0020	0.0074	0.020	0.034	0.043	0.050	0.059	0.067	0.074
				Feed (mm/min)	264	325	439	560	567	549	486	442	390	
	Slot	1	≤ 1	82	RPM	26174	8725	4362	3272	2617	2181	1636	1309	1047
				(66-99)	Fz	0.0020	0.0074	0.020	0.034	0.043	0.050	0.059	0.067	0.074
				Feed (mm/min)	209	258	349	445	450	436	386	351	310	
SUPER ALLOYS (NICKEL, COBALT, IRON BASE) Inconel 601, 617, 625, Incoloy, Monel 400	≤ 300 Bhn or ≤ 32 HRc	Profile ≤ 0.5	≤ 1.5	24	RPM	7755	2585	1293	969	776	646	485	388	310
				(20-29)	Fz	0.0018	0.0061	0.016	0.027	0.034	0.041	0.048	0.053	0.060
				Feed (mm/min)	56	63	83	105	105	106	93	82	74	
	Slot	1	≤ 1	20	RPM	6301	2100	1050	788	630	525	394	315	252
				(16-24)	Fz	0.0018	0.0061	0.016	0.027	0.034	0.041	0.048	0.053	0.060
				Feed (mm/min)	45	51	67	85	86	86	76	67	60	
SUPER ALLOYS (NICKEL, COBALT, IRON BASE) Inconel 718, X-750, Incoloy, Waspaloy, Hastelloy, Rene	≤ 400 Bhn or ≤ 43 HRc	Profile ≤ 0.5	≤ 1.5	19	RPM	6010	2003	1002	751	601	501	376	301	240
				(15-23)	Fz	0.0013	0.0043	0.011	0.019	0.024	0.028	0.033	0.037	0.042
				Feed (mm/min)	31	34	44	57	58	56	50	44	40	
	Slot	1	≤ 1	15	RPM	4847	1616	808	606	485	404	303	242	194
				(12-18)	Fz	0.0013	0.0043	0.011	0.019	0.024	0.028	0.033	0.037	0.042
				Feed (mm/min)	25	28	36	46	47	45	40	36	33	
TITANIUM ALLOYS Pure Titanium, Ti6Al4V, Ti6Al2Sn4Zr2Mo, Ti4Al4Mo2Sn0.5Si	≤ 350 Bhn or ≤ 38 HRc	Profile ≤ 0.5	≤ 1.5	66	RPM	20842	6947	3474	2605	2084	1737	1303	1042	834
				(52-79)	Fz	0.0020	0.0071	0.019	0.032	0.040	0.048	0.056	0.064	0.070
				Feed (mm/min)	167	197	264	333	333	333	292	267	233	
	Slot	1	≤ 1	52	RPM	16480	5493	2747	2060	1648	1373	1030	824	659
				(41-62)	Fz	0.0020	0.0071	0.019	0.032	0.040	0.048	0.056	0.064	0.070
				Feed (mm/min)	132	156	209	264	264	264	231	211	185	
TITANIUM ALLOYS (DIFFICULT) Ti10Al2Fe3Al, Ti5Al5V5Mo3Cr, Ti7Al4Mo, Ti3Al8V6Cr4Zr4Mo, Ti6Al6V6Sn, Ti15V3 Cr3Sn3Al	≤ 440 Bhn or ≤ 47 HRc	Profile ≤ 0.5	≤ 1.5	23	RPM	7271	2424	1212	909	727	606	454	364	291
				(18-27)	Fz	0.0020	0.0071	0.019	0.032	0.040	0.048	0.056	0.064	0.070
				Feed (mm/min)	58	69	92	116	116	116	102	93	81	
	Slot	1	≤ 1	18	RPM	5816	1939	969	727	582	485	364	291	233
				(15-22)	Fz	0.0020	0.0071	0.019	0.032	0.040	0.048	0.056	0.064	0.070
				Feed (mm/min)	47	55	74	93	93	93	81	74	65	
TOOL STEELS A2, D2, H13, L2, M2, P20, S7, T15, W2	≤ 375 Bhn or ≤ 40 HRc	Profile ≤ 0.5	≤ 1.5	56	RPM	17934	5978	2989	2242	1793	1495	1121	897	717
				(45-68)	Fz	0.0018	0.0066	0.017	0.030	0.037	0.043	0.051	0.059	0.065
				Feed (mm/min)	129	158	203	269	265	257	229	212	187	
	Slot	1	≤ 1	44	RPM	14057	4686	2343	1757	1406	1171	879	703	562
				(35-53)	Fz	0.0018	0.0066	0.017	0.030	0.037	0.043	0.051	0.059	0.065
				Feed (mm/min)	101	124	159	211	208	201	179	166	146	

Bhn (Brinell) HRc (Rockwell C)
 rpm = (Vc x 1000) / (DC x 3.14)
 mm/min = Fz x 4 x rpm
 maximum Slotting Ap for Z1PCR <3mm diameter and all Z1MPLC / Z1MPLB is .25 x DC
 maximum Profile Ae for Z1PCR <3mm diameter and all Z1MPLC / Z1MPLB is .20 x DC
 reduce speed and feed for materials harder than listed
 reduce feed and Ae when finish milling (.02 x DC maximum)
 feed rates listed have chip thinning adjustments included where applicable
 refer to the SGS Tool Wizard® for complete technical information (www.kyocera-sgstool.com)

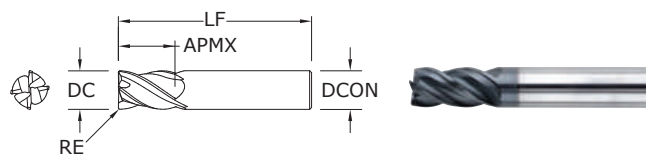

Z1 • Z16CR FRACTIONAL SERIES

TOLERANCES (inch)

1/8–1/4 DIAMETER

DC = +0.0000/–0.0012

DCON = h_6

RE = +0.000/–0.002

>1/4–3/8 DIAMETER

DC = +0.0000/–0.0016

DCON = h_6

RE = +0.000/–0.002

>3/8–3/4 DIAMETER

DC = +0.0000/–0.0020

DCON = h_6

RE = +0.000/–0.002

STEELS

STAINLESS STEELS

CAST IRON

HIGH TEMP ALLOYS

TITANIUM

HARDENED STEELS

For patent
information visit
www.ksptpatents.com

CUTTING DIAMETER DC	LENGTH OF CUT APMX	inch			EDP NO.		
		OVERALL LENGTH LF	SHANK DIAMETER DCON	CORNER RADIUS RE	Ti-NAMITE-X	Ti-NAMITE-X W/FLAT	JetStream
1/8	1/4	1-1/2	1/8	.015	36505	–	–
1/8	3/8	1-1/2	1/8	–	36404	–	–
5/32	5/16	2	3/16	.015	36506	–	–
5/32	7/16	2	3/16	–	36406	–	–
3/16	3/8	2	3/16	.015	36507	–	–
3/16	7/16	2	3/16	–	36408	–	–
7/32	3/8	2	1/4	.020	36508	–	–
1/4	1/2	2-1/2	1/4	–	36416	–	–
1/4	7/16	2	1/4	.020	36509	–	–
1/4	3/4	2-1/2	1/4	–	36596	–	–
9/32	5/8	2-1/2	5/16	–	36418	–	–
5/16	1/2	2	5/16	.020	36511	–	–
5/16	13/16	2-1/2	5/16	–	36420	–	–
11/32	13/16	2-1/2	3/8	–	36422	–	–
3/8	5/8	2	3/8	.020	36513	–	–
3/8	7/8	2-1/2	3/8	–	36424	36530	–
13/32	15/16	2-3/4	7/16	–	36426	36531	–
7/16	5/8	2-1/2	7/16	.020	36515	–	–
7/16	1	2-3/4	7/16	–	36428	36532	–
15/32	1	3	1/2	–	36430	36533	–
1/2	5/8	2-1/2	1/2	.030	36517	–	–
1/2	1	3	1/2	–	36432	36534	36826
1/2	1-1/4	3-1/4	1/2	–	36597	36598	–
9/16	1-1/8	3-1/2	9/16	–	36436	36535	36827
5/8	3/4	3	5/8	.040	36519	–	–
5/8	1-1/4	3-1/2	5/8	–	36440	36536	36828
3/4	1	3	3/4	.040	36520	–	–
3/4	1-1/2	4	3/4	–	36442	36537	36829
1	1-1/2	4	1	–	36444	36538	36830

Refer to page 43 for speed & feed recommendations

- Variable rake geometry alters and controls the cutting dynamic taking chatter suppression to an unprecedented level
- Unequal helix design reduces damaging harmonics by changing the angle at which each cutting edge enters and exits the material
- Unequal flute spacing helps to disrupt the rhythmic pattern created by the cutting edge helping to suppress damaging harmonics
- Optimal material removal rates through increased feed and depths of cut
- Enhanced corner geometry with tight tolerance corner radii
- Recommended for materials ≤ 45 HRc (≤ 420 Bhn)

FRACTIONAL Z-Carb

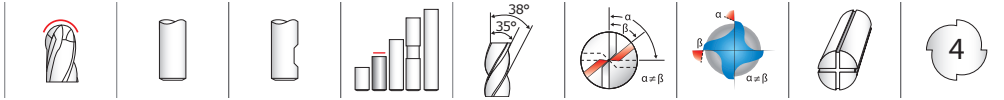

Z1B FRACTIONAL SERIES

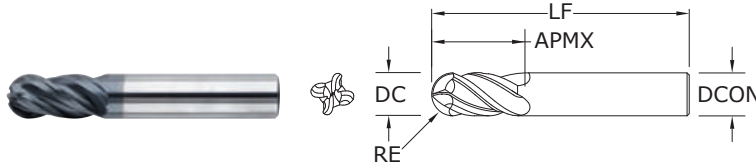

- Unequal helix design reduces damaging harmonics by changing the angle at which each cutting edge enters and exits the material
- Unequal flute spacing helps to disrupt the rhythmic pattern created by the cutting edge helping to suppress damaging harmonics
- Optimal material removal rates through increased feed and depths of cut
- Ball nose design ideal for finishing operations in complex workpieces
- Recommended for materials ≤ 45 HRc (≤ 420 Bhn)

CUTTING DIAMETER DC	inch			EDP NO.		
	LENGTH OF CUT APMX	OVERALL LENGTH LF	SHANK DIAMETER DCON	Ti-NAMITE-X (TX)	Ti-NAMITE-X (TX) W/FLAT	JetStream
1/8	3/8	1-1/2	1/8	36358	—	—
5/32	7/16	2	3/16	36357	—	—
3/16	7/16	2	3/16	36359	—	—
7/32	7/16	2-1/2	1/4	36361	—	—
1/4	1/2	2-1/2	1/4	36344	—	—
1/4	3/4	2-1/2	1/4	36590	—	—
9/32	5/8	2-1/2	5/16	36353	—	—
5/16	13/16	2-1/2	5/16	36345	—	—
11/32	13/16	2-1/2	3/8	36354	—	—
3/8	7/8	2-1/2	3/8	36346	36539	—
13/32	15/16	2-3/4	7/16	36355	36540	—
7/16	1	2-3/4	7/16	36347	36541	—
15/32	1	3	1/2	36356	36542	—
1/2	1	3	1/2	36348	36543	36846
1/2	1-1/4	3-1/4	1/2	36591	36592	—
9/16	1-1/8	3-1/2	9/16	36349	36544	36847
5/8	1-1/4	3-1/2	5/8	36350	36545	36848
3/4	1-1/2	4	3/4	36351	36546	36849
1	1-1/2	4	1	36352	36547	36850

RE = 1/2 Cutting Diameter (DC)

TOLERANCES (inch)

- 1/8–1/4 DIAMETER**
 DC = +0.0000/–0.0012
 DCON = h_6
 RE = +0.0000/–0.0006
- >1/4–3/8 DIAMETER**
 DC = +0.0000/–0.0016
 DCON = h_6
 RE = +0.0000/–0.0008
- >3/8–1 DIAMETER**
 DC = +0.0000/–0.0020
 DCON = h_6
 RE = +0.0000/–0.0010

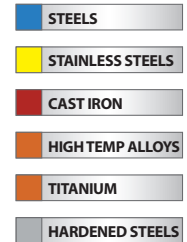

For patent information visit www.ksptpatents.com

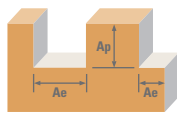

Series Z1B Fractional	Hardness	Ae x DC	Ap x DC	Vc (sfm)	DC • in								
					1/8	1/4	3/8	1/2	5/8	3/4	1		
P	CARBON STEELS 1018, 1040, 1080, 1090, 10L50, 1140, 1212, 12L15, 1525, 1536	Profile 	≤ 0.5	≤ 1.5	555	RPM	16961	8480	5654	4240	3392	2827	2120
					(444-666)	Fz	0.0004	0.0010	0.0019	0.0025	0.0031	0.0032	0.0035
						Feed (ipm)	25.8	33.9	43.0	42.4	42.1	36.5	29.7
		Slot 	1	≤ 1	440	RPM	13446	6723	4482	3362	2689	2241	1681
					(352-528)	Fz	0.0004	0.0010	0.0019	0.0025	0.0031	0.0032	0.0035
						Feed (ipm)	20.4	26.9	34.1	33.6	33.3	29.0	23.5
	ALLOY STEELS 4140, 4150, 4320, 5120, 5150, 8630, 86L20, 50100	Profile 	≤ 0.5	≤ 1.5	315	RPM	9626	4813	3209	2407	1925	1604	1203
					(252-378)	Fz	0.0003	0.0008	0.0014	0.0019	0.0024	0.0025	0.0027
						Feed (ipm)	10.8	15.4	18.0	18.3	18.5	16.0	13.0
		Slot 	1	≤ 1	250	RPM	7640	3820	2547	1910	1528	1273	955
					(200-300)	Fz	0.0003	0.0008	0.0014	0.0019	0.0024	0.0025	0.0027
						Feed (ipm)	8.6	12.2	14.3	14.5	14.7	12.7	10.3
M	STAINLESS STEELS (FREE MACHINING) 303, 416, 420F, 430F, 440F	Profile 	≤ 0.5	≤ 1.5	490	RPM	14974	7487	4991	3744	2995	2496	1872
					(392-588)	Fz	0.0003	0.0007	0.0014	0.0018	0.0023	0.0024	0.0025
						Feed (ipm)	18.0	21.0	28.0	27.0	27.6	24.0	18.7
		Slot 	1	≤ 1	390	RPM	11918	5959	3973	2980	2384	1986	1490
					(312-468)	Fz	0.0003	0.0007	0.0014	0.0018	0.0023	0.0024	0.0025
						Feed (ipm)	14.3	16.7	22.2	21.5	21.9	19.1	14.9
	STAINLESS STEELS (DIFFICULT) 304, 304L, 316, 316L	Profile 	≤ 0.5	≤ 1.5	340	RPM	10390	5195	3463	2598	2078	1732	1299
					(272-408)	Fz	0.0002	0.0006	0.0011	0.0014	0.0018	0.0019	0.0020
						Feed (ipm)	8.3	12.5	15.2	14.5	15.0	13.2	10.4
		Slot 	1	≤ 1	270	RPM	8251	4126	2750	2063	1650	1375	1031
					(216-324)	Fz	0.0002	0.0006	0.0011	0.0014	0.0018	0.0019	0.0020
						Feed (ipm)	6.6	9.9	12.1	11.6	11.9	10.5	8.3
STAINLESS STEELS (PH) 13-8 PH, 15-5 PH, 17-4 PH, Custom 450	Profile 	≤ 0.5	≤ 1.5	310	RPM	9474	4737	3158	2368	1895	1579	1184	
				(248-372)	Fz	0.0002	0.0006	0.0011	0.0014	0.0018	0.0019	0.0020	
					Feed (ipm)	7.6	11.4	13.9	13.3	13.6	12.0	9.5	
	Slot 	1	≤ 1	250	RPM	7640	3820	2547	1910	1528	1273	955	
				(200-300)	Fz	0.0002	0.0006	0.0011	0.0014	0.0018	0.0019	0.0020	
					Feed (ipm)	6.1	9.2	11.2	10.7	11.0	9.7	7.6	
K	CAST IRONS (LOW & MEDIUM ALLOY) Gray, Malleable, Ductile	Profile 	≤ 0.5	≤ 1.5	445	RPM	13599	6800	4533	3400	2720	2267	1700
					(356-534)	Fz	0.0004	0.0010	0.0018	0.0024	0.0030	0.0031	0.0034
						Feed (ipm)	19.0	27.2	32.6	32.6	32.6	28.1	23.1
		Slot 	1	≤ 1	355	RPM	10849	5424	3616	2712	2170	1808	1356
					(284-426)	Fz	0.0004	0.0010	0.0018	0.0024	0.0030	0.0031	0.0034
						Feed (ipm)	15.2	21.7	26.0	26.0	26.0	22.4	18.4

continued on next page

FRACTIONAL Z-Carb

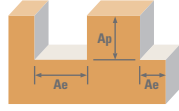

Series Z1B Fractional	Hardness	Ae x DC	Ap x DC	Vc (sfm)	DC • in								
					1/8	1/4	3/8	1/2	5/8	3/4	1		
K	CAST IRONS (HIGH ALLOY) Gray, Malleable, Ductile	≤ 260 Bhn or ≤ 26 HRc	Profile ≤ 0.5	≤ 1.5	340	RPM	10390	5195	3463	2598	2078	1732	1299
					(272-408)	Fz	0.0003	0.0007	0.0014	0.0018	0.0023	0.0024	0.0025
						Feed (ipm)	12.5	14.5	19.4	18.7	19.1	16.6	13.0
					270	RPM	8251	4126	2750	2063	1650	1375	1031
					(216-324)	Fz	0.0003	0.0007	0.0014	0.0018	0.0023	0.0024	0.0025
						Feed (ipm)	9.9	11.6	15.4	14.9	15.2	13.2	10.3
S	SUPER ALLOYS (NICKEL, COBALT, IRON BASE) Inconel 601, 617, 625, Incoloy, Monel 400	≤ 300 Bhn or ≤ 32 HRc	Profile ≤ 0.5	≤ 1.5	80	RPM	2445	1222	815	611	489	407	306
					(64-96)	Fz	0.0002	0.0004	0.0008	0.0010	0.0013	0.0014	0.0015
						Feed (ipm)	2.2	2.0	2.6	2.4	2.5	2.3	1.8
					65	RPM	1986	993	662	497	397	331	248
					(52-78)	Fz	0.0002	0.0004	0.0008	0.0010	0.0013	0.0014	0.0015
						Feed (ipm)	1.6	1.6	2.1	2.0	2.1	1.9	1.5
	SUPER ALLOYS (NICKEL, COBALT, IRON BASE) Inconel 718, X-750, Incoloy, Waspaloy, Hastelloy, Rene	≤ 400 Bhn or ≤ 43 HRc	Profile ≤ 0.5	≤ 1.5	62	RPM	1895	947	632	474	379	316	237
					(50-74)	Fz	0.0001	0.0003	0.0005	0.0007	0.0008	0.0009	0.0010
						Feed (ipm)	0.8	1.1	1.3	1.3	1.2	1.1	0.9
					50	RPM	1497	749	499	374	299	250	187
					(40-60)	Fz	0.0001	0.0003	0.0005	0.0007	0.0008	0.0009	0.0010
						Feed (ipm)	0.6	0.9	1.0	1.0	1.0	0.9	0.7
TITANIUM ALLOYS Pure Titanium, Ti6Al4V, Ti6Al2Sn4Zr2Mo, Ti4Al4Mo2Sn0.5Si	≤ 350 Bhn or ≤ 38 HRc	Profile ≤ 0.5	≤ 1.5	215	RPM	6570	3285	2190	1643	1314	1095	821	
				(172-258)	Fz	0.0002	0.0005	0.0010	0.0013	0.0016	0.0017	0.0018	
					Feed (ipm)	5.3	6.6	8.8	8.5	8.4	7.4	5.9	
				170	RPM	5195	2598	1732	1299	1039	866	649	
				(136-204)	Fz	0.0002	0.0005	0.0010	0.0013	0.0016	0.0017	0.0018	
					Feed (ipm)	4.2	5.2	6.9	6.8	6.6	5.9	4.7	
TITANIUM ALLOYS (DIFFICULT) Ti10Al2Fe3Al, Ti5Al5V5Mo3Cr, Ti7Al4Mo, Ti3Al8V6Cr4Zr4Mo, Ti6Al6V6Sn, Ti15V3 Cr3Sn3Al	≤ 440 Bhn or ≤ 47 HRc	Profile ≤ 0.5	≤ 1.5	75	RPM	2292	1146	764	573	458	382	287	
				(60-90)	Fz	0.0002	0.0005	0.0010	0.0013	0.0016	0.0017	0.0018	
					Feed (ipm)	1.8	2.3	3.1	3.0	2.9	2.6	2.1	
				60	RPM	1834	917	611	458	367	306	229	
				(48-72)	Fz	0.0002	0.0005	0.0010	0.0013	0.0016	0.0017	0.0018	
					Feed (ipm)	1.5	1.8	2.4	2.4	2.3	2.1	1.7	
H	TOOL STEELS A2, D2, H13, L2, M2, P20, S7, T15, W2	≤ 375 Bhn or ≤ 40 HRc	Profile ≤ 0.5	≤ 1.5	185	RPM	5654	2827	1885	1413	1131	942	707
					(148-222)	Fz	0.0002	0.0005	0.0010	0.0013	0.0016	0.0017	0.0018
						Feed (ipm)	4.5	5.7	7.5	7.3	7.2	6.4	5.1
					145	RPM	4431	2216	1477	1108	886	739	554
					(116-174)	Fz	0.0002	0.0005	0.0010	0.0013	0.0016	0.0017	0.0018
						Feed (ipm)	3.5	4.4	5.9	5.8	5.7	5.0	4.0

Bhn (Brinell) HRc (Rockwell C)
 $rpm = Vc \times 3.82 / DC$
 $ipm = Fz \times 4 \times rpm$
 reduce speed and feed for materials harder than listed
 reduce feed and Ae when finish milling (.02 x DC maximum)
 refer to the SGS Tool Wizard® for complete technical information (www.kyocera-sgstool.com)

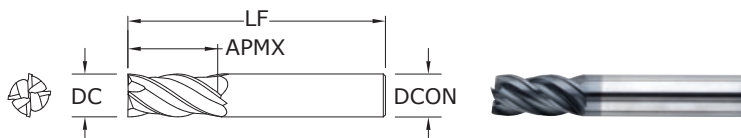
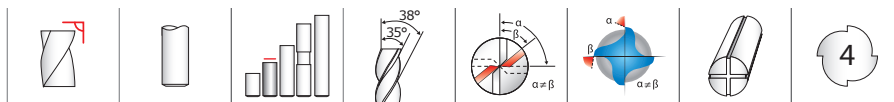

Z1M
METRIC SERIES

TOLERANCES (mm)

3–6 DIAMETER

DC = +0,000/-0,030

DCON = h₆

>6–10 DIAMETER

DC = +0,000/-0,040

DCON = h₆

>10–25 DIAMETER

DC = +0,000/-0,050

DCON = h₆

STEELS

STAINLESS STEELS

CAST IRON

HIGH TEMP ALLOYS

TITANIUM

HARDENED STEELS

CUTTING DIAMETER DC	LENGTH OF CUT APMX	OVERALL LENGTH LF	SHANK DIAMETER DCON	EDP NO.	
				Ti-NAMITE-X (TX)	JetStream
3,0	8,0	57,0	6,0	46357	—
4,0	11,0	57,0	6,0	46358	—
5,0	13,0	57,0	6,0	46359	—
6,0	13,0	57,0	6,0	46360	—
8,0	19,0	63,0	8,0	46362	—
10,0	22,0	72,0	10,0	46364	—
12,0	26,0	83,0	12,0	46366	—
14,0	26,0	83,0	14,0	46368	46506
16,0	32,0	92,0	16,0	46370	46507
18,0	32,0	92,0	18,0	46372	46508
20,0	38,0	104,0	20,0	46374	46509
25,0	38,0	104,0	25,0	46376	46510

Refer to page 47 for speed & feed recommendations

- Variable rake geometry alters and controls the cutting dynamic taking chatter suppression to an unprecedented level
- Unequal helix design reduces damaging harmonics by changing the angle at which each cutting edge enters and exits the material
- Unequal flute spacing helps to disrupt the rhythmic pattern created by the cutting edge helping to suppress damaging harmonics
- Optimal material removal rates through increased feed and depths of cut
- Recommended for materials ≤ 45 HRC (≤ 420 Bhn)

For patent information visit www.ksptpatents.com

METRIC Z-Carb

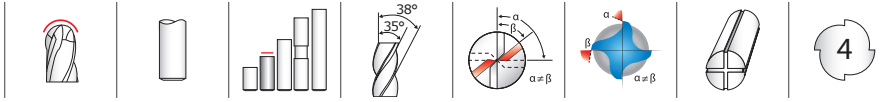

Z1MB METRIC SERIES

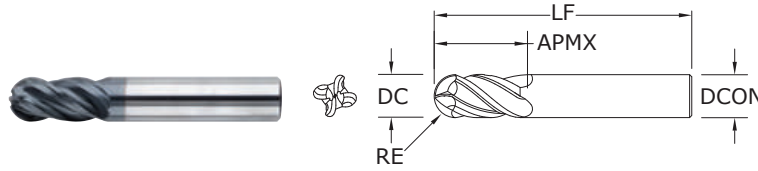

- Unequal helix design reduces damaging harmonics by changing the angle at which each cutting edge enters and exits the material
- Unequal flute spacing helps to disrupt the rhythmic pattern created by the cutting edge helping to suppress damaging harmonics
- Optimal material removal rates through increased feed and depths of cut
- Ball nose design ideal for finishing operations in complex workpieces
- Recommended for materials ≤ 45 HRc (≤ 420 Bhn)

CUTTING DIAMETER DC	LENGTH OF CUT APMX	mm		EDP NO.	
		OVERALL LENGTH LF	SHANK DIAMETER DCON	Ti-NAMITE-X (TX)	JetStream
3,0	8,0	57,0	6,0	46354	—
4,0	11,0	57,0	6,0	46355	—
5,0	13,0	57,0	6,0	46356	—
6,0	13,0	57,0	6,0	46343	—
8,0	19,0	63,0	8,0	46344	—
10,0	22,0	72,0	10,0	46345	—
12,0	26,0	83,0	12,0	46346	—
14,0	26,0	83,0	14,0	46347	46518
16,0	32,0	92,0	16,0	46348	46519
18,0	32,0	92,0	18,0	46349	46520
20,0	38,0	104,0	20,0	46350	46521
25,0	38,0	104,0	25,0	46351	46522

RE = 1/2 Cutting Diameter (DC)

TOLERANCES (mm)

3–6 DIAMETER

DC = $+0,000/-0,030$
DCON = h_6

RE = $+0,000/-0,015$

>6–10 DIAMETER

DC = $+0,000/-0,040$

DCON = h_6

RE = $+0,000/-0,020$

>10–25 DIAMETER

DC = $+0,000/-0,050$

DCON = h_6

RE = $+0,000/-0,025$

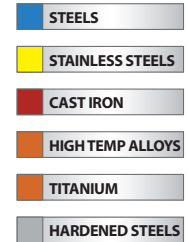

For patent information visit www.ksptpatents.com

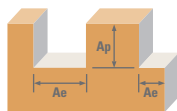

Series Z1MB Metric	Hardness	Ae x DC	Ap x DC	Vc (m/min)	DC • mm										
					3	6	8	10	12	16	20	25			
P CARBON STEELS 1018, 1040, 1080, 1090, 10L50, 1140, 1212, 12L15, 1525, 1536	≤ 275 Bhn or ≤ 28 HRc	Profile 	≤ 0.5	≤ 1.5	169	RPM	17934	8967	6725	5380	4484	3363	2690	2152	
					(135-203)	Fz	0.009	0.024	0.041	0.051	0.060	0.079	0.086	0.088	
					Feed (mm/min)	654	861	1091	1090	1076	1067	927	753		
		Slot 	1	≤ 1	134	RPM	14218	7109	5332	4265	3555	2666	2133	1706	
					(107-161)	Fz	0.009	0.024	0.041	0.051	0.060	0.079	0.086	0.088	
					Feed (mm/min)	519	682	865	864	853	846	735	597		
	ALLOY STEELS 4140, 4150, 4320, 5120, 5150, 8630, 86L20, 50100	≤ 375 Bhn or ≤ 40 HRc	Profile 	≤ 0.5	≤ 1.5	96	RPM	10179	5089	3817	3054	2545	1909	1527	1221
						(77-115)	Fz	0.007	0.019	0.030	0.037	0.046	0.061	0.067	0.068
						Feed (mm/min)	274	391	456	456	464	469	407	330	
			Slot 	1	≤ 1	76	RPM	8078	4039	3029	2424	2020	1515	1212	969
						(61-91)	Fz	0.007	0.019	0.030	0.037	0.046	0.061	0.067	0.068
						Feed (mm/min)	217	310	362	362	368	372	323	262	
M STAINLESS STEELS (FREE MACHINING) 303, 416, 420F, 430F, 440F	≤ 275 Bhn or ≤ 28 HRc	Profile 	≤ 0.5	≤ 1.5	149	RPM	15834	7917	5938	4750	3958	2969	2375	1900	
					(119-179)	Fz	0.007	0.017	0.030	0.037	0.043	0.059	0.064	0.063	
					Feed (mm/min)	456	532	709	709	684	699	608	475		
		Slot 	1	≤ 1	119	RPM	12602	6301	4726	3781	3151	2363	1890	1512	
					(95-143)	Fz	0.007	0.017	0.030	0.037	0.043	0.059	0.064	0.063	
					Feed (mm/min)	363	423	565	565	544	557	484	378		
	STAINLESS STEELS (DIFFICULT) 304, 304L, 316, 316L	≤ 275 Bhn or ≤ 28 HRc	Profile 	≤ 0.5	≤ 1.5	104	RPM	10987	5493	4120	3296	2747	2060	1648	1318
						(83-124)	Fz	0.005	0.014	0.023	0.029	0.034	0.046	0.051	0.050
						Feed (mm/min)	211	316	387	387	369	380	334	264	
			Slot 	1	≤ 1	82	RPM	8725	4362	3272	2617	2181	1636	1309	1047
						(66-99)	Fz	0.005	0.014	0.023	0.029	0.034	0.046	0.051	0.050
						Feed (mm/min)	168	251	307	307	293	302	265	209	
STAINLESS STEELS (PH) 13-8 PH, 15-5 PH, 17-4 PH, Custom 450	≤ 325 Bhn or ≤ 35 HRc	Profile 	≤ 0.5	≤ 1.5	94	RPM	10017	5009	3756	3005	2504	1878	1503	1202	
					(76-113)	Fz	0.005	0.014	0.023	0.029	0.034	0.046	0.051	0.050	
					Feed (mm/min)	192	288	353	353	337	346	305	240		
		Slot 	1	≤ 1	76	RPM	8078	4039	3029	2424	2020	1515	1212	969	
					(61-91)	Fz	0.005	0.014	0.023	0.029	0.034	0.046	0.051	0.050	
					Feed (mm/min)	155	233	284	284	271	279	246	194		
K CAST IRONS (LOW & MEDIUM ALLOY) Gray, Malleable, Ductile	≤ 220 Bhn or ≤ 19 HRc	Profile 	≤ 0.5	≤ 1.5	136	RPM	14380	7190	5392	4314	3595	2696	2157	1726	
					(109-163)	Fz	0.008	0.024	0.038	0.048	0.058	0.077	0.083	0.085	
					Feed (mm/min)	483	690	828	828	828	828	713	587		
		Slot 	1	≤ 1	108	RPM	11471	5736	4302	3441	2868	2151	1721	1377	
					(87-130)	Fz	0.008	0.024	0.038	0.048	0.058	0.077	0.083	0.085	
					Feed (mm/min)	385	551	661	661	661	661	569	468		

continued on next page

METRIC Z-Carb

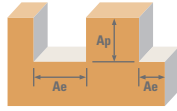

Series Z1MB Metric	Hardness	Ae x DC	Ap x DC	Vc (m/min)	DC • mm															
					3	6	8	10	12	16	20	25								
K	CAST IRONS (HIGH ALLOY) Gray, Malleable, Ductile	≤ 260 Bhn or ≤ 26 HRc	Profile 	≤ 0.5	≤ 1.5	104	RPM	10987	5493	4120	3296	2747	2060	1648	1318					
						(83-124)	Fz	0.007	0.017	0.030	0.037	0.043	0.059	0.064	0.063					
						Feed (mm/min)	316	369	492	492	475	485	422	330						
						82	RPM	8725	4362	3272	2617	2181	1636	1309	1047					
						(66-99)	Fz	0.007	0.017	0.030	0.037	0.043	0.059	0.064	0.063					
						Feed (mm/min)	251	293	391	391	377	385	335	262						
S	SUPER ALLOYS (NICKEL, COBALT, IRON BASE) Inconel 601, 617, 625, Incoloy, Monel 400	≤ 300 Bhn or ≤ 32 HRc	Profile 	≤ 0.5	≤ 1.5	24	RPM	2585	1293	969	776	646	485	388	310					
						(20-29)	Fz	0.005	0.010	0.017	0.021	0.024	0.033	0.037	0.038					
						Feed (mm/min)	55	50	66	53	62	65	58	47						
						20	RPM	2100	1050	788	630	525	394	315	252					
						(16-24)	Fz	0.005	0.010	0.017	0.021	0.024	0.033	0.037	0.038					
						Feed (mm/min)	40	40	54	54	50	52	47	38						
						SUPER ALLOYS (NICKEL, COBALT, IRON BASE) Inconel 718, X-750, Incoloy, Waspaloy, Hastelloy, Rene	≤ 400 Bhn or ≤ 43 HRc	Profile 	≤ 0.5	≤ 1.5	19	RPM	2003	1002	751	601	501	376	301	240
											(15-23)	Fz	0.002	0.007	0.011	0.013	0.017	0.020	0.024	0.025
											Feed (mm/min)	19	29	32	32	34	31	29	24	
											15	RPM	1583	792	594	475	396	297	238	190
											(12-18)	Fz	0.002	0.007	0.011	0.013	0.017	0.020	0.024	0.025
											Feed (mm/min)	15	23	25	25	27	24	23	19	
TITANIUM ALLOYS Pure Titanium, Ti6Al4V, Ti6Al2Sn4Zr2Mo, Ti4Al4Mo2Sn0.5Si	≤ 350 Bhn or ≤ 38 HRc	Profile 	≤ 0.5	≤ 1.5	66	RPM	6947	3474	2605	2084	1737	1303	1042	834						
					(52-79)	Fz	0.005	0.012	0.021	0.027	0.031	0.041	0.045	0.045						
					Feed (mm/min)	133	167	222	222	217	213	189	150							
					52	RPM	5493	2747	2060	1648	1373	1030	824	659						
					(41-62)	Fz	0.005	0.012	0.021	0.027	0.031	0.041	0.045	0.045						
					Feed (mm/min)	105	132	176	176	171	169	149	119							
TITANIUM ALLOYS (DIFFICULT) Ti10Al2Fe3Al, Ti5Al5V5Mo3Cr, Ti7Al4Mo, Ti3Al8V6Cr4Zr4Mo, Ti6Al6V6Sn, Ti15V3 Cr3Sn3Al	≤ 440 Bhn or ≤ 47 HRc	Profile 	≤ 0.5	≤ 1.5	23	RPM	2424	1212	909	727	606	454	364	291						
					(18-27)	Fz	0.005	0.012	0.021	0.027	0.031	0.041	0.045	0.045						
					Feed (mm/min)	47	58	78	78	76	74	66	52							
					18	RPM	1939	969	727	582	485	364	291	233						
					(15-22)	Fz	0.005	0.012	0.021	0.027	0.031	0.041	0.045	0.045						
					Feed (mm/min)	37	47	62	62	60	60	53	42							
H	TOOL STEELS A2, D2, H13, L2, M2, P20, S7, T15, W2	≤ 375 Bhn or ≤ 40 HRc	Profile 	≤ 0.5	≤ 1.5	56	RPM	5978	2989	2242	1793	1495	1121	897	717					
						(45-68)	Fz	0.005	0.012	0.021	0.027	0.031	0.041	0.045	0.045					
						Feed (mm/min)	115	143	191	191	186	184	163	129						
						44	RPM	4686	2343	1757	1406	1171	879	703	562					
						(35-53)	Fz	0.005	0.012	0.021	0.027	0.031	0.041	0.045	0.045					
						Feed (mm/min)	90	112	150	150	146	144	127	101						

Bhn (Brinell) HRc (Rockwell C)

rpm = (Vc x 1000) / (DC x 3.14)

mm/min = Fz x 4 x rpm

reduce speed and feed for materials harder than listed

reduce feed and Ae when finish milling (.02 x DC maximum)

feed rates listed have chip thinning adjustments included where applicable

refer to the SGS Tool Wizard® for complete technical information (www.kyocera-sgstool.com)

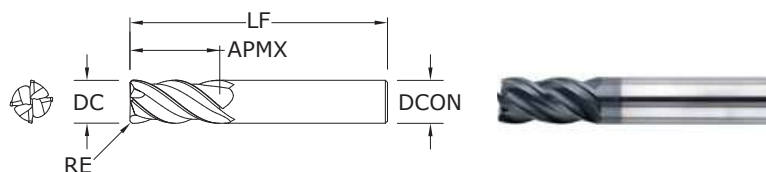
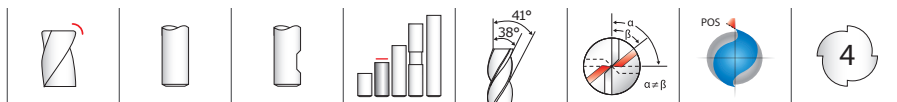

ZH1CR
FRACTIONAL SERIES

TOLERANCES (inch)

1/4 DIAMETER

DC = +0.0000/-0.0012

DCON = h_6

RE = +0.0000/-0.0020

>1/4-3/8 DIAMETER

DC = +0.0000/-0.0016

DCON = h_6

RE = +0.0000/-0.0020

>3/8-1 DIAMETER

DC = +0.0000/-0.0020

DCON = h_6

RE = +0.0000/-0.0020

HIGH TEMP ALLOYS

TITANIUM







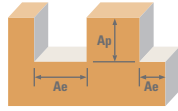

For patent information visit
www.ksptpatents.com

CUTTING DIAMETER DC	LENGTH OF CUT APMX	inch			EDP NO.	
		OVERALL LENGTH LF	SHANK DIAMETER DCON	CORNER RADIUS RE	Ti-NAMITE-A (AlTiN)	Ti-NAMITE-A (AlTiN) W/FLAT
1/4	1/2	2-1/2	1/4	.020	36570	—
1/4	3/4	2-1/2	1/4	.020	36616	—
5/16	13/16	2-1/2	5/16	.020	36571	—
3/8	7/8	2-1/2	3/8	.020	36572	36555
7/16	1	2-3/4	7/16	.020	36573	36556
1/2	1	3	1/2	.030	36574	36557
1/2	1-1/4	3-1/4	1/2	.030	36618	36617
9/16	1-1/8	3-1/2	9/16	.030	36575	36558
5/8	1-1/4	3-1/2	5/8	.040	36576	36559
3/4	1-1/2	4	3/4	.040	36577	36560
1	1-1/2	4	1	.040	36578	36561

- The original Z-Carb design with an enhanced core and higher helix suited for the demands of high temperature alloys
- Unequal flute spacing helps to disrupt the rhythmic pattern created by the cutting edge helping to suppress damaging harmonics
- Optimal material removal rates through increased feed and depths of cut for difficult to machine materials
- Enhanced corner geometry with tight tolerance corner radii
- Recommended for materials ≤ 45 HRc (≤ 420 Bhn)

FRACTIONAL Z-Carb-HTA



Series ZH1CR Fractional	Hardness	Ae x DC	Ap x DC	Vc (sfm)	Diameter (DC) (inch)					
					1/4	3/8	1/2	3/4	1	
SUPER ALLOYS (NICKEL, COBALT, IRON BASE) Inconel 601, 617, 625, Incoloy, Monel 400	Profile  ≤ 300 Bhn or ≤ 32 HRc	≤ 0.5	≤ 1.5	85	RPM	1299	866	649	433	325
				(68-102)	Fz	0.0007	0.0012	0.0017	0.0020	0.0023
					Feed (ipm)	3.6	4.2	4.4	3.5	3.0
	Slot  1	≤ 1	70	RPM	1070	713	535	357	267	
			(56-84)	Fz	0.0007	0.0012	0.0017	0.0020	0.0023	
				Feed (ipm)	3.0	3.4	3.6	2.9	2.5	
SUPER ALLOYS (NICKEL, COBALT, IRON BASE) Inconel 718, X-750, Incoloy, Waspaloy, Hastelloy, Rene	Profile  ≤ 400 Bhn or ≤ 43 HRc	≤ 0.5	≤ 1.5	70	RPM	1070	713	535	357	267
				(56-84)	Fz	0.0005	0.0009	0.0012	0.0014	0.0016
					Feed (ipm)	2.1	2.6	2.6	2.0	1.7
	Slot  1	≤ 1	55	RPM	840	560	420	280	210	
			(44-66)	Fz	0.0005	0.0009	0.0012	0.0014	0.0016	
				Feed (ipm)	1.7	2.0	2.0	1.6	1.3	
TITANIUM ALLOYS Pure Titanium, Ti6Al4V, Ti6Al2Sn4Zr2Mo, Ti4Al4Mo2Sn0.5Si	Profile  ≤ 350 Bhn or ≤ 38 HRc	≤ 0.5	≤ 1.5	215	RPM	3285	2190	1643	1095	821
				(172-258)	Fz	0.0008	0.0015	0.0020	0.0024	0.0028
					Feed (ipm)	10.5	13.1	13.1	10.5	9.2
	Slot  1	≤ 1	170	RPM	2598	1732	1299	866	649	
			(136-204)	Fz	0.0008	0.0015	0.0020	0.0024	0.0028	
				Feed (ipm)	8.3	10.4	10.4	8.3	7.3	
TITANIUM ALLOYS (DIFFICULT) Ti10Al2Fe3Al, Ti5Al5V5Mo3Cr, Ti7Al4Mo, Ti3Al8V6Cr4Zr4Mo, Ti6Al6V6Sn, Ti15V3 Cr3Sn3Al	Profile  ≤ 440 Bhn or ≤ 47 HRc	≤ 0.5	≤ 1.5	75	RPM	1146	764	573	382	287
				(60-90)	Fz	0.0008	0.0015	0.0020	0.0024	0.0028
					Feed (ipm)	3.7	4.6	4.6	3.7	3.2
	Slot  1	≤ 1	60	RPM	917	611	458	306	229	
			(48-72)	Fz	0.0008	0.0015	0.0020	0.0024	0.0028	
				Feed (ipm)	2.9	3.7	3.7	2.9	2.6	

Bhn (Brinell) HRc (Rockwell C)

rpm = Vc x 3.82 / DC

ipm = Fz x 4 x rpm

reduce speed and feed for materials harder than listed

reduce feed and Ae when finish milling (.02 x DC maximum)

feed rates listed have chip thinning adjustments included where applicable

refer to the SGS Tool Wizard® for complete technical information (www.kyocera-sgstool.com)

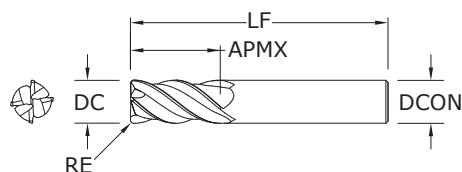

**ZH1MCRS •
ZH1MCR**
METRIC SERIES

TOLERANCES (mm)

6 DIAMETER

DC = +0,000/-0,030

DCON = h_6

RE = +0,000/-0,050

>6-10 DIAMETER

DC = +0,000/-0,040

DCON = h_6

RE = +0,000/-0,050

>10-20 DIAMETER

DC = +0,000/-0,050

DCON = h_6

RE = +0,000/-0,050

HIGH TEMP ALLOYS

TITANIUM







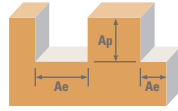

For patent
information visit
www.ksptpatents.com

CUTTING DIAMETER DC	LENGTH OF CUT APMX	mm			EDP NO.	
		OVERALL LENGTH LF	SHANK DIAMETER DCON	CORNER RADIUS RE	Ti-NAMITE-A (AlTiN)	Ti-NAMITE-A (AlTiN) W/FLAT
6,0	10,0	54,0	6,0	0,50	—	42712
6,0	13,0	57,0	6,0	0,5	46450	—
6,0	13,0	57,0	6,0	1,0	46451	—
6,0	13,0	57,0	6,0	1,5	46452	—
8,0	12,0	58,0	8,0	0,50	—	42713
8,0	19,0	63,0	8,0	0,5	46453	—
8,0	19,0	63,0	8,0	1,0	46454	—
8,0	19,0	63,0	8,0	1,5	46455	—
10,0	14,0	66,0	10,0	0,50	—	42714
10,0	22,0	72,0	10,0	0,5	46456	—
10,0	22,0	72,0	10,0	1,0	46457	—
10,0	22,0	72,0	10,0	1,5	46458	—
10,0	22,0	72,0	10,0	2,0	46459	—
12,0	16,0	73,0	12,0	0,75	—	42715
12,0	26,0	83,0	12,0	0,5	46460	46471
12,0	26,0	83,0	12,0	1,0	46461	46472
12,0	26,0	83,0	12,0	1,5	46462	46473
12,0	26,0	83,0	12,0	2,0	46463	46474
12,0	26,0	83,0	12,0	3,0	46464	46475
16,0	22,0	82,0	16,0	1,00	—	42716
16,0	32,0	92,0	16,0	1,5	46465	46476
16,0	32,0	92,0	16,0	2,0	46466	46477
16,0	32,0	92,0	16,0	3,0	46467	46478
16,0	32,0	92,0	16,0	4,0	46482	46483
20,0	26,0	92,0	20,0	1,00	—	42717
20,0	38,0	104,0	20,0	3,0	46468	46479
20,0	38,0	104,0	20,0	4,0	46469	46480
20,0	38,0	104,0	20,0	5,0	46470	46481

- The original Z-Carb design with an enhanced core and higher helix suited for the demands of high temperature alloys
- Unequal flute spacing helps to disrupt the rhythmic pattern created by the cutting edge helping to suppress damaging harmonics
- Optimal material removal rates through increased feed and depths of cut for difficult to machine materials
- Enhanced corner geometry with tight tolerance corner radii
- Recommended for materials ≤ 45 HRc (≤ 420 Bhn)

Z-Carb-HTA



Series ZH1MCRS, ZH1MCR Metric	Hardness	Ae x DC	Ap x DC	Vc (m/min)	DC • mm					
					6	10	12	20		
SUPER ALLOYS (NICKEL, COBALT, IRON BASE) Inconel 601, 617, 625, Incoloy, Monel 400	≤ 300 Bhn or ≤ 32 HRc	Profile 	≤ 0.5	≤ 1.5	26	RPM	1373	824	687	412
					(21-31)	Fz	0.017	0.032	0.041	0.053
					Feed (mm/min)	93	105	113	87	
	Slot 	1	≤ 1	21	RPM	1131	679	565	339	
				(17-26)	Fz	0.017	0.032	0.041	0.053	
				Feed (mm/min)	77	87	93	72		
SUPER ALLOYS (NICKEL, COBALT, IRON BASE) Inconel 718, X-750, Incoloy, Waspaloy, Hastelloy, Rene	≤ 400 Bhn or ≤ 43 HRc	Profile 	≤ 0.5	≤ 1.5	21	RPM	1131	679	565	339
					(17-26)	Fz	0.012	0.024	0.029	0.037
					Feed (mm/min)	54	65	66	50	
	Slot 	1	≤ 1	17	RPM	889	533	444	267	
				(13-20)	Fz	0.012	0.024	0.029	0.037	
				Feed (mm/min)	43	51	52	39		
TITANIUM ALLOYS Pure Titanium, Ti6Al4V, Ti6Al2Sn4Zr2Mo, Ti4Al4Mo2Sn0.5Si	≤ 350 Bhn or ≤ 38 HRc	Profile 	≤ 0.5	≤ 1.5	66	RPM	3474	2084	1737	1042
					(52-79)	Fz	0.019	0.041	0.049	0.057
					Feed (mm/min)	264	342	340	238	
	Slot 	1	≤ 1	52	RPM	2747	1648	1373	824	
				(41-62)	Fz	0.019	0.041	0.049	0.057	
				Feed (mm/min)	209	270	269	188		
TITANIUM ALLOYS (DIFFICULT) Ti10Al2Fe3Al, Ti5Al5V5Mo3Cr, Ti7Al4Mo, Ti3Al8V6Cr4Zr4Mo, Ti6Al6V6Sn, Ti15V3 Cr3Sn3Al	≤ 440 Bhn or ≤ 47 HRc	Profile 	≤ 0.5	≤ 1.5	23	RPM	1212	727	606	364
					(18-27)	Fz	0.019	0.041	0.049	0.057
					Feed (mm/min)	92	119	119	83	
	Slot 	1	≤ 1	18	RPM	969	582	485	291	
				(15-22)	Fz	0.019	0.041	0.049	0.057	
				Feed (mm/min)	74	95	95	66		

Bhn (Brinell) HRc (Rockwell C)
 rpm = (Vc x 1000) / (DC x 3.14)
 ipm = Fz x 4 x rpm
 reduce speed and feed for materials harder than listed
 reduce feed and Ae when finish milling (.02 x DC maximum)
 feed rates listed have chip thinning adjustments included where applicable
 refer to the SGS Tool Wizard® for complete technical information (www.kyocera-sgstool.com)

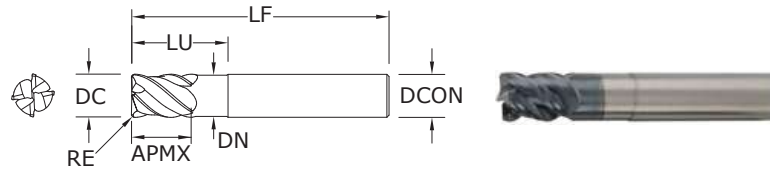

ZD1CR FRACTIONAL SERIES

TOLERANCES (inch)

1/8–1/4 DIAMETER

DC = +0.0000/-0.0012

DCON = h₆

RE = +0.0000/-0.0020

>1/4–3/8 DIAMETER

DC = +0.0000/-0.0016

DCON = h₆

RE = +0.0000/-0.0020

>3/8–3/4 DIAMETER

DC = +0.0000/-0.0020

DCON = h₆

RE = +0.0000/-0.0020

HARDENED STEELS

For patent information visit www.ksptpatents.com

CUTTING DIAMETER DC	LENGTH OF CUT APMX	OVERALL LENGTH LF	inch				CORNER RADIUS RE	EDP NO. Ti-NAMITE-X
			SHANK DIAMETER DCON	REACH LU	NECK DIAMETER DN			
1/8	5/32	2-1/2	1/4	1/2	.110	.010	36780	
3/16	7/32	2-1/2	1/4	3/4	.172	.020	36781	
1/4	9/32	2-1/2	1/4	3/4	.235	.020	36782	
5/16	13/32	2-1/2	5/16	1	.297	.040	36783	
3/8	15/32	2-1/2	3/8	1	.360	.040	36784	
7/16	9/16	2-3/4	7/16	1	.422	.040	36785	
1/2	5/8	3	1/2	1-1/4	.485	.040	36786	
1/2	5/8	4-1/2	1/2	2-1/4	.485	.040	36787	
5/8	3/4	3-1/2	5/8	1-1/2	.610	.040	36788	
5/8	3/4	4-1/2	5/8	2-1/4	.610	.040	36789	
5/8	3/4	5-1/2	5/8	3-1/4	.610	.040	36790	
3/4	15/16	4	3/4	1-3/4	.735	.060	36791	
3/4	15/16	4-1/2	3/4	2-1/4	.735	.060	36792	
3/4	15/16	5-1/2	3/4	3-1/4	.735	.060	36793	

- The original Z-Carb design with negative rake, heavy core, and higher helix for strength and shearing of hard mold & die materials
- Unequal flute spacing helps to disrupt the rhythmic pattern created by the cutting edge helping to suppress damaging harmonics
- Enhanced corner geometry with tight tolerance corner radii
- Recommended for materials 35-60HRC (327 to 654 Bhn)

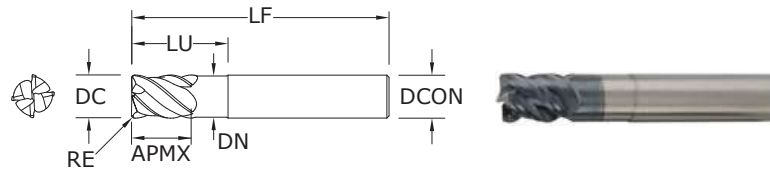

ZD1MCR METRIC SERIES

TOLERANCES (mm)

3–6 DIAMETER

DC = +0,000/-0,030

DCON = h₆

RE = +0,000/-0,050

>6–10 DIAMETER

DC = +0,000/-0,040

DCON = h₆

RE = +0,000/-0,050

>10–20 DIAMETER

DC = +0,000/-0,050

DCON = h₆

RE = +0,000/-0,050

HARDENED STEELS

For patent information visit www.ksptpatents.com

CUTTING DIAMETER DC	LENGTH OF CUT APMX	OVERALL LENGTH LF	mm				CORNER RADIUS RE	EDP NO. Ti-NAMITE-X
			SHANK DIAMETER DCON	REACH LU	NECK DIAMETER DN			
3,0	4,0	57,0	6,0	15,0	2,62	0,2	46560	
4,0	5,0	57,0	6,0	15,0	3,61	0,3	46561	
5,0	6,0	57,0	6,0	15,0	4,60	0,5	46562	
6,0	7,0	57,0	6,0	15,0	5,61	1,0	46563	
8,0	10,0	63,0	8,0	25,0	7,62	1,0	46564	
10,0	12,0	72,0	10,0	30,0	9,60	1,0	46565	
12,0	15,0	83,0	12,0	35,0	11,61	1,0	46566	
16,0	20,0	92,0	16,0	45,0	15,60	1,5	46567	
20,0	24,0	104,0	20,0	55,0	19,61	2,0	46568	

- The original Z-Carb design with negative rake, heavy core, and higher helix for strength and shearing of hard mold & die materials
- Unequal flute spacing helps to disrupt the rhythmic pattern created by the cutting edge helping to suppress damaging harmonics
- Enhanced corner geometry with tight tolerance corner radii
- Recommended for materials 35-60HRC (327 to 654 Bhn)

FRACTIONAL & METRIC Z-Carb-MD

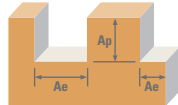

Series ZD1CR Fractional	Hardness	Ae x DC	Ap x DC	Vc (sfm)	Diameter (DC) (inch)							
					1/8	1/4	3/8	1/2	5/8	3/4		
TOOL STEELS A2, D2, H13, L2, M2, P20, S7, T15, W2	≤ 375 Bhn or ≤ 40 HRc	Profile 	≤ 0.4	≤ 1	405	RPM	12377	6188	4126	3094	2475	2063
					(324-486)	Fz	0.0005	0.0012	0.0023	0.0030	0.0039	0.0042
						Feed (ipm)	24.8	29.7	38.0	37.1	38.6	34.7
	≤ 475 Bhn or ≤ 50 HRc	Slot 	1	≤ 0.4	320	RPM	9779	4890	3260	2445	1956	1630
					(256-384)	Fz	0.0005	0.0012	0.0023	0.0030	0.0039	0.0042
						Feed (ipm)	19.6	23.5	30.0	29.3	30.5	27.4
H TOOL STEELS A2, D2, H13, L2, M2, P20, S7, T15, W2	≤ 475 Bhn or ≤ 50 HRc	Profile 	≤ 0.4	≤ 1	210	RPM	6418	3209	2139	1604	1284	1070
					(168-252)	Fz	0.0004	0.0010	0.0019	0.0025	0.0032	0.0035
						Feed (ipm)	10.3	12.8	16.3	16.0	16.4	15.0
	≤ 655 Bhn or ≤ 60 HRc	Slot 	1	≤ 0.4	170	RPM	5195	2598	1732	1299	1039	866
					(136-204)	Fz	0.0004	0.0010	0.0019	0.0025	0.0032	0.0035
						Feed (ipm)	8.3	10.4	13.2	13.0	13.3	12.1
TOOL STEELS A2, D2, H13, L2, M2, P20, S7, T15, W2	≤ 655 Bhn or ≤ 60 HRc	Profile 	≤ 0.4	≤ 1	90	RPM	2750	1375	917	688	550	458
					(72-108)	Fz	0.0002	0.0005	0.0010	0.0013	0.0017	0.0018
						Feed (ipm)	2.2	2.8	3.7	3.6	3.7	3.3
TOOL STEELS A2, D2, H13, L2, M2, P20, S7, T15, W2	≤ 655 Bhn or ≤ 60 HRc	Slot 	1	≤ 0.4	70	RPM	2139	1070	713	535	428	357
					(56-84)	Fz	0.0002	0.0005	0.0010	0.0013	0.0017	0.0018
						Feed (ipm)	1.7	2.1	2.9	2.8	2.9	2.6

Bhn (Brinell) HRc (Rockwell C)
 $rpm = Vc \times 3.82 / DC$
 $ipm = Fz \times 4 \times rpm$
 reduce speed and feed for materials harder than listed
 reduce feed and Ae when finish milling (.02 x DC maximum)
 feed rates listed have chip thinning adjustments included where applicable
 refer to the SGS Tool Wizard® for complete technical information (www.kyocera-sgstool.com)

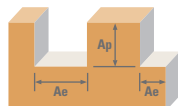

Series ZD1MCR Metric	Hardness	Ae x DC	Ap x DC	Vc (m/min)	Diameter (DC) (mm)								
					3	6	8	10	12	16	20		
TOOL STEELS A2, D2, H13, L2, M2, P20, S7, T15, W2	≤ 375 Bhn or ≤ 40 HRc	Profile 	≤ 0.4	≤ 1	123	RPM	13087	6544	4908	3926	3272	2454	1963
					(99-148)	Fz	0.012	0.029	0.049	0.061	0.072	0.083	0.112
						Feed (mm/min)	628	754	963	963	942	817	879
	≤ 475 Bhn or ≤ 50 HRc	Slot 	1	≤ 0.4	98	RPM	10340	5170	3878	3102	2585	1939	1551
					(78-117)	Fz	0.012	0.029	0.049	0.061	0.072	0.083	0.112
						Feed (mm/min)	496	596	761	761	744	645	695
H TOOL STEELS A2, D2, H13, L2, M2, P20, S7, T15, W2	≤ 475 Bhn or ≤ 50 HRc	Profile 	≤ 0.4	≤ 1	64	RPM	6786	3393	2545	2036	1696	1272	1018
					(51-77)	Fz	0.010	0.024	0.041	0.051	0.060	0.068	0.093
						Feed (mm/min)	261	326	413	413	407	347	380
	≤ 655 Bhn or ≤ 60 HRc	Slot 	1	≤ 0.4	52	RPM	5493	2747	2060	1648	1373	1030	824
					(41-62)	Fz	0.010	0.024	0.041	0.051	0.060	0.068	0.093
						Feed (mm/min)	211	264	334	334	330	281	308
TOOL STEELS A2, D2, H13, L2, M2, P20, S7, T15, W2	≤ 655 Bhn or ≤ 60 HRc	Profile 	≤ 0.4	≤ 1	27	RPM	2908	1454	1091	872	727	545	436
					(22-33)	Fz	0.005	0.012	0.021	0.027	0.031	0.036	0.048
						Feed (mm/min)	56	70	93	93	91	79	84
TOOL STEELS A2, D2, H13, L2, M2, P20, S7, T15, W2	≤ 655 Bhn or ≤ 60 HRc	Slot 	1	≤ 0.4	21	RPM	2262	1131	848	679	565	424	339
					(17-26)	Fz	0.005	0.012	0.021	0.027	0.031	0.036	0.048
						Feed (mm/min)	43	54	72	72	71	62	65

Bhn (Brinell) HRc (Rockwell C)
 $rpm = (Vc \times 1000) / (DC \times 3.14)$
 $ipm = Fz \times 4 \times rpm$
 reduce speed and feed for materials harder than listed
 reduce feed and Ae when finish milling (.02 x DC maximum)
 feed rates listed have chip thinning adjustments included where applicable
 refer to the SGS Tool Wizard® for complete technical information (www.kyocera-sgstool.com)

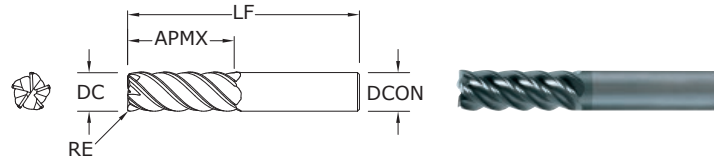
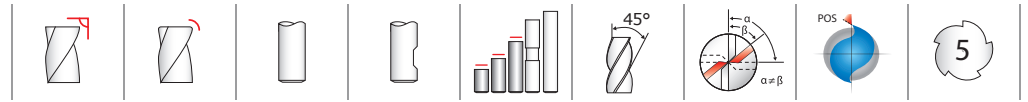

55 • 55CR FRACTIONAL SERIES

TOLERANCES (inch)

DC = +0.0000/-0.0020

DCON = h_6

RE = +0.0000/-0.0020

- STEELS
- STAINLESS STEELS
- CAST IRON
- HIGH TEMP ALLOYS
- TITANIUM
- HARDENED STEELS

For patent information visit www.ksptpatents.com

CUTTING DIAMETER DC	LENGTH OF CUT APMX	inch			EDP NO.	
		OVERALL LENGTH LF	SHANK DIAMETER DCON	CORNER RADIUS RE	Ti-NAMITE-A (AITIN)	Ti-NAMITE-A (AITIN) W/FLAT
1/8	1/4	1-1/2	1/8	—	32672	—
1/8	1/4	1-1/2	1/8	.010	32606	—
1/8	1/2	1-1/2	1/8	—	32655	—
1/8	1/2	1-1/2	1/8	.010	32607	—
5/32	5/16	2	3/16	.010	32608	—
5/32	9/16	2	3/16	—	32656	—
5/32	9/16	2	3/16	.010	32609	—
3/16	5/16	2	3/16	—	32673	—
3/16	5/16	2	3/16	.010	32610	—
3/16	5/8	2	3/16	—	32657	—
3/16	5/8	2	3/16	.010	32611	—
7/32	3/8	2	1/4	.015	32612	—
7/32	3/4	2-1/2	1/4	.015	32613	—
7/32	3/4	2-1/2	1/4	—	32658	—
1/4	3/8	2	1/4	.015	32614	—
1/4	3/8	2	1/4	—	32674	—
1/4	3/4	2-1/2	1/4	—	32659	—
1/4	3/4	2-1/2	1/4	.015	32615	—
1/4	1-1/4	4	1/4	.015	32616	—
5/16	7/16	2	5/16	—	32675	—
5/16	7/16	2	5/16	.015	32619	—
5/16	13/16	2-1/2	5/16	—	32660	—
5/16	13/16	2-1/2	5/16	.015	32620	—
5/16	1-1/4	4	5/16	.015	32621	—
3/8	1/2	2	3/8	—	32676	32677
3/8	1/2	2	3/8	.015	32625	32591
3/8	1/2	2	3/8	.030	32592	32593
3/8	1	2-1/2	3/8	—	32661	32662
3/8	1	2-1/2	3/8	.015	32626	32628
3/8	1	2-1/2	3/8	.030	32573	32574
3/8	1-1/2	4	3/8	.015	32627	—
3/8	1-1/2	4	3/8	.030	32569	—

continued on next page

- Unequal indexing, high helix and an ideal rake and relief combination for unmatched finishing capability
- The choice when peak finish quality is the requirement
- Enhanced corner geometry with tight tolerance corner radii
- Recommended for materials ≤ 45 HRc (≤ 420 Bhn)

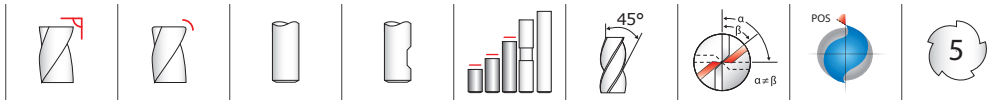

**55 •
55CR**
FRACTIONAL SERIES

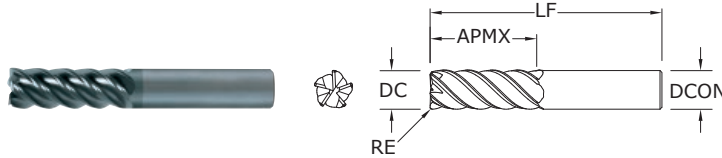

CONTINUED

CUTTING DIAMETER DC	LENGTH OF CUT APMX	inch			EDP NO.	
		OVERALL LENGTH LF	SHANK DIAMETER DCON	CORNER RADIUS RE	Ti-NAMITE-A (AITiN)	Ti-NAMITE-A (AITiN) W/FLAT
7/16	1	2-3/4	7/16	—	32663	—
7/16	1	2-3/4	7/16	.015	32632	—
7/16	2	4	7/16	.015	32633	—
1/2	5/8	2-1/2	1/2	—	32678	32679
1/2	5/8	2-1/2	1/2	.030	32594	32595
1/2	5/8	2-1/2	1/2	.060	32596	32597
1/2	1-1/4	3	1/2	—	32664	32665
1/2	1-1/4	3	1/2	.030	32575	32576
1/2	1-1/4	3	1/2	.060	32577	32578
1/2	2	4	1/2	.030	32685	—
1/2	2	4	1/2	.060	32686	—
5/8	3/4	3	5/8	—	32680	32681
5/8	3/4	3	5/8	.030	32598	32599
5/8	3/4	3	5/8	.060	32600	32601
5/8	1-5/8	3-1/2	5/8	—	32666	32667
5/8	1-5/8	3-1/2	5/8	.030	32579	32580
5/8	1-5/8	3-1/2	5/8	.060	32581	32582
5/8	2-1/2	5	5/8	.030	32570	—
5/8	2-1/2	5	5/8	.060	32687	—
3/4	1	3	3/4	.030	32602	32603
3/4	1	3	3/4	.060	32604	32605
3/4	1-5/8	4	3/4	—	32668	32669
3/4	1-5/8	4	3/4	.030	32583	32584
3/4	1-5/8	4	3/4	.060	32585	32586
3/4	3-1/4	6	3/4	.030	32571	—
3/4	3-1/4	6	3/4	.060	32688	—
1	1-1/2	4	1	—	32670	32671
1	1-1/2	4	1	.030	32587	32588
1	1-1/2	4	1	.060	32589	32590
1	2-5/8	6	1	.030	32572	—
1	2-5/8	6	1	.060	32689	—

TOLERANCES (inch)

DC = +0.0000/-0.0020
DCON = \pm .0006
RE = +0.0000/-0.0020

- STEELS
- STAINLESS STEELS
- CAST IRON
- HIGH TEMP ALLOYS
- TITANIUM
- HARDENED STEELS

For patent information visit www.ksptpatents.com

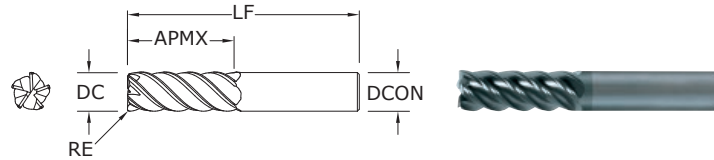
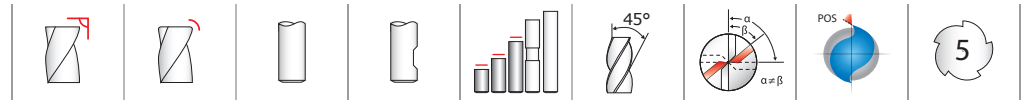

**55M •
55MCR**
METRIC SERIES

TOLERANCES (mm)

DC = +0,000/-0,050

DCON = h₆

RE = +0,000/-0,050

- STEELS
- STAINLESS STEELS
- CAST IRON
- HIGH TEMP ALLOYS
- TITANIUM
- HARDENED STEELS

For patent information visit www.ksptpatents.com

CUTTING DIAMETER DC	LENGTH OF CUT APMX	mm			EDP NO.	
		OVERALL LENGTH LF	SHANK DIAMETER DCON	CORNER RADIUS RE	Ti-NAMITE-A (AITIN)	Ti-NAMITE-A (AITIN) W/FLAT
6,0	12,0	50,0	6,0	—	42606	—
6,0	12,0	50,0	6,0	0,5	42660	—
6,0	19,0	63,0	6,0	—	42607	—
6,0	19,0	63,0	6,0	0,25	42661	—
6,0	19,0	63,0	6,0	0,5	42662	—
6,0	19,0	63,0	6,0	1,0	42663	—
6,0	19,0	63,0	6,0	1,5	42664	—
6,0	25,0	75,0	6,0	—	42608	—
6,0	25,0	75,0	6,0	0,5	42665	—
8,0	12,0	50,0	8,0	—	42609	—
8,0	12,0	50,0	8,0	0,5	42666	—
8,0	20,0	63,0	8,0	—	42610	—
8,0	20,0	63,0	8,0	0,5	42667	—
8,0	20,0	63,0	8,0	1,0	42668	—
8,0	20,0	63,0	8,0	1,5	42669	—
8,0	20,0	63,0	8,0	2,0	42670	—
8,0	25,0	75,0	8,0	—	42611	—
8,0	25,0	75,0	8,0	0,5	42671	—
10,0	16,0	50,0	10,0	—	42612	—
10,0	16,0	50,0	10,0	0,5	42672	—
10,0	22,0	75,0	10,0	—	42622	42613
10,0	22,0	75,0	10,0	0,5	42673	—
10,0	22,0	75,0	10,0	1,0	42674	—
10,0	22,0	75,0	10,0	1,5	42675	—
10,0	22,0	75,0	10,0	2,0	42676	—
10,0	22,0	75,0	10,0	2,5	42677	—
10,0	38,0	100,0	10,0	—	42614	—
10,0	38,0	100,0	10,0	0,5	42678	—
12,0	19,0	63,0	12,0	—	42615	—
12,0	19,0	63,0	12,0	0,5	42679	—
12,0	25,0	75,0	12,0	—	42616	42623
12,0	25,0	75,0	12,0	0,5	42680	—

continued on next page

- Unequal indexing, high helix and an ideal rake and relief combination for unmatched finishing capability
- The choice when peak finish quality is the requirement
- Enhanced corner geometry with tight tolerance corner radii
- Recommended for materials ≤ 45 HRC (≤ 420 Bhn)

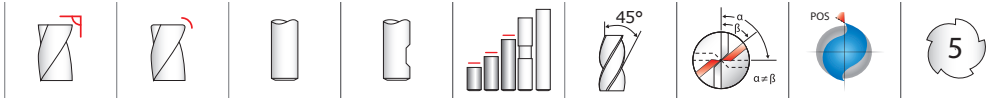

55M • 55MCR
METRIC SERIES

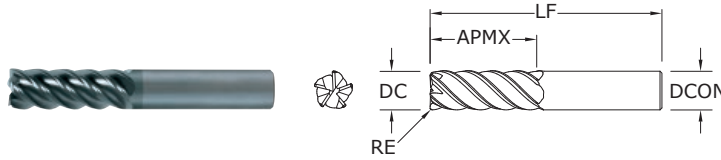

- Unequal indexing, high helix and an ideal rake and relief combination for unmatched finishing capability
- The choice when peak finish quality is the requirement
- Enhanced corner geometry with tight tolerance corner radii
- Recommended for materials ≤ 45 HRc (≤ 420 Bhn)

CUTTING DIAMETER DC	LENGTH OF CUT APMX	mm			EDP NO.	
		OVERALL LENGTH LF	SHANK DIAMETER DCON	CORNER RADIUS RE	Ti-NAMITE-A (AlTiN)	Ti-NAMITE-A (AlTiN) W/FLAT
12,0	25,0	75,0	12,0	1,0	42681	—
12,0	25,0	75,0	12,0	1,5	42682	—
12,0	25,0	75,0	12,0	2,0	42683	—
12,0	25,0	75,0	12,0	2,5	42684	—
12,0	25,0	75,0	12,0	3,0	42685	—
12,0	50,0	100,0	12,0	—	42617	—
12,0	50,0	100,0	12,0	0,5	42686	—
12,0	50,0	100,0	12,0	3,0	42630	—
12,0	50,0	100,0	12,0	4,0	42631	—
16,0	32,0	89,0	16,0	—	42618	42624
16,0	32,0	89,0	16,0	1,0	42687	—
16,0	32,0	89,0	16,0	1,5	42688	—
16,0	32,0	89,0	16,0	2,0	42689	—
16,0	32,0	89,0	16,0	2,5	42690	—
16,0	32,0	89,0	16,0	3,0	42691	—
16,0	32,0	89,0	16,0	4,0	42692	—
16,0	50,0	100,0	16,0	—	42626	—
16,0	50,0	100,0	16,0	2,0	42656	—
16,0	50,0	100,0	16,0	2,5	42657	—
16,0	50,0	100,0	16,0	3,0	42658	—
16,0	50,0	100,0	16,0	4,0	42659	—
16,0	50,0	100,0	16,0	5,0	42628	—
16,0	75,0	150,0	16,0	—	42619	—
16,0	75,0	150,0	16,0	1,0	42693	—
16,0	75,0	150,0	16,0	3,0	42632	—
16,0	75,0	150,0	16,0	4,0	42633	—
20,0	38,0	100,0	20,0	—	42620	42625
20,0	38,0	100,0	20,0	1,0	42694	—
20,0	38,0	100,0	20,0	1,5	42695	—
20,0	38,0	100,0	20,0	2,0	42696	—
20,0	38,0	100,0	20,0	2,5	42697	—
20,0	38,0	100,0	20,0	3,0	42698	—
20,0	38,0	100,0	20,0	4,0	42699	—
20,0	38,0	100,0	20,0	5,0	42700	—

TOLERANCES (mm)

DC = +0,000/-0,050
DCON = h_6
RE = +0,000/-0,050

- STEELS
- STAINLESS STEELS
- CAST IRON
- HIGH TEMP ALLOYS
- TITANIUM
- HARDENED STEELS

For patent information visit www.ksptpatents.com

continued on next page

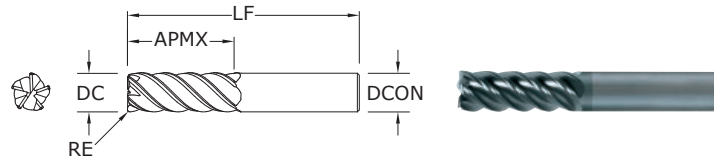
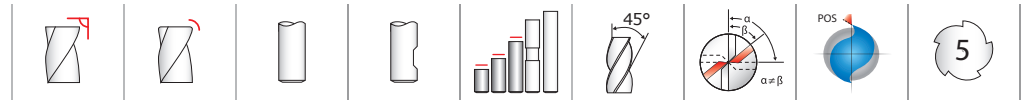

**55M •
55MCR**
METRIC SERIES

CONTINUED

TOLERANCES (mm)

DC = +0,000/-0,050

DCON = h_6

RE = +0,000/-0,050

- STEELS
- STAINLESS STEELS
- CAST IRON
- HIGH TEMP ALLOYS
- TITANIUM
- HARDENED STEELS

For patent information visit www.ksptpatents.com

CUTTING DIAMETER DC	LENGTH OF CUT APMX	mm			EDP NO.	
		OVERALL LENGTH LF	SHANK DIAMETER DCON	CORNER RADIUS RE	Ti-NAMITE-A (AITiN)	Ti-NAMITE-A (AITiN) W/FLAT
20,0	38,0	100,0	20,0	6,0	42648	—
20,0	50,0	100,0	20,0	—	42627	—
20,0	50,0	100,0	20,0	2,0	42649	—
20,0	50,0	100,0	20,0	2,5	42650	—
20,0	50,0	100,0	20,0	3,0	42651	—
20,0	50,0	100,0	20,0	4,0	42652	—
20,0	50,0	100,0	20,0	5,0	42653	—
20,0	50,0	100,0	20,0	6,0	42654	—
20,0	75,0	150,0	20,0	—	42621	—
20,0	75,0	150,0	20,0	1,0	42701	—
20,0	75,0	150,0	20,0	2,0	42702	—
20,0	75,0	150,0	20,0	3,0	42703	—
20,0	75,0	150,0	20,0	4,0	42704	—
20,0	75,0	150,0	20,0	5,0	42705	—
20,0	75,0	150,0	20,0	6,0	42655	—

V-Carb



55B

FRACTIONAL SERIES

- Unequal indexing, high helix and an ideal rake and relief combination for unmatched finishing capability
- The choice when peak finish quality is the requirement
- Ball nose design ideal for finishing operations in complex workpieces
- Recommended for materials ≤ 45 HRc (≤ 420 Bhn)

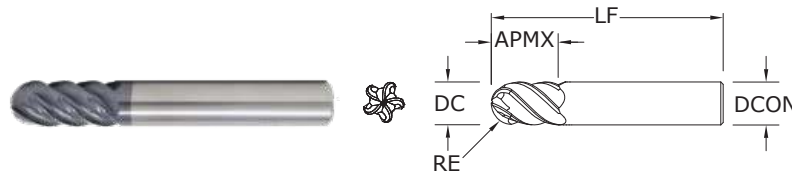

inch				EDP NO.
CUTTING DIAMETER DC	LENGTH OF CUT APMX	OVERALL LENGTH LF	SHANK DIAMETER DCON	Ti-NAMITE-A (AITiN)
1/4	3/4	2-1/2	1/4	32500
5/16	13/16	2-1/2	5/16	32501
3/8	1	2-1/2	3/8	32502
1/2	1-1/4	3	1/2	32503
5/8	1-5/8	3-1/2	5/8	32504
3/4	1-5/8	4	3/4	32505
1	1-1/2	4	1	32506

RE = 1/2 Cutting Diameter (DC)

TOLERANCES (inch)

DC = +0.0000/-0.0020
 DCON = h_6
 RE = +0.0005/-0.0010

- STEELS
- STAINLESS STEELS
- CAST IRON
- HIGH TEMP ALLOYS
- TITANIUM
- HARDENED STEELS

For patent information visit www.ksptpatents.com

55MB

METRIC SERIES

- Unequal indexing, high helix and an ideal rake and relief combination for unmatched finishing capability
- The choice when peak finish quality is the requirement
- Ball nose design ideal for finishing operations in complex workpieces
- Recommended for materials ≤ 45 HRc (≤ 420 Bhn)

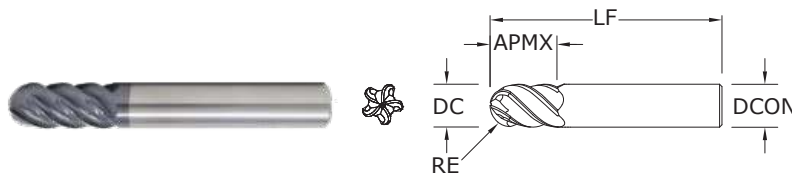

mm				EDP NO.
CUTTING DIAMETER DC	LENGTH OF CUT APMX	OVERALL LENGTH LF	SHANK DIAMETER DCON	Ti-NAMITE-A (AITiN)
6,0	13,0	57,0	6,0	42750
8,0	19,0	63,0	8,0	42751
10,0	22,0	72,0	10,0	42752
12,0	26,0	83,0	12,0	42753
16,0	32,0	92,0	16,0	42754
20,0	38,0	104,0	20,0	42755

RE = 1/2 Cutting Diameter (DC)

TOLERANCES (mm)

DC = +0,000/-0,050
 DCON = h_6
 RE = +0,000/-0,025

- STEELS
- STAINLESS STEELS
- CAST IRON
- HIGH TEMP ALLOYS
- TITANIUM
- HARDENED STEELS

For patent information visit www.ksptpatents.com

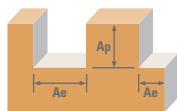

Series	Hardness	Ae x DC	Ap x DC	Vc (sfm)	DC • in									
					1/8	1/4	3/8	1/2	5/8	3/4	1			
Series 55, 55CR, 55B Fractional CARBON STEELS 1018, 1040, 1080, 1090, 10L50, 1140, 1212, 12L15, 1525, 1536 ALLOY STEELS 4140, 4150, 4320, 5120, 5150, 8630, 86L20, 50100	≤ 275 Bhn or ≤ 28 HRc	Profile 	≤ 0.25	≤ 1.5	385	RPM	11766	5883	3922	2941	2353	1961	1471	
					(308-462)	Fz	0.0004	0.0009	0.0017	0.0023	0.0029	0.0028	0.0032	
						Feed (ipm)	20.6	26.5	33.3	33.8	34.1	27.5	23.5	
		HSM 	≤ 0.05	≤ 2	630	RPM	19253	9626	6418	4813	3851	3209	2407	
					(504-756)	Fz	0.0007	0.0018	0.0034	0.0046	0.0057	0.0055	0.0064	
						Feed (ipm)	67.4	86.6	109.1	110.7	109.7	88.2	77.0	
	ALLOY STEELS 4140, 4150, 4320, 5120, 5150, 8630, 86L20, 50100	≤ 375 Bhn or ≤ 40 HRc	Profile 	≤ 0.25	≤ 1.5	325	RPM	9932	4966	3311	2483	1986	1655	1242
						(260-390)	Fz	0.0003	0.0007	0.0013	0.0017	0.0022	0.0021	0.0024
							Feed (ipm)	12.9	17.4	21.5	21.1	21.9	17.4	14.9
			HSM 	≤ 0.05	≤ 2	530	RPM	16197	8098	5399	4049	3239	2699	2025
						(424-636)	Fz	0.0005	0.0014	0.0026	0.0034	0.0043	0.0041	0.0048
							Feed (ipm)	42.1	56.7	70.2	68.8	69.6	55.3	48.6
STAINLESS STEELS (FREE MACHINING) 303, 416, 420F, 430F, 440F STAINLESS STEELS (DIFFICULT) 304, 304L, 316, 316L STAINLESS STEELS (PH) 13-8 PH, 15-5 PH, 17-4 PH, Custom 450	≤ 275 Bhn or ≤ 28 HRc	Profile 	≤ 0.25	≤ 1.5	370	RPM	11307	5654	3769	2827	2261	1885	1413	
					(296-444)	Fz	0.0003	0.0007	0.0013	0.0017	0.0022	0.0023	0.0024	
						Feed (ipm)	14.7	19.8	24.5	24.0	24.9	21.7	17.0	
		HSM 	≤ 0.05	≤ 2	560	RPM	17114	8557	5705	4278	3423	2852	2139	
					(448-672)	Fz	0.0005	0.0014	0.0026	0.0034	0.0043	0.0044	0.0048	
						Feed (ipm)	44.5	59.9	74.2	72.7	73.6	62.7	51.3	
	STAINLESS STEELS (DIFFICULT) 304, 304L, 316, 316L	≤ 275 Bhn or ≤ 28 HRc	Profile 	≤ 0.25	≤ 1.5	255	RPM	7793	3896	2598	1948	1559	1299	974
						(204-306)	Fz	0.0002	0.0006	0.0012	0.0016	0.0020	0.0021	0.0023
							Feed (ipm)	9.4	11.7	15.6	15.6	15.6	13.6	11.2
			HSM 	≤ 0.05	≤ 2	385	RPM	11766	5883	3922	2941	2353	1961	1471
						(308-462)	Fz	0.0005	0.0013	0.0024	0.0032	0.0040	0.0041	0.0045
							Feed (ipm)	28.2	38.2	47.1	47.1	47.1	40.2	33.1
STAINLESS STEELS (PH) 13-8 PH, 15-5 PH, 17-4 PH, Custom 450	≤ 325 Bhn or ≤ 35 HRc	Profile 	≤ 0.25	≤ 1.5	235	RPM	7182	3591	2394	1795	1436	1197	898	
					(188-282)	Fz	0.0002	0.0006	0.0010	0.0014	0.0017	0.0018	0.0019	
						Feed (ipm)	7.5	10.8	12.0	12.6	12.2	10.8	8.5	
		HSM 	≤ 0.05	≤ 2	355	RPM	10849	5424	3616	2712	2170	1808	1356	
					(284-426)	Fz	0.0004	0.0011	0.0021	0.0028	0.0034	0.0036	0.0039	
						Feed (ipm)	22.2	29.8	38.0	38.0	36.9	32.5	26.4	
CAST IRONS (LOW & MEDIUM ALLOY) Gray, Malleable, Ductile	≤ 220 Bhn or ≤ 19 HRc	Profile 	≤ 0.25	≤ 1.5	470	RPM	14363	7182	4788	3591	2873	2394	1795	
					(376-564)	Fz	0.0004	0.0009	0.0017	0.0023	0.0029	0.0030	0.0032	
						Feed (ipm)	25.1	32.3	40.7	41.3	41.7	35.9	28.7	
		HSM 	≤ 0.05	≤ 2	705	RPM	21545	10772	7182	5386	4309	3591	2693	
					(564-846)	Fz	0.0007	0.0018	0.0034	0.0046	0.0057	0.0059	0.0064	
						Feed (ipm)	75.4	97.0	122.1	123.9	122.8	105.9	86.2	

continued on next page

FRACTIONAL V-Carb

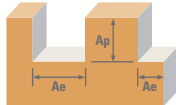

Series	Hardness	Ae x DC	Ap x DC	Vc (sfm)	DC • in								
					1/8	1/4	3/8	1/2	5/8	3/4	1		
K CAST IRONS (HIGH ALLOY) Gray, Malleable, Ductile	≤ 260 Bhn or ≤ 26 HRc	Profile 	≤ 0.25	≤ 1.5	360	RPM	11002	5501	3667	2750	2200	1834	1375
					(288-432)	Fz	0.0003	0.0007	0.0013	0.0017	0.0022	0.0023	0.0024
					Feed (ipm)	14.3	19.3	23.8	23.4	24.2	21.1	16.5	
		HSM 	≤ 0.05	≤ 2	540	RPM	16502	8251	5501	4126	3300	2750	2063
					(432-648)	Fz	0.0005	0.0014	0.0026	0.0034	0.0043	0.0044	0.0048
					Feed (ipm)	42.9	57.8	71.5	70.1	71.0	60.5	49.5	
S SUPER ALLOYS (NICKEL, COBALT, IRON BASE) Inconel 601, 617, 625, Incoloy, Monel 400	≤ 300 Bhn or ≤ 32 HRc	Profile 	≤ 0.25	≤ 1.5	70	RPM	2139	1070	713	535	428	357	267
					(56-84)	Fz	0.0002	0.0006	0.0010	0.0014	0.0017	0.0018	0.0019
					Feed (ipm)	2.2	3.2	3.6	3.7	3.6	3.2	2.5	
		HSM 	≤ 0.05	≤ 2	107	RPM	3270	1635	1090	817	654	545	409
					(86-128)	Fz	0.0004	0.0011	0.0021	0.0028	0.0034	0.0036	0.0039
					Feed (ipm)	6.7	9.0	11.4	11.4	11.1	9.8	8.0	
S SUPER ALLOYS (NICKEL, COBALT, IRON BASE) Inconel 718, X-750, Incoloy, Waspaloy, Hastelloy, Rene	≤ 400 Bhn or ≤ 43 HRc	Profile 	≤ 0.25	≤ 1.5	55	RPM	1681	840	560	420	336	280	210
					(44-66)	Fz	0.0002	0.0004	0.0008	0.0010	0.0013	0.0014	0.0015
					Feed (ipm)	1.3	1.7	2.2	2.1	2.2	2.0	1.6	
		HSM 	≤ 0.05	≤ 2	85	RPM	2598	1299	866	649	520	433	325
					(68-102)	Fz	0.0003	0.0008	0.0015	0.0021	0.0026	0.0027	0.0029
					Feed (ipm)	4.0	5.2	6.5	6.8	6.8	5.8	4.7	
S TITANIUM ALLOYS Pure Titanium, Ti6Al4V, Ti6Al2Sn4Zr2Mo, Ti4Al4Mo2Sn0.5Si	≤ 350 Bhn or ≤ 38 HRc	Profile 	≤ 0.25	≤ 1.5	235	RPM	7182	3591	2394	1795	1436	1197	898
					(188-282)	Fz	0.0002	0.0006	0.0012	0.0016	0.0020	0.0021	0.0023
					Feed (ipm)	7.2	10.8	14.4	14.4	14.4	12.6	10.3	
		HSM 	≤ 0.05	≤ 2	390	RPM	11918	5959	3973	2980	2384	1986	1490
					(312-468)	Fz	0.0005	0.0013	0.0024	0.0032	0.0040	0.0041	0.0045
					Feed (ipm)	29.8	38.7	47.7	47.7	47.7	40.7	33.5	
S TITANIUM ALLOYS (DIFFICULT) Ti10Al2Fe3Al, Ti5Al5V5Mo3Cr, Ti7Al4Mo, Ti3Al8V6Cr4Zr4Mo, Ti6Al6V6Sn, Ti15V3 Cr3Sn3Al	≤ 440 Bhn or ≤ 47 HRc	Profile 	≤ 0.25	≤ 1.5	85	RPM	2598	1299	866	649	520	433	325
					(68-102)	Fz	0.0002	0.0006	0.0012	0.0016	0.0020	0.0021	0.0023
					Feed (ipm)	2.6	3.9	5.2	5.2	5.2	4.5	3.7	
		HSM 	≤ 0.05	≤ 2	140	RPM	4278	2139	1426	1070	856	713	535
					(112-168)	Fz	0.0005	0.0013	0.0024	0.0032	0.0040	0.0042	0.0045
					Feed (ipm)	10.7	13.9	17.1	17.1	17.1	15.0	12.0	
H TOOL STEELS A2, D2, H13, L2, M2, P20, S7, T15, W2	≤ 375 Bhn or ≤ 40 HRc	Profile 	≤ 0.25	≤ 1.5	175	RPM	5348	2674	1783	1337	1070	891	669
					(140-210)	Fz	0.0002	0.0005	0.0010	0.0013	0.0016	0.0017	0.0018
					Feed (ipm)	5.3	6.7	8.9	8.7	8.6	7.6	6.0	
		HSM 	≤ 0.05	≤ 2	290	RPM	8862	4431	2954	2216	1772	1477	1108
					(232-348)	Fz	0.0004	0.0010	0.0019	0.0025	0.0032	0.0033	0.0035
					Feed (ipm)	17.7	22.2	28.1	27.7	28.4	24.4	19.4	

Bhn (Brinell) HRc (Rockwell C) HSM (High Speed Machining)
 rpm = Vc x 3.82 / DC
 ipm = Fz x 5 x rpm
 reduce speed and feed for materials harder than listed
 reduce feed and Ae when finish milling (.02 x DC maximum)
 reduce Ap to 1 x DC (maximum) when profile milling with long or extra long flute length tools
 feed rates listed have chip thinning adjustments included where applicable
 refer to the SGS Tool Wizard® for complete technical information (www.kyocera-sgstool.com)

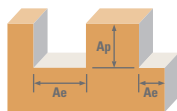





Series 55M, 55MCR, 55MB Metric	Hardness	Ae x DC	Ap x DC	Vc (m/min)	DC • mm							
					6	8	10	12	16	20		
P CARBON STEELS 1018, 1040, 1080, 1090, 10L50, 1140, 1212, 12L15, 1525, 1536	≤ 275 Bhn or ≤ 28 HRc	Profile 	≤ 0.25	≤ 1.5	117	RPM	6220	4665	3732	3110	2333	1866
					(94-141)	Fz	0.022	0.036	0.061	0.070	0.072	0.085
					Feed (mm/min)	672	846	1145	1082	836	796	
		HSM 	≤ 0.05	≤ 2	192	RPM	10179	7634	6107	5089	3817	3054
					(154-230)	Fz	0.043	0.073	0.123	0.137	0.141	0.154
					Feed (mm/min)	2198	2769	3746	3481	2687	2345	
	≤ 375 Bhn or ≤ 40 HRc	Profile 	≤ 0.25	≤ 1.5	99	RPM	5251	3938	3151	2626	1969	1575
					(79-119)	Fz	0.017	0.028	0.045	0.053	0.054	0.064
					Feed (mm/min)	441	546	571	693	529	504	
		HSM 	≤ 0.05	≤ 2	162	RPM	8563	6422	5138	4282	3211	2569
					(129-194)	Fz	0.034	0.055	0.091	0.103	0.105	0.128
					Feed (mm/min)	1438	1781	2329	2209	1685	1644	
M STAINLESS STEELS (FREE MACHINING) 303, 416, 420F, 430F, 440F	≤ 275 Bhn or ≤ 28 HRc	Profile 	≤ 0.25	≤ 1.5	113	RPM	5978	4484	3587	2989	2242	1793
					(90-135)	Fz	0.017	0.028	0.045	0.053	0.059	0.064
					Feed (mm/min)	502	622	813	789	660	574	
		HSM 	≤ 0.05	≤ 2	171	RPM	9048	6786	5429	4524	3393	2714
					(137-205)	Fz	0.034	0.055	0.091	0.103	0.113	0.128
					Feed (mm/min)	1520	1882	2461	2334	1911	1737	
	≤ 275 Bhn or ≤ 28 HRc	Profile 	≤ 0.25	≤ 1.5	78	RPM	4120	3090	2472	2060	1545	1236
					(62-93)	Fz	0.014	0.026	0.043	0.048	0.054	0.061
					Feed (mm/min)	297	396	527	494	415	379	
		HSM 	≤ 0.05	≤ 2	117	RPM	6220	4665	3732	3110	2333	1866
					(94-141)	Fz	0.031	0.051	0.085	0.096	0.105	0.120
					Feed (mm/min)	970	1194	1592	1493	1224	1120	
≤ 325 Bhn or ≤ 35 HRc	Profile 	≤ 0.25	≤ 1.5	72	RPM	3797	2848	2278	1898	1424	1139	
				(57-86)	Fz	0.014	0.021	0.037	0.041	0.046	0.051	
				Feed (mm/min)	273	304	425	387	328	289		
	HSM 	≤ 0.05	≤ 2	108	RPM	5736	4302	3441	2868	2151	1721	
				(87-130)	Fz	0.026	0.045	0.075	0.082	0.092	0.104	
				Feed (mm/min)	757	964	1285	1170	991	895		

continued on next page

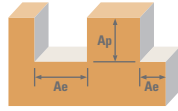
METRIC V-Carb

Series
55M, 55MCR,
55MB
Metric



Metric	Hardness	Ae x DC	Ap x DC	Vc (m/min)	DC • mm								
					6	8	10	12	16	20			
K	CAST IRONS (LOW & MEDIUM ALLOY) Gray, Malleable, Ductile	≤ 220 Bhn or ≤ 19 HRc	Profile 	≤ 0.25	≤ 1.5	143	RPM	7594	5695	4556	3797	2848	2278
						(115-172)	Fz	0.022	0.036	0.061	0.070	0.077	0.085
							Feed (mm/min)	820	1033	1397	1321	1093	972
						215	RPM	11391	8543	6834	5695	4271	3417
						(172-258)	Fz	0.043	0.073	0.123	0.137	0.151	0.171
							Feed (mm/min)	2460	3099	4192	3895	3226	2916
	CAST IRONS (HIGH ALLOY) Gray, Malleable, Ductile	≤ 260 Bhn or ≤ 26 HRc	Profile 	≤ 0.25	≤ 1.5	110	RPM	5816	4362	3490	2908	2181	1745
						(88-132)	Fz	0.017	0.028	0.045	0.053	0.059	0.064
							Feed (mm/min)	489	605	791	768	642	558
						165	RPM	8725	6544	5235	4362	3272	2617
						(132-198)	Fz	0.034	0.055	0.091	0.103	0.113	0.128
							Feed (mm/min)	1466	1815	2373	2251	1843	1675
S	SUPER ALLOYS (NICKEL, COBALT, IRON BASE) Inconel 601, 617, 625, Incoloy, Monel 400	≤ 300 Bhn or ≤ 32 HRc	Profile 	≤ 0.25	≤ 1.5	21	RPM	1131	848	679	565	424	339
						(17-26)	Fz	0.014	0.021	0.037	0.041	0.046	0.051
							Feed (mm/min)	81	90	127	115	98	86
						33	RPM	1729	1297	1037	864	648	519
						(26-39)	Fz	0.026	0.045	0.075	0.082	0.092	0.104
							Feed (mm/min)	228	290	387	353	299	270
	SUPER ALLOYS (NICKEL, COBALT, IRON BASE) Inconel 718, X-750, Incoloy, Waspaloy, Hastelloy, Rene	≤ 400 Bhn or ≤ 43 HRc	Profile 	≤ 0.25	≤ 1.5	17	RPM	889	666	533	444	333	267
						(13-20)	Fz	0.010	0.017	0.027	0.031	0.036	0.040
							Feed (mm/min)	43	57	71	69	60	53
						26	RPM	1373	1030	824	687	515	412
						(21-31)	Fz	0.019	0.032	0.056	0.062	0.069	0.077
							Feed (mm/min)	132	165	231	214	178	159

continued on next page

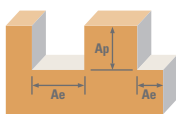

Series	Hardness	Ae x DC	Ap x DC	Vc (m/min)	DC • mm									
					6	8	10	12	16	20				
S TITANIUM ALLOYS Pure Titanium, Ti6Al4V, Ti6Al2Sn4Zr2Mo, Ti4Al4Mo2Sn0.5Si	≤ 350 Bhn or ≤ 38 HRc	Profile 	≤ 0.25	≤ 1.5	72	RPM	3797	2848	2278	1898	1424	1139		
					(57-86)	Fz	0.014	0.026	0.043	0.048	0.054	0.061		
					Feed (mm/min)	273	365	486	456	383	349			
					HSM 	119	RPM	6301	4726	3781	3151	2363	1890	
						(95-143)	Fz	0.031	0.051	0.085	0.096	0.105	0.120	
						Feed (mm/min)	983	1210	1613	1512	1240	1134		
	TITANIUM ALLOYS (DIFFICULT) Ti10Al2Fe3Al, Ti5Al5V5Mo3Cr, Ti7Al4Mo, Ti3Al8V6Cr4Zr4Mo, Ti6Al6V6Sn, Ti15V3 Cr3Sn3Al	≤ 440 Bhn or ≤ 47 HRc	Profile 	≤ 0.25	≤ 1.5	26	RPM	1373	1030	824	687	515	412	
						(21-31)	Fz	0.014	0.026	0.043	0.048	0.054	0.061	
						Feed (mm/min)	99	132	176	165	138	126		
						HSM 	43	RPM	2262	1696	1357	1131	848	679
							(34-51)	Fz	0.031	0.051	0.085	0.096	0.108	0.120
							Feed (mm/min)	353	434	579	543	456	407	
H TOOL STEELS A2, D2, H13, L2, M2, P20, S7, T15, W2	≤ 375 Bhn or ≤ 40 HRc	Profile 	≤ 0.25	≤ 1.5	53	RPM	2827	2121	1696	1414	1060	848		
					(43-64)	Fz	0.012	0.021	0.035	0.038	0.044	0.048		
					Feed (mm/min)	170	226	294	271	231	204			
					HSM 	88	RPM	4686	3514	2811	2343	1757	1406	
						(71-106)	Fz	0.024	0.041	0.067	0.077	0.084	0.093	
						Feed (mm/min)	562	712	937	900	742	656		

Bhn (Brinell) HRc (Rockwell C) HSM (High Speed Machining)
 $rpm = (Vc \times 1000) / (DC \times 3.14)$
 $mm/min = Fz \times 5 \times rpm$
 reduce speed and feed for materials harder than listed
 reduce feed and Ae when finish milling (.02 x DC maximum)
 reduce Ap to 1 x DC (maximum) when profile milling with long or extra long flute length tools
 feed rates listed have chip thinning adjustments included where applicable
 refer to the SGS Tool Wizard® for complete technical information (www.kyocera-sgstool.com)

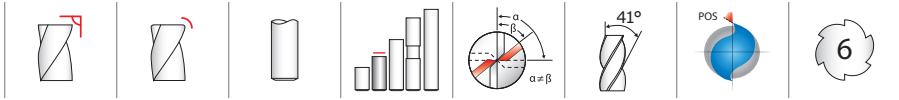

**51 •
51CR**
FRACTIONAL SERIES

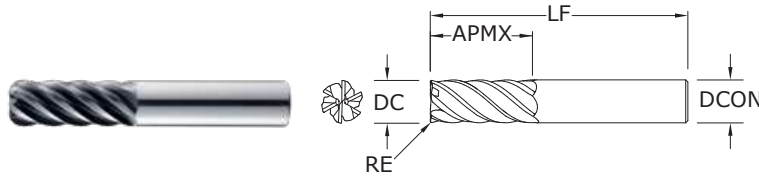

- Engineered for High Speed Milling using Trochoidal and Peel Milling techniques
- Eccentric relief provides superior strength and smoother surface finish
- Enhanced corner geometry with tight tolerance corner radii
- Recommended for materials ≤ 45 HRc (≤ 420 Bhn)

CUTTING DIAMETER DC	LENGTH OF CUT APMX	inch			CORNER RADIUS RE	EDP NO. TI-NAMITE-X (TX)
		OVERALL LENGTH LF	SHANK DIAMETER DCON			
1/4	3/4	2-1/2	1/4	—	35100	
1/4	3/4	2-1/2	1/4	.015	35112	
1/4	3/4	2-1/2	1/4	.030	35150	
3/8	1	2-1/2	3/8	—	35101	
3/8	1	2-1/2	3/8	.015	35113	
3/8	1	2-1/2	3/8	.030	35114	
1/2	1-1/4	3	1/2	—	35102	
1/2	1-1/4	3	1/2	.015	35151	
1/2	1-1/4	3	1/2	.030	35115	
1/2	1-1/4	3	1/2	.060	35152	
1/2	1-1/4	3	1/2	.090	35116	
1/2	1-1/4	3	1/2	.120	35117	
5/8	1-5/8	3-1/2	5/8	—	35103	
5/8	1-5/8	3-1/2	5/8	.015	35153	
5/8	1-5/8	3-1/2	5/8	.030	35118	
5/8	1-5/8	3-1/2	5/8	.060	35154	
5/8	1-5/8	3-1/2	5/8	.090	35119	
5/8	1-5/8	3-1/2	5/8	.120	35120	
5/8	1-5/8	3-1/2	5/8	.190	35155	
3/4	1-5/8	4	3/4	—	35104	
3/4	1-5/8	4	3/4	.030	35121	
3/4	1-5/8	4	3/4	.060	35156	
3/4	1-5/8	4	3/4	.090	35122	
3/4	1-5/8	4	3/4	.120	35123	
3/4	1-5/8	4	3/4	.190	35157	
3/4	1-5/8	4	3/4	.250	35158	
1	2-5/8	6	1	—	35105	
1	2-5/8	6	1	.030	35124	
1	2-5/8	6	1	.060	35159	
1	2-5/8	6	1	.090	35125	
1	2-5/8	6	1	.120	35126	
1	2-5/8	6	1	.190	35160	
1	2-5/8	6	1	.250	35161	

TOLERANCES (inch)

- DC = +0.0000/-0.0020
- DCON = H_6
- RE = +0.0000/-0.0020

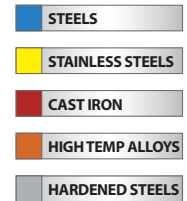

For patent information visit www.kspatents.com

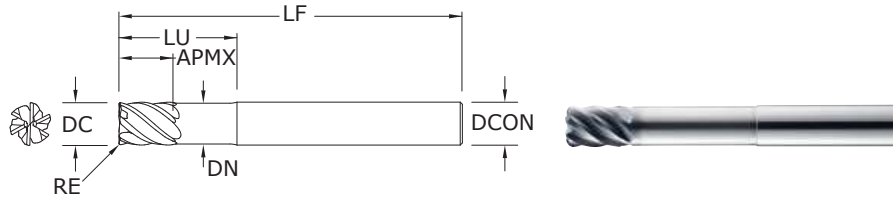
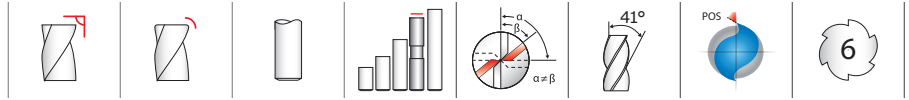

**51L •
51LC**
FRACTIONAL SERIES

TOLERANCES (inch)

DC = +0.0000/-0.0020
 DCON = h₆
 RE = +0.0000/-0.0020

- STEELS
- STAINLESS STEELS
- HIGH TEMP ALLOYS
- TITANIUM
- HARDENED STEELS

For patent information visit www.kspatents.com

CUTTING DIAMETER DC	LENGTH OF CUT APMX	OVERALL LENGTH LF	inch				CORNER RADIUS RE	EDP NO. TI-NAMITE-X (TX)
			SHANK DIAMETER DCON	REACH LU	NECK DIAMETER DN			
1/4	3/8	4	1/4	1-1/8	.237	—	35106	
1/4	3/8	4	1/4	1-1/8	.237	.015	35127	
1/4	3/8	4	1/4	1-1/8	.237	.030	35180	
3/8	1/2	4	3/8	2-1/8	.356	—	35107	
3/8	1/2	4	3/8	2-1/8	.356	.015	35128	
3/8	1/2	4	3/8	2-1/8	.356	.030	35129	
1/2	5/8	4	1/2	2-1/4	.475	—	35108	
1/2	5/8	4	1/2	2-1/4	.475	.015	35181	
1/2	5/8	4	1/2	2-1/4	.475	.030	35130	
1/2	5/8	4	1/2	2-1/4	.475	.060	35182	
1/2	5/8	4	1/2	2-1/4	.475	.090	35131	
1/2	5/8	4	1/2	2-1/4	.475	.120	35132	
5/8	3/4	5	5/8	2-1/2	.594	—	35109	
5/8	3/4	5	5/8	2-1/2	.594	.015	35183	
5/8	3/4	5	5/8	2-1/2	.594	.030	35133	
5/8	3/4	5	5/8	2-1/2	.594	.060	35184	
5/8	3/4	5	5/8	2-1/2	.594	.090	35134	
5/8	3/4	5	5/8	2-1/2	.594	.120	35135	
5/8	3/4	5	5/8	2-1/2	.594	.190	35185	
3/4	1	6	3/4	3-3/8	.712	—	35110	
3/4	1	6	3/4	3-3/8	.712	.030	35136	
3/4	1	6	3/4	3-3/8	.712	.060	35186	
3/4	1	6	3/4	3-3/8	.712	.090	35137	
3/4	1	6	3/4	3-3/8	.712	.120	35138	
3/4	1	6	3/4	3-3/8	.712	.190	35187	
3/4	1	6	3/4	3-3/8	.712	.250	35188	
1	1-1/4	6	1	3-3/8	.950	—	35111	
1	1-1/4	6	1	3-3/8	.950	.030	35139	
1	1-1/4	6	1	3-3/8	.950	.060	35189	
1	1-1/4	6	1	3-3/8	.950	.090	35140	
1	1-1/4	6	1	3-3/8	.950	.120	35141	
1	1-1/4	6	1	3-3/8	.950	.190	35190	
1	1-1/4	6	1	3-3/8	.950	.250	35191	

- Engineered for High Speed Milling using Trochoidal and Peel Milling techniques
- Eccentric relief provides superior strength and smoother surface finish
- Necked design with blended diameter transitions provide clearance to reach
- Enhanced corner geometry with tight tolerance corner radii
- Recommended for materials ≤ 45 HRC (≤ 420 Bhn)

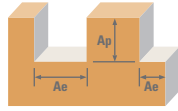

Series
51, 51CR, 51L,
51LC

Fractional	Hardness	Ae x DC	Ap x DC	Vc (sfm)	DC • in							
					1/4	3/8	1/2	5/8	3/4	1		
P	CARBON STEELS 1018, 1040, 1080, 1090, 10L50, 1140, 1212, 12L15, 1525, 1536	Profile 	≤ 0.1	≤ 1	720	RPM	11002	7334	5501	4401	3667	2750
					(576-864)	Fz	0.0020	0.0035	0.0050	0.0055	0.0061	0.0071
					Feed (ipm)	132	154	165	145	134	117	
		HSM 	≤ 0.05	≤ 2	915	RPM	13981	9321	6991	5592	4660	3495
					(732-1098)	Fz	0.0028	0.0053	0.0070	0.0077	0.0085	0.0100
					Feed (ipm)	235	296	294	258	238	210	
	ALLOY STEELS 4140, 4150, 4320, 5120, 5150, 8630, 86L20, 50100	Profile 	≤ 0.1	≤ 1	490	RPM	7487	4991	3744	2995	2496	1872
					(392-588)	Fz	0.0015	0.0029	0.0038	0.0042	0.0046	0.0054
					Feed (ipm)	67	87	85	75	69	61	
		HSM 	≤ 0.05	≤ 2	620	RPM	9474	6316	4737	3789	3158	2368
					(496-744)	Fz	0.0021	0.0039	0.0052	0.0057	0.0062	0.0073
					Feed (ipm)	119	148	148	130	117	104	
M	STAINLESS STEELS (FREE MACHINING) 303, 416, 420F, 430F, 440F	Profile 	≤ 0.1	≤ 1	510	RPM	7793	5195	3896	3117	2598	1948
					(459-561)	Fz	0.0015	0.0028	0.0038	0.0041	0.0045	0.0053
					Feed (ipm)	70	87	89	77	70	62	
		HSM 	≤ 0.05	≤ 2	650	RPM	9932	6621	4966	3973	3311	2483
					(585-715)	Fz	0.0021	0.0038	0.0051	0.0056	0.0061	0.0072
					Feed (ipm)	125	151	152	133	121	107	
	STAINLESS STEELS (DIFFICULT) 304, 304L, 316, 316L	Profile 	≤ 0.1	≤ 1	350	RPM	5348	3565	2674	2139	1783	1337
					(315-385)	Fz	0.0012	0.0023	0.0030	0.0033	0.0036	0.0042
					Feed (ipm)	39	49	48	42	39	34	
		HSM 	≤ 0.05	≤ 2	450	RPM	6876	4584	3438	2750	2292	1719
					(405-495)	Fz	0.0017	0.0032	0.0042	0.0046	0.0050	0.0059
					Feed (ipm)	70	88	87	76	69	61	
STAINLESS STEELS (PH) 13-8 PH, 15-5 PH, 17-4 PH, Custom 450	Profile 	≤ 0.1	≤ 1	325	RPM	4966	3311	2483	1986	1655	1242	
				(293-358)	Fz	0.0012	0.0023	0.0030	0.0033	0.0036	0.0042	
				Feed (ipm)	36	46	45	39	36	31		
	HSM 	≤ 0.05	≤ 2	410	RPM	6265	4177	3132	2506	2088	1566	
				(369-451)	Fz	0.0017	0.0032	0.0042	0.0046	0.0050	0.0059	
				Feed (ipm)	64	80	79	69	63	55		

continued on next page

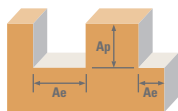

Series	Hardness	Profile	Ae x DC	Ap x DC	Vc (sfm)	DC • in							
						1/4	3/8	1/2	5/8	3/4	1		
S SUPER ALLOYS (NICKEL, COBALT, IRON BASE) Inconel 601, 617, 625, Incoloy, Monel 400	≤ 300 Bhn or ≤ 32 HRc	Profile 	≤ 0.1	≤ 1	105	RPM	1604	1070	802	642	535	401	
					(84-126)	Fz	0.0014	0.0027	0.0036	0.0039	0.0043	0.0050	
					Feed (ipm)	13	17	17	15	14	12		
		HSM 	≤ 0.05	≤ 2	130	RPM	1986	1324	993	795	662	497	
					(104-156)	Fz	0.0016	0.0036	0.0048	0.0053	0.0058	0.0067	
					Feed (ipm)	19	29	29	25	23	20		
	SUPER ALLOYS (NICKEL, COBALT, IRON BASE) Inconel 718, X-750, Incoloy, Waspaloy, Hastelloy, Rene	≤ 400 Bhn or ≤ 43 HRc	Profile 	≤ 0.1	≤ 1	80	RPM	1222	815	611	489	407	306
						(64-96)	Fz	0.0010	0.0018	0.0025	0.0027	0.0029	0.0034
						Feed (ipm)	7	9	9	8	7	6	
			HSM 	≤ 0.05	≤ 2	100	RPM	1528	1019	764	611	509	382
						(80-120)	Fz	0.0013	0.0025	0.0034	0.0037	0.0041	0.0047
						Feed (ipm)	12	15	16	14	13	11	
TITANIUM ALLOYS Pure Titanium, Ti6Al4V, Ti6Al2Sn4Zr2Mo, Ti4Al4Mo2Sn0.5Si	≤ 350 Bhn or ≤ 38 HRc	Profile 	≤ 0.1	≤ 1	280	RPM	4278	2852	2139	1711	1426	1070	
					(224-336)	Fz	0.0010	0.0018	0.0025	0.0027	0.0029	0.0034	
					Feed (ipm)	26	31	32	28	25	22		
		HSM 	≤ 0.05	≤ 2	355	RPM	5424	3616	2712	2170	1808	1356	
					(284-426)	Fz	0.0013	0.0025	0.0034	0.0037	0.0041	0.0047	
					Feed (ipm)	42	54	55	48	44	38		
TITANIUM ALLOYS (DIFFICULT) Ti10Al2Fe3Al, Ti5Al5V5Mo3Cr, Ti7Al4Mo, Ti3Al8V6Cr4Zr4Mo, Ti6Al6V6Sn, Ti15V3 Cr3Sn3Al	≤ 440 Bhn or ≤ 47 HRc	Profile 	≤ 0.1	≤ 1	155	RPM	2368	1579	1184	947	789	592	
					(124-186)	Fz	0.0010	0.0018	0.0025	0.0027	0.0029	0.0034	
					Feed (ipm)	14	17	18	15	14	12		
		HSM 	≤ 0.05	≤ 2	200	RPM	3056	2037	1528	1222	1019	764	
					(160-240)	Fz	0.0013	0.0025	0.0034	0.0037	0.0041	0.0047	
					Feed (ipm)	24	31	31	27	25	22		
H TOOL STEELS A2, D2, H13, L2, M2, P20, S7, T15, W2	≤ 375 Bhn or ≤ 40 HRc	Profile 	≤ 0.1	≤ 1	240	RPM	3667	2445	1834	1467	1222	917	
					(192-288)	Fz	0.0012	0.0023	0.0030	0.0034	0.0037	0.0043	
					Feed (ipm)	26	34	33	30	27	24		
		HSM 	≤ 0.05	≤ 2	305	RPM	4660	3107	2330	1864	1553	1165	
					(244-366)	Fz	0.0017	0.0032	0.0042	0.0046	0.0050	0.0059	
					Feed (ipm)	48	60	59	51	47	41		

Bhn (Brinell) HRc (Rockwell C) HSM (High Speed Machining)
 rpm = Vc x 3.82 / DC
 ipm = Fz x 6 x rpm
 reduce speed and feed for materials harder than listed
 reduce feed and Ae when finish milling (.02 x DC maximum)
 feed rates listed have chip thinning adjustments included where applicable
 refer to the SGS Tool Wizard® for complete technical information (www.kyocera-sgstool.com)

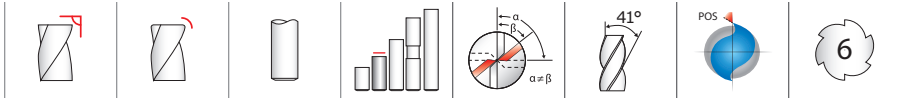

**51M •
51MCR**
METRIC SERIES

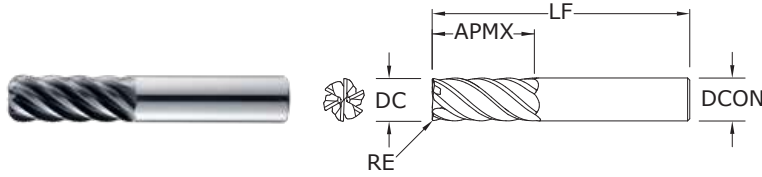

- Engineered for High Speed Milling using Trochoidal and Peel Milling techniques
- Eccentric relief provides superior strength and smoother surface finish
- Enhanced corner geometry with tight tolerance corner radii
- Recommended for materials ≤ 45 HRc (≤ 420 Bhn)

mm					EDP NO.
CUTTING DIAMETER DC	LENGTH OF CUT APMX	OVERALL LENGTH LF	SHANK DIAMETER DCON	CORNER RADIUS RE	TI-NAMITE-X (TX)
6,0	19,0	63,0	6,0	—	45100
6,0	19,0	63,0	6,0	0,5	45112
6,0	19,0	63,0	6,0	1,0	45170
6,0	19,0	63,0	6,0	1,5	45171
8,0	20,0	63,0	8,0	—	45101
8,0	20,0	63,0	8,0	0,5	45113
8,0	20,0	63,0	8,0	1,0	45114
8,0	20,0	63,0	8,0	1,2	45150
8,0	20,0	63,0	8,0	1,5	45172
8,0	20,0	63,0	8,0	2,0	45173
10,0	22,0	75,0	10,0	—	45102
10,0	22,0	75,0	10,0	0,5	45174
10,0	22,0	75,0	10,0	1,0	45115
10,0	22,0	75,0	10,0	1,5	45116
10,0	22,0	75,0	10,0	2,0	45117
10,0	22,0	75,0	10,0	2,5	45175
12,0	26,0	83,0	12,0	—	45103
12,0	26,0	83,0	12,0	0,5	45176
12,0	26,0	83,0	12,0	0,76	45177
12,0	26,0	83,0	12,0	1,0	45118
12,0	26,0	83,0	12,0	1,5	45119
12,0	26,0	83,0	12,0	2,0	45120
12,0	26,0	83,0	12,0	2,5	45178
12,0	26,0	83,0	12,0	3,0	45179
16,0	32,0	92,0	16,0	—	45104
16,0	32,0	92,0	16,0	1,0	45121
16,0	32,0	92,0	16,0	1,5	45122
16,0	32,0	92,0	16,0	2,0	45123
16,0	32,0	92,0	16,0	2,5	45180
16,0	32,0	92,0	16,0	3,0	45181
16,0	32,0	92,0	16,0	4,0	45182
20,0	38,0	104,0	20,0	—	45105
20,0	38,0	104,0	20,0	1,0	45124
20,0	38,0	104,0	20,0	1,5	45125
20,0	38,0	104,0	20,0	2,0	45126
20,0	38,0	104,0	20,0	2,5	45183
20,0	38,0	104,0	20,0	3,0	45184
20,0	38,0	104,0	20,0	4,0	45185
20,0	38,0	104,0	20,0	5,0	45186

TOLERANCES (mm)

DC = +0,000/-0,050
 DCON = h_6
 RE = +0,000/-0,050

- STEELS
- STAINLESS STEELS
- HIGH TEMP ALLOYS
- TITANIUM
- HARDENED STEELS

For patent information visit www.kspatents.com

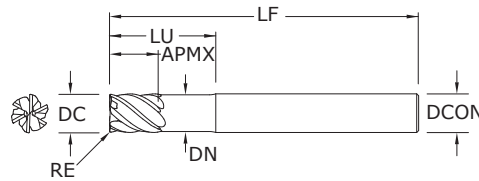
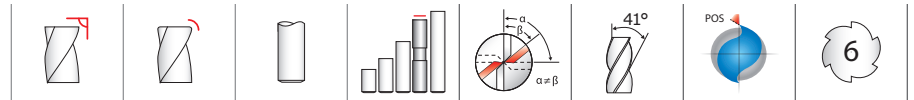

**51ML •
51MLC**
METRIC SERIES

TOLERANCES (mm)

DC = +0,000/-0,050
DCON = h₆
RE = +0,000/-0,050

- STEELS
- STAINLESS STEELS
- HIGH TEMP ALLOYS
- TITANIUM
- HARDENED STEELS









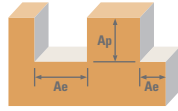

For patent information visit www.ksptpatents.com

mm							EDP NO.
CUTTING DIAMETER DC	LENGTH OF CUT APMX	OVERALL LENGTH LF	SHANK DIAMETER DCON	REACH LU	NECK DIAMETER DN	CORNER RADIUS RE	TI-NAMITE-X (TX)
6,0	8,0	75,0	6,0	32,0	5,69	—	45106
6,0	8,0	75,0	6,0	32,0	5,69	0,5	45127
6,0	8,0	75,0	6,0	32,0	5,69	1,0	45187
6,0	8,0	75,0	6,0	32,0	5,69	1,5	45188
8,0	10,0	75,0	8,0	32,0	7,59	—	45107
8,0	10,0	75,0	8,0	32,0	7,59	0,5	45128
8,0	10,0	75,0	8,0	32,0	7,59	1,0	45129
8,0	10,0	75,0	8,0	32,0	7,59	1,5	45189
8,0	10,0	75,0	8,0	32,0	7,59	2,0	45190
10,0	12,0	100,0	10,0	40,0	9,50	—	45108
10,0	12,0	100,0	10,0	40,0	9,50	0,5	45191
10,0	12,0	100,0	10,0	40,0	9,50	1,0	45130
10,0	12,0	100,0	10,0	40,0	9,50	1,5	45131
10,0	12,0	100,0	10,0	40,0	9,50	2,0	45132
10,0	12,0	100,0	10,0	40,0	9,50	2,5	45192
12,0	15,0	100,0	12,0	48,0	11,38	—	45109
12,0	15,0	100,0	12,0	48,0	11,38	0,5	45193
12,0	15,0	100,0	12,0	48,0	11,38	0,76	45194
12,0	15,0	100,0	12,0	48,0	11,38	1,0	45133
12,0	15,0	100,0	12,0	48,0	11,38	1,5	45134
12,0	15,0	100,0	12,0	48,0	11,38	2,0	45135
12,0	15,0	100,0	12,0	48,0	11,38	2,5	45195
12,0	15,0	100,0	12,0	48,0	11,38	3,0	45196
16,0	20,0	115,0	16,0	65,0	15,19	—	45110
16,0	20,0	115,0	16,0	65,0	15,19	1,0	45136
16,0	20,0	115,0	16,0	65,0	15,19	1,5	45137
16,0	20,0	115,0	16,0	65,0	15,19	2,0	45138
16,0	20,0	115,0	16,0	65,0	15,19	2,5	45197
16,0	20,0	115,0	16,0	65,0	15,19	3,0	45198
16,0	20,0	115,0	16,0	65,0	15,19	4,0	45199
20,0	24,0	150,0	20,0	80,0	19,00	—	45111
20,0	24,0	150,0	20,0	80,0	19,00	1,0	45139
20,0	24,0	150,0	20,0	80,0	19,00	1,5	45140
20,0	24,0	150,0	20,0	80,0	19,00	2,0	45141
20,0	24,0	150,0	20,0	80,0	19,00	2,5	45200
20,0	24,0	150,0	20,0	80,0	19,00	3,0	45201
20,0	24,0	150,0	20,0	80,0	19,00	4,0	45202
20,0	24,0	150,0	20,0	80,0	19,00	5,0	45203

- Engineered for High Speed Milling using Trochoidal and Peel Milling techniques
- Eccentric relief provides superior strength and smoother surface finish
- Necked design with blended diameter transitions provide clearance to reach
- Enhanced corner geometry with tight tolerance corner radii
- Recommended for materials ≤ 45 HRc (≤ 420 Bhn)

Series
51M, 51MCR,
51ML, 51MLC
Metric



	Hardness	Ae x DC	Ap x DC	Vc (m/min)	DC • mm							
					6	8	10	12	16	20		
P	CARBON STEELS 1018, 1040, 1080, 1090, 10L50, 1140, 1212, 12L15, 1525, 1536	Profile 	≤ 0.1	≤ 1	219	RPM	11633	8725	6980	5816	4362	3490
					(176-263)	Fz	0.048	0.081	0.101	0.121	0.142	0.158
					Feed (mm/min)	3350	4240	4230	4223	3717	3308	
		HSM 	≤ 0.05	≤ 2	279	RPM	14784	11088	8870	7392	5544	4435
					(223-335)	Fz	0.066	0.113	0.141	0.169	0.197	0.220
					Feed (mm/min)	5854	7517	7504	7495	6553	5854	
	ALLOY STEELS 4140, 4150, 4320, 5120, 5150, 8630, 86L20, 50100	Profile 	≤ 0.1	≤ 1	149	RPM	7917	5938	4750	3958	2969	2375
					(119-179)	Fz	0.036	0.061	0.077	0.092	0.107	0.119
					Feed (mm/min)	1710	2173	2195	2185	1906	1696	
		HSM 	≤ 0.05	≤ 2	189	RPM	10017	7513	6010	5009	3756	3005
					(151-227)	Fz	0.049	0.083	0.104	0.125	0.146	0.163
					Feed (mm/min)	2945	3741	3750	3756	3291	2939	
M	STAINLESS STEELS (FREE MACHINING) 303, 416, 420F, 430F, 440F	Profile 	≤ 0.1	≤ 1	155	RPM	8240	6180	4944	4120	3090	2472
					(140-171)	Fz	0.035	0.060	0.075	0.090	0.105	0.117
					Feed (mm/min)	1730	2225	2225	2225	1947	1735	
		HSM 	≤ 0.05	≤ 2	198	RPM	10502	7877	6301	5251	3938	3151
					(178-218)	Fz	0.048	0.082	0.102	0.122	0.143	0.159
					Feed (mm/min)	3025	3875	3856	3844	3379	3006	
	STAINLESS STEELS (DIFFICULT) 304, 304L, 316, 316L	Profile 	≤ 0.1	≤ 1	107	RPM	5655	4241	3393	2827	2121	1696
					(96-117)	Fz	0.029	0.049	0.061	0.073	0.086	0.096
					Feed (mm/min)	984	1247	1242	1238	1094	977	
		HSM 	≤ 0.05	≤ 2	137	RPM	7271	5453	4362	3635	2726	2181
					(123-151)	Fz	0.040	0.069	0.086	0.103	0.120	0.134
					Feed (mm/min)	1745	2258	2251	2247	1963	1754	
STAINLESS STEELS (PH) 13-8 PH, 15-5 PH, 17-4 PH, Custom 450	Profile 	≤ 0.1	≤ 1	99	RPM	5251	3938	3151	2626	1969	1575	
				(89-109)	Fz	0.029	0.049	0.061	0.073	0.086	0.096	
				Feed (mm/min)	914	1158	1153	1150	1016	907		
	HSM 	≤ 0.05	≤ 2	125	RPM	6624	4968	3975	3312	2484	1987	
				(112-137)	Fz	0.040	0.069	0.086	0.103	0.120	0.134	
				Feed (mm/min)	1590	2057	2051	2047	1789	1598		

continued on next page

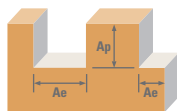

Series 51M, 51MCR, 51ML, 51MLC Metric	Hardness	Ae x DC	Ap x DC	Vc (m/min)	DC • mm							
					6	8	10	12	16	20		
SUPER ALLOYS (NICKEL, COBALT, IRON BASE) Inconel 601, 617, 625, Incoloy, Monel 400	≤ 300 Bhn or ≤ 32 HRc	Profile 	≤ 0.1	≤ 1	32	RPM	1696	1272	1018	848	636	509
					(26-38)	Fz	0.034	0.057	0.071	0.085	0.100	0.110
					Feed (mm/min)	346	435	434	433	382	336	
		HSM 	≤ 0.05	≤ 2	40	RPM	2100	1575	1260	1050	788	630
					(32-48)	Fz	0.046	0.077	0.097	0.120	0.140	0.150
					Feed (mm/min)	580	728	733	756	662	567	
	≤ 400 Bhn or ≤ 43 HRc	Profile 	≤ 0.1	≤ 1	24	RPM	1293	969	776	646	485	388
					(20-29)	Fz	0.023	0.039	0.049	0.059	0.068	0.077
					Feed (mm/min)	178	227	228	229	198	179	
		HSM 	≤ 0.05	≤ 2	30	RPM	1616	1212	969	808	606	485
					(24-37)	Fz	0.032	0.054	0.068	0.081	0.095	0.110
					Feed (mm/min)	310	393	396	393	345	320	
TITANIUM ALLOYS Pure Titanium, Ti6Al4V, Ti6Al2Sn4Zr2Mo, Ti4Al4Mo2Sn0.5Si	≤ 350 Bhn or ≤ 38 HRc	Profile 	≤ 0.1	≤ 1	85	RPM	4524	3393	2714	2262	1696	1357
					(68-102)	Fz	0.023	0.039	0.049	0.059	0.068	0.077
					Feed (mm/min)	624	794	798	801	692	627	
		HSM 	≤ 0.05	≤ 2	108	RPM	5736	4302	3441	2868	2151	1721
					(87-130)	Fz	0.032	0.054	0.068	0.081	0.095	0.110
					Feed (mm/min)	1101	1394	1404	1394	1226	1136	
	≤ 440 Bhn or ≤ 47 HRc	Profile 	≤ 0.1	≤ 1	47	RPM	2504	1878	1503	1252	939	751
					(38-57)	Fz	0.023	0.039	0.049	0.059	0.068	0.077
					Feed (mm/min)	346	440	442	443	383	347	
		HSM 	≤ 0.05	≤ 2	61	RPM	3231	2424	1939	1616	1212	969
					(49-73)	Fz	0.032	0.054	0.068	0.081	0.095	0.110
					Feed (mm/min)	620	785	791	785	691	640	
TOOL STEELS A2, D2, H13, L2, M2, P20, S7, T15, W2	≤ 375 Bhn or ≤ 40 HRc	Profile 	≤ 0.1	≤ 1	73	RPM	3878	2908	2327	1939	1454	1163
					(59-88)	Fz	0.029	0.049	0.061	0.073	0.086	0.096
					Feed (mm/min)	675	855	852	849	750	670	
	HSM 	≤ 0.05	≤ 2	93	RPM	4928	3696	2957	2464	1848	1478	
				(74-112)	Fz	0.040	0.069	0.086	0.103	0.120	0.134	
				Feed (mm/min)	1183	1530	1526	1523	1331	1189		

Bhn (Brinell) HRc (Rockwell C) HSM (High Speed Machining)
 $rpm = (Vc \times 1000) / (DC \times 3.14)$
 $mm/min = Fz \times 6 \times rpm$
 reduce speed and feed for materials harder than listed
 reduce feed and Ae when finish milling (.02 x DC maximum)
 feed rates listed have chip thinning adjustments included where applicable
 refer to the SGS Tool Wizard® for complete technical information (www.kyocera-sgstool.com)



**77 •
77CR**
FRACTIONAL SERIES

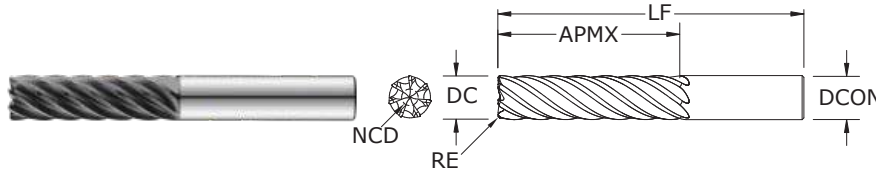

- Specializes in deep axial trochoidal and high-speed milling applications
- Optimized core improves rigidity, chip flow and reduces deflection
- Chip Breaker design breaks up chips from the long flute length allowing for better chip flow and evacuation in deep pocketing operations
- Recommended for materials ≤ 45 HRc (≤ 420 Bhn)

inch						EDP NO.			
CUTTING DIAMETER DC	LENGTH OF CUT APMX	OVERALL LENGTH LF	SHANK DIAMETER DCON	CORNER RADIUS RE	NON-CUTTING CENTER DIAMETER NCD	TI-NAMITE-A (TA) EDP NO.	TI-NAMITE-A (TA) CHIP BREAKER EDP NO.	TI-NAMITE-M (TM) EDP NO.	TI-NAMITE-M (TM) CHIP BREAKER EDP NO.
1/4	5/8	2-1/2	1/4	-	0.0845	77100	77102	77101	77103
1/4	5/8	2-1/2	1/4	.015	0.0845	77104	77106	77105	77107
1/4	5/8	2-1/2	1/4	.030	0.0845	77108	77110	77109	77111
1/4	3/4	2-1/2	1/4	-	0.0845	77112	77114	77113	77115
1/4	3/4	2-1/2	1/4	.015	0.0845	77116	77118	77117	77119
1/4	3/4	2-1/2	1/4	.030	0.0845	77120	77122	77121	77123
1/4	1	3	1/4	-	0.0845	77124	77126	77125	77127
1/4	1	3	1/4	.015	0.0845	77128	77130	77129	77131
1/4	1	3	1/4	.030	0.0845	77132	77134	77133	77135
3/8	15/16	3	3/8	-	0.1268	77136	77138	77137	77139
3/8	15/16	3	3/8	.015	0.1268	77140	77142	77141	77143
3/8	15/16	3	3/8	.030	0.1268	77144	77146	77145	77147
3/8	1-1/8	3-1/4	3/8	-	0.1268	77148	77150	77149	77151
3/8	1-1/8	3-1/4	3/8	.015	0.1268	77152	77154	77153	77155
3/8	1-1/8	3-1/4	3/8	.030	0.1268	77156	77158	77157	77159
3/8	1-1/2	3-1/2	3/8	-	0.1268	77160	77162	77161	77163
3/8	1-1/2	3-1/2	3/8	.015	0.1268	77164	77166	77165	77167
3/8	1-1/2	3-1/2	3/8	.030	0.1268	77168	77170	77169	77171
1/2	1-1/4	3-1/4	1/2	-	0.1690	77172	77174	77173	77175
1/2	1-1/4	3-1/4	1/2	.030	0.1690	77176	77178	77177	77179
1/2	1-1/4	3-1/4	1/2	.060	0.1690	77180	77182	77181	77183
1/2	1-1/2	3-1/2	1/2	-	0.1690	77184	77186	77185	77187
1/2	1-1/2	3-1/2	1/2	.030	0.1690	77188	77190	77189	77191
1/2	1-1/2	3-1/2	1/2	.060	0.1690	77192	77194	77193	77195
1/2	2	4	1/2	-	0.1690	77196	77198	77197	77199
1/2	2	4	1/2	.030	0.1690	77200	77202	77201	77203
1/2	2	4	1/2	.060	0.1690	77204	77206	77205	77207
5/8	1-9/16	3-3/4	5/8	-	0.2113	77208	77210	77209	77211
5/8	1-9/16	3-3/4	5/8	.030	0.2113	77212	77214	77213	77215
5/8	1-9/16	3-3/4	5/8	.060	0.2113	77216	77218	77217	77219

TOLERANCES (inch)

- 1/8-1/4 DIAMETER**
 DC = +0.0000/-0.0012
 DCON = h_6
 RE = +0.000/-0.002
- >1/4-3/8 DIAMETER**
 DC = +0.0000/-0.0016
 DCON = h_6
 RE = +0.000/-0.002
- >3/8-1 DIAMETER**
 DC = +0.0000/-0.0020
 DCON = h_6
 RE = +0.000/-0.002

- STEELS
- STAINLESS STEELS
- CAST IRON
- HIGH TEMP ALLOYS
- TITANIUM
- NON-FERROUS
- HARDENED STEELS

For patent information visit www.ksptpatents.com

continued on next page

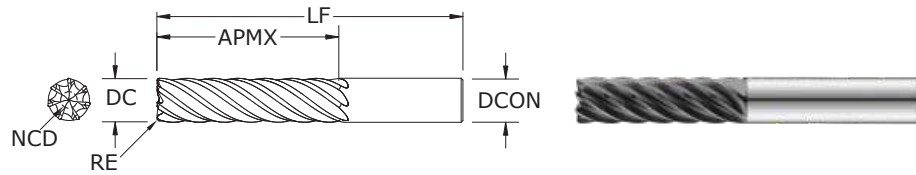

**77 •
77CR**
FRACTIONAL SERIES

TOLERANCES (inch)

1/8–1/4 DIAMETER

DC = +0.0000/-0.0012

DCON = h_6

RE = +0.000 / -0.002

>1/4–3/8 DIAMETER

DC = +0.0000/-0.0016

DCON = h_6

RE = +0.000 / -0.002

>3/8–1 DIAMETER

DC = +0.0000/-0.0020

DCON = h_6

RE = +0.000 / -0.002

- STEELS
- STAINLESS STEELS
- CAST IRON
- HIGH TEMP ALLOYS
- TITANIUM
- NON-FERROUS
- HARDENED STEELS

For patent information visit www.ksptpatents.com

inch						EDP NO.			
CUTTING DIAMETER DC	LENGTH OF CUT APMX	OVERALL LENGTH LF	SHANK DIAMETER DCON	CORNER RADIUS RE	NON-CUTTING CENTER DIAMETER NCD	TI-NAMITE-A (TA) EDP NO.	TI-NAMITE-A (TA) CHIP BREAKER EDP NO.	TI-NAMITE-M (TM) EDP NO.	TI-NAMITE-M (TM) CHIP BREAKER EDP NO.
5/8	1-7/8	4	5/8	—	0.2113	77220	77222	77221	77223
5/8	1-7/8	4	5/8	.030	0.2113	77224	77226	77225	77227
5/8	1-7/8	4	5/8	.060	0.2113	77228	77230	77229	77231
5/8	2-1/2	4-1/2	5/8	—	0.2113	77232	77234	77233	77235
5/8	2-1/2	4-1/2	5/8	.030	0.2113	77236	77238	77237	77239
5/8	2-1/2	4-1/2	5/8	.060	0.2113	77240	77242	77241	77243
3/4	1-7/8	4	3/4	—	0.2535	77244	77246	77245	77247
3/4	1-7/8	4	3/4	.030	0.2113	77248	77250	77249	77251
3/4	1-7/8	4	3/4	.060	0.2113	77252	77254	77253	77255
3/4	1-7/8	4	3/4	.120	0.2113	77256	77258	77257	77259
3/4	2-1/4	4-1/2	3/4	—	0.2535	77260	77262	77261	77263
3/4	2-1/4	4-1/2	3/4	.030	0.2535	77264	77266	77265	77267
3/4	2-1/4	4-1/2	3/4	.060	0.2535	77268	77270	77269	77271
3/4	2-1/4	4-1/2	3/4	.120	0.2535	77272	77274	77273	77275
3/4	3	5-1/4	3/4	—	0.2535	77276	77278	77277	77279
3/4	3	5-1/4	3/4	.030	0.2535	77280	77282	77281	77283
3/4	3	5-1/4	3/4	.060	0.2535	77284	77286	77285	77287
3/4	3	5-1/4	3/4	.120	0.2535	77288	77290	77289	77291
1	2-1/2	5-1/2	1	—	0.3380	77292	77294	77293	77295
1	2-1/2	5-1/2	1	.030	0.3380	77296	77298	77297	77299
1	2-1/2	5-1/2	1	.060	0.3380	77300	77302	77301	77303
1	2-1/2	5-1/2	1	.120	0.3380	77304	77306	77305	77307
1	3	6	1	—	0.3380	77308	77310	77309	77311
1	3	6	1	.030	0.3380	77312	77314	77313	77315
1	3	6	1	.060	0.3380	77316	77318	77317	77319
1	3	6	1	.120	0.3380	77320	77322	77321	77323
1	4	7	1	—	0.3380	77324	77326	77325	77327
1	4	7	1	.030	0.3380	77328	77330	77329	77331
1	4	7	1	.060	0.3380	77332	77334	77333	77335
1	4	7	1	.120	0.3380	77336	77338	77337	77339

CONTINUED



**77M •
77MCR**
METRIC SERIES

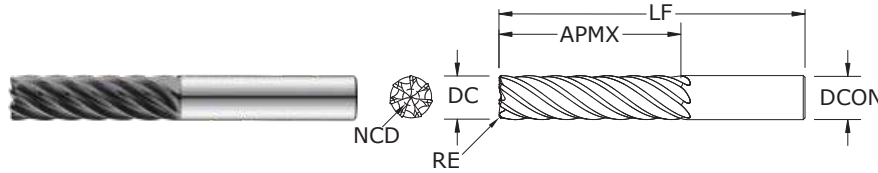

- Specializes in deep axial trochoidal and high-speed milling applications
- Optimized core improves rigidity, chip flow and reduces deflection
- Chip Breaker design breaks up chips from the long flute length allowing for better chip flow and evacuation in deep pocketing operations
- Recommended for materials ≤ 45 HRc (≤ 420 Bhn)

mm						EDP NO.			
CUTTING DIAMETER DC	LENGTH OF CUT APMX	OVERALL LENGTH LF	SHANK DIAMETER DCON	CORNER RADIUS RE	NON-CUTTING CENTER DIAMETER NCD	TI-NAMITE-A (TA) EDP NO.	TI-NAMITE-A (TA) CHIP BREAKER EDP NO.	TI-NAMITE-M (TM) EDP NO.	TI-NAMITE-M (TM) CHIP BREAKER EDP NO.
6,0	15,0	63,0	6,0	–	2,03	74300	74302	74301	74303
6,0	15,0	63,0	6,0	0,3	2,03	74304	74306	74305	74307
6,0	15,0	63,0	6,0	0,5	2,03	74308	74310	74309	74311
6,0	18,0	63,0	6,0	–	2,03	74316	74318	74317	74319
6,0	18,0	63,0	6,0	0,3	2,03	74320	74322	74321	74323
6,0	18,0	63,0	6,0	0,5	2,03	74324	74326	74325	74327
6,0	24,0	75,0	6,0	–	2,03	74332	74334	74333	74335
6,0	24,0	75,0	6,0	0,3	2,03	74336	74338	74337	74339
6,0	24,0	75,0	6,0	0,5	2,03	74340	74342	74341	74343
8,0	20,0	75,0	8,0	–	2,71	74348	74350	74349	74351
8,0	20,0	75,0	8,0	0,5	2,71	74352	74354	74353	74355
8,0	20,0	75,0	8,0	1,0	2,71	74356	74358	74357	74359
8,0	20,0	75,0	8,0	2,0	2,71	74360	74362	74361	74363
8,0	24,0	75,0	8,0	–	2,71	74364	74366	74365	74367
8,0	24,0	75,0	8,0	0,5	2,71	74368	74370	74369	74371
8,0	24,0	75,0	8,0	1,0	2,71	74372	74374	74373	74375
8,0	24,0	75,0	8,0	2,0	2,71	74376	74378	74377	74379
8,0	32,0	85,0	8,0	–	2,71	74380	74382	74381	74383
8,0	32,0	85,0	8,0	0,5	2,71	74384	74386	74385	74387
8,0	32,0	85,0	8,0	1,0	2,71	74388	74390	74389	74391
8,0	32,0	85,0	8,0	2,0	2,71	74392	74394	74393	74395
10,0	25,0	75,0	10,0	–	3,38	74396	74398	74397	74399
10,0	25,0	75,0	10,0	0,5	3,38	74400	74402	74401	74403
10,0	25,0	75,0	10,0	1,0	3,38	74404	74406	74405	74407
10,0	30,0	80,0	10,0	–	3,38	74408	74410	74409	74411
10,0	30,0	80,0	10,0	0,5	3,38	74412	74414	74413	74415
10,0	30,0	80,0	10,0	1,0	3,38	74416	74418	74417	74419
10,0	40,0	100,0	10,0	–	3,38	74420	74422	74421	74423
10,0	40,0	100,0	10,0	0,5	3,38	74424	74426	74425	74427
10,0	40,0	100,0	10,0	1,0	3,38	74428	74430	74429	74431
12,0	30,0	83,0	12,0	–	4,06	74432	74434	74433	74435
12,0	30,0	83,0	12,0	0,5	4,06	74436	74438	74437	74439
12,0	30,0	83,0	12,0	1,0	4,06	74440	74442	74441	74443
12,0	36,0	83,0	12,0	–	4,06	74444	74446	74445	74447
12,0	36,0	83,0	12,0	0,5	4,06	74448	74450	74449	74451
12,0	36,0	83,0	12,0	1,0	4,06	74452	74454	74453	74455

TOLERANCES (mm)

- 6 DIAMETER**
 DC = +0,000/-0,030
 DCON = h_6
 RE = +0,000 / -0,050
- >6-10 DIAMETER**
 DC = +0,000/-0,040
 DCON = h_6
 RE = +0,000 / -0,050
- >10-25 DIAMETER**
 DC = +0,000/-0,050
 DCON = h_6
 RE = +0,000 / -0,050

- STEELS
- STAINLESS STEELS
- CAST IRON
- HIGH TEMP ALLOYS
- TITANIUM
- NON-FERROUS
- HARDENED STEELS

For patent information visit www.ksptpatents.com

continued on next page

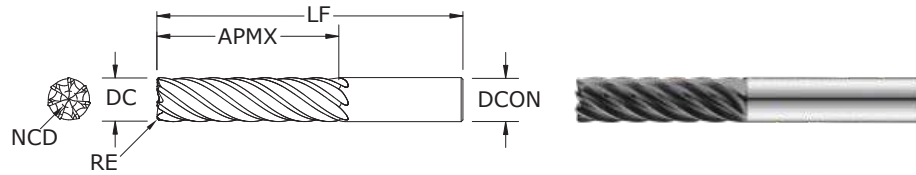

**77M •
77MCR**
METRIC SERIES

TOLERANCES (mm)

6 DIAMETER

DC = +0,000/-0,030
DCON = h₆
RE = +0,000 / -0,050

>6-10 DIAMETER

DC = +0,000/-0,040
DCON = h₆
RE = +0,000 / -0,050

>10-25 DIAMETER

DC = +0,000/-0,050
DCON = h₆
RE = +0,000 / -0,050

- STEELS
- STAINLESS STEELS
- CAST IRON
- HIGH TEMP ALLOYS
- TITANIUM
- NON-FERROUS
- HARDENED STEELS

For patent information visit www.kspatents.com

mm						EDP NO.			
CUTTING DIAMETER DC	LENGTH OF CUT APMX	OVERALL LENGTH LF	SHANK DIAMETER DCON	CORNER RADIUS RE	NON-CUTTING CENTER DIAMETER NCD	TI-NAMITE-A (TA) EDP NO.	TI-NAMITE-A (TA) CHIP BREAKER EDP NO.	TI-NAMITE-M (TM) EDP NO.	TI-NAMITE-M (TM) CHIP BREAKER EDP NO.
12,0	48,0	100,0	12,0	—	4,06	74456	74458	74457	74459
12,0	48,0	100,0	12,0	0,5	4,06	74460	74462	74461	74463
12,0	48,0	100,0	12,0	1,0	4,06	74464	74466	74465	74467
16,0	40,0	92,0	16,0	—	5,41	74468	74470	74469	74471
16,0	40,0	92,0	16,0	0,5	5,41	74472	74474	74473	74475
16,0	40,0	92,0	16,0	1,0	5,41	74476	74478	74477	74479
16,0	48,0	100,0	16,0	—	5,41	74480	74482	74481	74483
16,0	48,0	100,0	16,0	0,5	5,41	74484	74486	74485	74487
16,0	48,0	100,0	16,0	1,0	5,41	74488	74490	74489	74491
16,0	64,0	115,0	16,0	—	5,41	74492	74494	74493	74495
16,0	64,0	115,0	16,0	0,5	5,41	74496	74498	74497	74499
16,0	64,0	115,0	16,0	1,0	5,41	74500	74502	74501	74503
20,0	50,0	100,0	20,0	—	6,76	74504	74506	74505	74507
20,0	50,0	100,0	20,0	0,5	6,76	74508	74510	74509	74511
20,0	50,0	100,0	20,0	1,0	6,76	74512	74514	74513	74515
20,0	50,0	100,0	20,0	2,0	6,76	74516	74518	74517	74519
20,0	60,0	115,0	20,0	—	6,76	74520	74522	74521	74523
20,0	60,0	115,0	20,0	0,5	6,76	74524	74526	74525	74527
20,0	60,0	115,0	20,0	1,0	6,76	74528	74530	74529	74531
20,0	60,0	115,0	20,0	2,0	6,76	74532	74534	74533	74535
20,0	80,0	140,0	20,0	—	6,76	74536	74538	74537	74539
20,0	80,0	140,0	20,0	0,5	6,76	74540	74542	74541	74543
20,0	80,0	140,0	20,0	1,0	6,76	74544	74546	74545	74547
20,0	80,0	140,0	20,0	2,0	6,76	74548	74550	74549	74551
25,0	63,0	135,0	25,0	—	8,45	74552	74554	74553	74555
25,0	63,0	135,0	25,0	1,0	8,45	74556	74558	74557	74559
25,0	63,0	135,0	25,0	2,0	8,45	74560	74562	74561	74563
25,0	63,0	135,0	25,0	3,0	8,45	74564	74566	74565	74567
25,0	75,0	150,0	25,0	—	8,45	74568	74570	74569	74571
25,0	75,0	150,0	25,0	1,0	8,45	74572	74574	74573	74575
25,0	75,0	150,0	25,0	2,0	8,45	74576	74578	74577	74579
25,0	75,0	150,0	25,0	3,0	8,45	74580	74582	74581	74583
25,0	100,0	170,0	25,0	—	8,45	74584	74586	74585	74587
25,0	100,0	170,0	25,0	1,0	8,45	74588	74590	74589	74591
25,0	100,0	170,0	25,0	2,0	8,45	74592	74594	74593	74595
25,0	100,0	170,0	25,0	3,0	8,45	74596	74598	74597	74599

CONTINUED

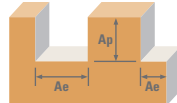

Series 77, 77CR Fractional	Hardness	Ae x D ₁	Ap x D ₁	Vc (sfm)	D ₁ • inch						
					1/4	3/8	1/2	5/8	3/4	1	
P CARBON STEELS 1018, 1040, 1080, 1090, 10L50, 1140, 1212, 12L15, 1525, 1536	≤ 275 Bhn or ≤ 28 HRc	HSM	2.5xD	816	RPM	11552	7701	5776	4621	3851	2888
			≤ 0.2 ≤ APMX (653-979)	Fz	0.0015	0.0024	0.0031	0.0035	0.0038	0.0042	
		HSM	3xD	845	Feed (ipm)	121	129	125	113	102	85
			≤ 0.15 ≤ APMX (676-1014)	Fz	0.0017	0.0027	0.0035	0.0040	0.0043	0.0047	
		HSM	4xD	756	Feed (ipm)	136	146	140	129	116	95
			≤ 0.1 ≤ APMX (605-907)	Fz	0.0018	0.0028	0.0036	0.0041	0.0044	0.0049	
	≤ 375 Bhn or ≤ 40 HRc	HSM	2.5xD	595	RPM	8419	5613	4210	3368	2806	2105
			≤ 0.2 ≤ APMX (476-714)	Fz	0.0009	0.0019	0.0026	0.0028	0.0031	0.0035	
		HSM	3xD	616	Feed (ipm)	53	75	77	66	61	52
			≤ 0.15 ≤ APMX (493-739)	Fz	0.0010	0.0021	0.0030	0.0033	0.0035	0.0039	
		HSM	4xD	551	Feed (ipm)	59	83	88	78	69	57
			≤ 0.1 ≤ APMX (441-661)	Fz	0.0011	0.0022	0.0031	0.0034	0.0036	0.0041	
M STAINLESS STEELS (FREE MACHINING) 303, 416, 420F, 430F, 440F	≤ 275 Bhn or ≤ 28 HRc	HSM	2.5xD	646	RPM	9137	6092	4569	3655	3046	2284
			≤ 0.2 ≤ APMX (517-775)	Fz	0.0009	0.0017	0.0023	0.0025	0.0028	0.0032	
		HSM	3xD	669	Feed (ipm)	58	72	74	64	60	51
			≤ 0.15 ≤ APMX (535-803)	Fz	0.0010	0.0019	0.0026	0.0029	0.0031	0.0036	
		HSM	4xD	598	Feed (ipm)	64	81	83	74	66	58
			≤ 0.1 ≤ APMX (478-718)	Fz	0.0011	0.0020	0.0027	0.0030	0.0033	0.0037	
	≤ 275 Bhn or ≤ 28 HRc	HSM	2.5xD	425	RPM	6020	4014	3010	2408	2007	1505
			≤ 0.2 ≤ APMX (340-510)	Fz	0.0007	0.0014	0.0019	0.0023	0.0026	0.0030	
		HSM	3xD	440	Feed (ipm)	29	39	40	39	37	32
			≤ 0.15 ≤ APMX (352-528)	Fz	0.0008	0.0016	0.0021	0.0025	0.0029	0.0034	
		HSM	4xD	394	Feed (ipm)	34	45	44	42	41	36
			≤ 0.1 ≤ APMX (315-473)	Fz	0.0008	0.0016	0.0022	0.0026	0.0030	0.0035	
≤ 325 Bhn or ≤ 35 HRc	HSM	2.5xD	408	RPM	5776	3851	2888	2310	1925	1444	
		≤ 0.2 ≤ APMX (326-490)	Fz	0.0007	0.0014	0.0019	0.0023	0.0026	0.0030		
	HSM	3xD	422	Feed (ipm)	28	38	38	37	35	30	
		≤ 0.15 ≤ APMX (338-506)	Fz	0.0008	0.0016	0.0021	0.0025	0.0029	0.0034		
	HSM	4xD	378	Feed (ipm)	32	43	42	40	39	34	
		≤ 0.1 ≤ APMX (302-454)	Fz	0.0008	0.0016	0.0022	0.0026	0.0030	0.0035		
P CAST IRONS (LOW & MEDIUM ALLOY) Gray, Malleable, Ductile	≤ 220 Bhn or ≤ 19 HRc	HSM	2.5xD	714	RPM	10100	6733	5050	4040	3367	2525
			≤ 0.2 ≤ APMX (571-857)	Fz	0.0010	0.0018	0.0024	0.0028	0.0033	0.0037	
		HSM	3xD	739	Feed (ipm)	71	85	85	79	78	65
			≤ 0.15 ≤ APMX (591-887)	Fz	0.0011	0.0020	0.0027	0.0033	0.0037	0.0042	
		HSM	4xD	661	Feed (ipm)	78	94	95	93	87	73
			≤ 0.1 ≤ APMX (529-793)	Fz	0.0012	0.0021	0.0028	0.0034	0.0039	0.0043	
	≤ 260 Bhn or ≤ 26 HRc	HSM	2.5xD	425	RPM	6020	4014	3010	2408	2007	1505
			≤ 0.2 ≤ APMX (340-510)	Fz	0.0007	0.0014	0.0019	0.0023	0.0026	0.0030	
		HSM	3xD	440	Feed (ipm)	29	39	40	39	37	32
			≤ 0.15 ≤ APMX (352-528)	Fz	0.0008	0.0016	0.0021	0.0025	0.0029	0.0037	
		HSM	4xD	394	Feed (ipm)	34	45	44	42	41	39
			≤ 0.1 ≤ APMX (315-473)	Fz	0.0008	0.0016	0.0022	0.0026	0.0030	0.0035	

continued on next page

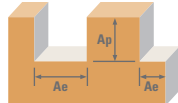

	Series 77, 77CR Fractional	Hardness	Ae x D ₁	Ap x D ₁	Vc (sfm)	D ₁ • inch							
						1/4	3/8	1/2	5/8	3/4	1		
N NON-FERROUS MATERIALS	Not Recommended for this Material Group												
	SUPER ALLOYS (NICKEL, COBALT, IRON BASE) Inconel 601, 617, 625, Incoloy, Monel 400	≤ 300 Bhn or ≤ 32 HRc	HSM	2.5xD	136	RPM	1925	1284	963	770	642	481	
				≤ 0.2	≤ APMX	(109-163)	Fz	0.0006	0.0011	0.0016	0.0018	0.0021	0.0025
				Feed (ipm)	8	10	11	10	9	8			
		HSM	3xD	141	Fz	0.0007	0.0012	0.0018	0.0021	0.0024	0.0028		
				≤ 0.15	≤ APMX	(113-169)	Feed (ipm)	9	11	12	11	11	9
				HSM	4xD	126	Fz	0.0007	0.0013	0.0018	0.0022	0.0025	0.0029
	SUPER ALLOYS (NICKEL, COBALT, IRON BASE) Inconel 718, X-750, Incoloy, Waspaloy, Hastelloy, Rene	≤ 400 Bhn or ≤ 43 HRc	HSM	2.5xD	85	RPM	1207	805	604	483	402	302	
				≤ 0.2	≤ APMX	(68-102)	Fz	0.0005	0.0009	0.0013	0.0015	0.0018	0.0022
				Feed (ipm)	4	5	5	5	5	5			
		HSM	3xD	88	Fz	0.0005	0.0010	0.0015	0.0018	0.0020	0.0025		
				≤ 0.15	≤ APMX	(70-106)	Feed (ipm)	4	6	6	6	6	5
HSM				4xD	79	Fz	0.0006	0.0011	0.0015	0.0018	0.0021	0.0026	
S TITANIUM ALLOYS Pure Titanium, Ti6Al4V, Ti6Al2Sn4Zr2Mo, Ti4Al4Mo2Sn0.5Si	≤ 350 Bhn or ≤ 38 HRc	HSM	2.5xD	289	RPM	4095	2730	2048	1638	1365	1024		
			≤ 0.2	≤ APMX	(231-347)	Fz	0.0008	0.0015	0.0021	0.0024	0.0028	0.0032	
			Feed (ipm)	23	29	30	28	27	23				
	HSM	3xD	299	Fz	0.0009	0.0017	0.0023	0.0025	0.0028	0.0036			
			≤ 0.15	≤ APMX	(239-359)	Feed (ipm)	26	32	33	29	27	26	
			HSM	4xD	268	Fz	0.0009	0.0018	0.0024	0.0029	0.0033	0.0037	
TITANIUM ALLOYS (DIFFICULT) Ti10Al2Fe3Al, Ti5Al5V5Mo3Cr, Ti7Al4Mo, Ti3Al8V6Cr4Zr4Mo, Ti6Al6V6Sn, Ti15V3 Cr3Sn3Al	≤ 440 Bhn or ≤ 47 HRc	HSM	2.5xD	170	RPM	2399	1599	1199	960	800	600		
			≤ 0.2	≤ APMX	(136-204)	Fz	0.0008	0.0015	0.0021	0.0024	0.0028	0.0032	
			Feed (ipm)	13	17	18	16	16	13				
	HSM	3xD	176	Fz	0.0009	0.0017	0.0023	0.0025	0.0028	0.0036			
			≤ 0.15	≤ APMX	(141-211)	Feed (ipm)	15	19	19	17	16	15	
			HSM	4xD	157	Fz	0.0009	0.0018	0.0024	0.0029	0.0033	0.0037	
H TOOL STEELS A2, D2, H13, L2, M2, P20, S7, T15, W2	≤ 375 Bhn or ≤ 40 HRc	HSM	2.5xD	272	RPM	3851	2567	1925	1540	1284	963		
			≤ 0.2	≤ APMX	(218-326)	Fz	0.0006	0.0011	0.0014	0.0017	0.0020	0.0024	
			Feed (ipm)	16	20	19	18	18	16				
	HSM	3xD	282	Fz	0.0007	0.0012	0.0016	0.0019	0.0022	0.0027			
			≤ 0.15	≤ APMX	(226-338)	Feed (ipm)	19	22	22	20	20	18	
			HSM	4xD	252	Fz	0.0007	0.0013	0.0017	0.0020	0.0023	0.0028	
	≤ 0.1	≤ APMX	(202-302)	Feed (ipm)	19	23	23	22	21	19			

Bhn (Brinell) HRc (Rockwell C) HSM (High Speed Machining)
 rpm = Vc x 3.82 / DC
 mm/min = Fz x 7 x rpm
 reduce speed and feed for materials harder than listed
 reduce feed and Ae when finish milling (.02 x DC maximum)
 feed rates listed have chip thinning adjustments included where applicable
 refer to the SGS Tool Wizard® for complete technical information (www.kyocera-sgstool.com)

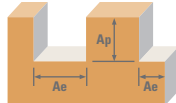

Series 77M, 77MCR Metric	Hardness	Ae x D ₁	Ap x D ₁	Vc (m/min)	D ₁ • mm						
					6	8	10	12	16	20	25
P CARBON STEELS 1018, 1040, 1080, 1090, 10L50, 1140, 1212, 12L15, 1525, 1536	≤ 275 Bhn or ≤ 28 HRC	HSM 2.5xD ≤ 0.2 ≤ APMX	284 (227-341)	RPM	12208	9156	7325	6104	4578	3662	2930
				Fz	0.0413	0.0411	0.0640	0.0711	0.0889	0.1013	0.1050
				Feed (ipm)	3529	2634	3282	3038	2849	2597	2154
		HSM 3xD ≤ 0.15 ≤ APMX	257 (206-308)	Fz	0.0347	0.0461	0.0717	0.0797	0.0996	0.1135	0.1176
				Feed (ipm)	2965	2955	3676	3405	3192	2910	2412
				HSM 4xD ≤ 0.1 ≤ APMX	230 (184-276)	Fz	0.0362	0.0480	0.0747	0.0830	0.1037
	Feed (ipm)	3094	3076			3830	3546	3323	3030	1885	
	RPM	8068	6051			4841	4034	3025	2420	1936	
	≤ 375 Bhn or ≤ 40 HRC	HSM 2.5xD ≤ 0.2 ≤ APMX	132 (106-159)	Fz	0.0213	0.0285	0.0512	0.0610	0.0711	0.0827	0.0875
				Feed (ipm)	1203	1207	1735	1723	1506	1401	1186
				HSM 3xD ≤ 0.15 ≤ APMX	138 (111-166)	Fz	0.0239	0.0319	0.0574	0.0683	0.0797
		Feed (ipm)	1350			1351	1945	1929	1688	1569	1328
HSM 4xD ≤ 0.1 ≤ APMX		152 (122-182)	Fz			0.0249	0.0332	0.0597	0.0711	0.0830	0.0964
			Feed (ipm)	1406	1406	2023	2008	1758	1633	1384	
	RPM		9660	7245	5796	4830	3623	2898	2318		
M STAINLESS STEELS (FREE MACHINING) 303, 416, 420F, 430F, 440F	≤ 275 Bhn or ≤ 28 HRC	HSM 2.5xD ≤ 0.2 ≤ APMX	197 (158-236)	Fz	0.0216	0.0285	0.0448	0.0533	0.0635	0.0747	0.0800
				Feed (ipm)	1461	1445	1818	1803	1610	1515	1298
				HSM 3xD ≤ 0.15 ≤ APMX	204 (163-245)	Fz	0.0242	0.0319	0.0502	0.0598	0.0711
		Feed (ipm)	1636			1618	2037	2022	1803	1698	1454
		HSM 4xD ≤ 0.1 ≤ APMX	182 (146-218)			Fz	0.0252	0.0332	0.0523	0.0622	0.0741
				Feed (ipm)	1704	1684	2122	2104	1879	1767	1514
	RPM			6369	4777	3822	3185	2389	1911	1529	
	≤ 275 Bhn or ≤ 28 HRC	HSM 2.5xD ≤ 0.2 ≤ APMX	130 (104-156)	Fz	0.0168	0.0221	0.0371	0.0432	0.0584	0.0693	0.0750
				Feed (ipm)	749	739	993	963	976	927	803
				HSM 3xD ≤ 0.15 ≤ APMX	134 (107-161)	Fz	0.0188	0.0248	0.0416	0.0484	0.0655
		Feed (ipm)	838			829	1113	1079	1095	1039	899
		HSM 4xD ≤ 0.1 ≤ APMX	120 (96-144)			Fz	0.0196	0.0258	0.0433	0.0504	0.0682
Feed (ipm)				874	863	1158	1124	1140	1082	936	
RPM	6104			4578	3662	3052	2289	1831	1465		
≤ 325 Bhn or ≤ 35 HRC	HSM 2.5xD ≤ 0.2 ≤ APMX	124 (99-149)	Fz	0.0168	0.0221	0.0371	0.0432	0.0584	0.0693	0.0750	
			Feed (ipm)	718	708	952	923	936	888	769	
			HSM 3xD ≤ 0.15 ≤ APMX	129 (103-155)	Fz	0.0188	0.0248	0.0416	0.0484	0.0655	0.0777
	Feed (ipm)	803			795	1066	1034	1050	996	861	
	HSM 4xD ≤ 0.1 ≤ APMX	115 (92-138)			Fz	0.0196	0.0258	0.0433	0.0504	0.0682	0.0809
			Feed (ipm)	837	827	1110	1077	1093	1037	897	
RPM			10722	8041	6433	5361	4021	3217	2573		
P CAST IRONS (LOW & MEDIUM ALLOY) Gray, Malleable, Ductile	≤ 220 Bhn or ≤ 19 HRC	HSM 2.5xD ≤ 0.2 ≤ APMX	218 (174-262)	Fz	0.0239	0.0315	0.0474	0.0559	0.0762	0.0880	0.0925
				Feed (ipm)	1794	1773	2135	2098	2145	1981	1666
				HSM 3xD ≤ 0.15 ≤ APMX	225 (180-270)	Fz	0.0268	0.0353	0.0531	0.0626	0.0854
		Feed (ipm)	2011			1987	2391	2349	2404	2220	1866
		HSM 4xD ≤ 0.1 ≤ APMX	202 (162-242)			Fz	0.0279	0.0368	0.0553	0.0652	0.0889
				Feed (ipm)	2094	2071	2490	2447	2502	2312	1944
	RPM			6369	4777	3822	3185	2389	1911	1529	
	≤ 260 Bhn or ≤ 26 HRC	HSM 2.5xD ≤ 0.2 ≤ APMX	130 (104-156)	Fz	0.0168	0.0221	0.0371	0.0432	0.0584	0.0693	0.0750
				Feed (ipm)	749	739	993	963	976	927	803
				HSM 3xD ≤ 0.15 ≤ APMX	134 (107-161)	Fz	0.0188	0.0248	0.0416	0.0484	0.0655
		Feed (ipm)	838			829	1113	1079	1095	1039	899
		HSM 4xD ≤ 0.1 ≤ APMX	120 (96-144)			Fz	0.0196	0.0258	0.0433	0.0504	0.0682
Feed (ipm)				874	863	1158	1124	1140	1082	936	
RPM	6104			4578	3662	3052	2289	1831	1465		
N NON-FERROUS MATERIALS	Not Recommended for this Material Group										

continued on next page

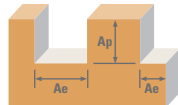

Series 77M, 77MCR Metric	Hardness	Ae x D ₁	Ap x D ₁	Vc (m/min)	D ₁ • mm							
					6	8	10	12	16	20	25	
SUPER ALLOYS (NICKEL, COBALT, IRON BASE) Inconel 601, 617, 625, Incoloy, Monel 400	≤ 300 Bhn or ≤ 32 HRc	HSM	2.5xD	41 (33-49)	RPM							
					Fz	2017	1513	1210	1008	756	605	484
		Feed (ipm)	198	194	249	251	242	237	212			
		HSM	3xD	43 (34-52)	Fz	0.0157	0.0205	0.0330	0.0398	0.0512	0.0627	0.0700
					Feed (ipm)	222	217	280	281	271	266	237
		HSM	4xD	38 (30-46)	Fz	0.0163	0.0213	0.0344	0.0415	0.0533	0.0653	0.0729
	Feed (ipm)				230	226	291	293	282	277	247	
	≤ 400 Bhn or ≤ 43 HRc	HSM	2.5xD	26 (21-31)	RPM							
					Fz	1274	955	764	637	478	382	306
		Feed (ipm)	102	102	130	136	127	128	118			
		HSM	3xD	27 (22-32)	Fz	0.0128	0.0171	0.0273	0.0342	0.0427	0.0538	0.0616
					Feed (ipm)	114	114	146	152	143	144	132
HSM		4xD	24 (19-29)	Fz	0.0133	0.0178	0.0284	0.0356	0.0445	0.0560	0.0642	
	Feed (ipm)			119	119	152	159	149	150	137		
TITANIUM ALLOYS Pure Titanium, Ti6Al4V, Ti6Al2Sn4Zr2Mo, Ti4Al4Mo2Sn0.5Si	≤ 350 Bhn or ≤ 38 HRc	HSM	2.5xD	88 (70-106)	RPM							
					Fz	4352	3264	2611	2176	1632	1306	1045
		Feed (ipm)	582	580	726	736	725	683	585			
		HSM	3xD	91 (73-109)	Fz	0.0213	0.0285	0.0445	0.0541	0.0711	0.0837	0.0896
					Feed (ipm)	649	651	813	824	812	765	655
		HSM	4xD	82 (66-98)	Fz	0.0222	0.0296	0.0463	0.0563	0.0741	0.0871	0.0933
	Feed (ipm)				676	676	846	858	847	796	682	
	≤ 440 Bhn or ≤ 47 HRc	HSM	2.5xD	52 (42-62)	RPM							
					Fz	2548	1911	1529	1274	955	764	611
		Feed (ipm)	291	340	425	431	425	400	342			
		HSM	3xD	54 (43-65)	Fz	0.0182	0.0285	0.0445	0.0541	0.0711	0.0837	0.0896
					Feed (ipm)	325	381	476	482	476	448	384
HSM		4xD	48 (38-58)	Fz	0.0190	0.0296	0.0463	0.0563	0.0741	0.0871	0.0933	
	Feed (ipm)			339	396	495	502	496	466	399		
TOOL STEELS A2, D2, H13, L2, M2, P20, S7, T15, W2	≤ 375 Bhn or ≤ 40 HRc	HSM	2.5xD	83 (66-100)	RPM							
					Fz	4087	3065	2452	2044	1533	1226	981
		Feed (ipm)	401	393	505	509	490	481	429			
		HSM	3xD	86 (69-103)	Fz	0.0157	0.0205	0.0330	0.0398	0.0512	0.0627	0.0700
					Feed (ipm)	449	440	566	569	549	538	481
		HSM	4xD	77 (62-92)	Fz	0.0163	0.0213	0.0344	0.0415	0.0533	0.0653	0.0729
	Feed (ipm)				466	457	590	594	572	560	501	

Bhn (Brinell) HRc (Rockwell C) HSM (High Speed Machining)
 rpm = (Vc x 1000) / (DC x 3.14)
 mm/min = Fz x 7 x rpm
 reduce speed and feed for materials harder than listed
 reduce feed and Ae when finish milling (.02 x DC maximum)
 feed rates listed have chip thinning adjustments included where applicable
 refer to the SGS Tool Wizard® for complete technical information (www.kyocera-sgtool.com)

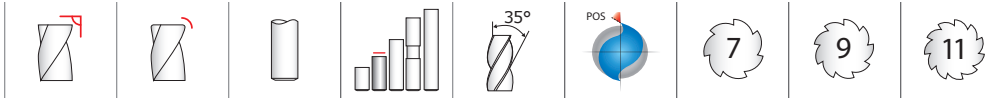

**66 •
66CR**
FRACTIONAL SERIES

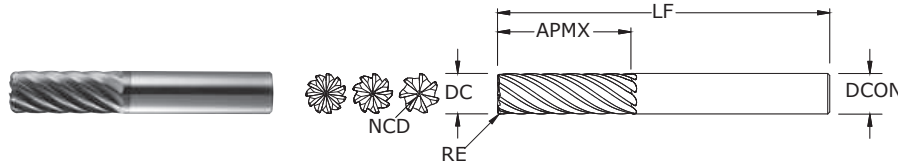

- Heavy core and rigid design allow for straight walls
- High flute count design results in smoother cutting performance and enhanced tool life in precise finishing applications
- Enhanced corner geometry with tight tolerance corner radii
- Recommended for materials ≤ 45 HRc (≤ 420 Bhn)

inch							EDP NO.
CUTTING DIAMETER DC	LENGTH OF CUT APMX	OVERALL LENGTH LF	SHANK DIAMETER DCON	CORNER RADIUS RE	NON-CUTTING CENTER DIAMETER NCD	NO. OF FLUTES	TI-NAMITE-X
3/16	5/8	2	3/16	—	0.0550	7	36620
3/16	5/8	2	3/16	.010	0.0550	7	36627
1/4	3/4	2-1/2	1/4	—	0.0650	7	36621
1/4	3/4	2-1/2	1/4	.015	0.0650	7	36628
3/8	1	3	3/8	—	0.0810	7	36622
3/8	1	3	3/8	.015	0.0810	7	36629
1/2	1-1/4	3	1/2	—	0.1340	9	36623
1/2	1-1/4	3	1/2	.030	0.1340	9	36630
1/2	1-1/4	3	1/2	.090	0.1340	9	36631
1/2	1-1/4	3	1/2	.120	0.1340	9	36632
5/8	1-5/8	3-1/2	5/8	—	0.1150	9	36624
5/8	1-5/8	3-1/2	5/8	.030	0.1150	9	36633
5/8	1-5/8	3-1/2	5/8	.090	0.1150	9	36634
5/8	1-5/8	3-1/2	5/8	.120	0.1150	9	36635
3/4	1-5/8	4	3/4	—	0.1750	11	36625
3/4	1-5/8	4	3/4	.030	0.1750	11	36636
3/4	1-5/8	4	3/4	.090	0.1750	11	36637
3/4	1-5/8	4	3/4	.120	0.1750	11	36638
1	2	6	1	—	0.3000	11	36626
1	2	6	1	.030	0.3000	11	36639
1	2	6	1	.090	0.3000	11	36640
1	2	6	1	.120	0.3000	11	36641

Neck Option Available

TOLERANCES (inch)

DC = +0.0000/-0.0020
DCON = h_6
RE = +0.0000/-0.0020

- STEELS
- STAINLESS STEELS
- CAST IRON
- HIGH TEMP ALLOYS
- TITANIUM
- HARDENED STEELS

For patent information visit www.ksptpatents.com

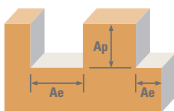

Series	Hardness	Ae x DC	Ap x DC	Vc (sfm)	DC • in									
					3/16	1/4	3/8	1/2	5/8	3/4	1			
Series 66, 66CR Fractional	CARBON STEELS 1018, 1040, 1080, 1090, 10L50, 1140, 1212, 12L15, 1525, 1536	Profile 	≤ 0.05	≤ 1	635	RPM	12937	9703	6469	4851	3881	3234	2426	
					(508-762)	Fz	0.0008	0.0012	0.0022	0.0030	0.0037	0.0038	0.0042	
						Feed (ipm)	72.4	81.5	99.6	131.0	129.2	135.2	112.1	
		Finish 	≤ 0.02	≤ 2	762	RPM	15524	11643	7762	5822	4657	3881	2911	
					(610-914)	Fz	0.0006	0.0010	0.0018	0.0024	0.0030	0.0030	0.0034	
						Feed (ipm)	69.5	78.2	95.6	125.7	124.1	129.8	107.6	
	ALLOY STEELS 4140, 4150, 4320, 5120, 5150, 8630, 86L20, 50100	≤ 375 Bhn or ≤ 40 HRc	Profile 	≤ 0.05	≤ 1	360	RPM	7334	5501	3667	2750	2200	1834	1375
						(288-432)	Fz	0.0006	0.0009	0.0017	0.0023	0.0029	0.0030	0.0032
							Feed (ipm)	30.8	34.7	43.6	56.9	57.4	60.5	48.4
		Finish 	≤ 0.02	≤ 2	432	RPM	8801	6601	4401	3300	2640	2200	1650	
					(346-518)	Fz	0.0005	0.0007	0.0014	0.0018	0.0023	0.0024	0.0026	
						Feed (ipm)	29.6	33.3	41.9	54.7	55.1	58.1	46.5	
STAINLESS STEELS (FREE MACHINING) 303, 416, 420F, 430F, 440F	≤ 275 Bhn or ≤ 28 HRc	Profile 	≤ 0.05	≤ 1	560	RPM	11409	8557	5705	4278	3423	2852	2139	
					(448-672)	Fz	0.0006	0.0009	0.0017	0.0023	0.0029	0.0030	0.0032	
						Feed (ipm)	47.9	53.9	67.9	88.6	89.3	94.1	75.3	
		Finish 	≤ 0.02	≤ 2	448	RPM	9127	6845	4564	3423	2738	2282	1711	
					(358-538)	Fz	0.0005	0.0007	0.0014	0.0018	0.0023	0.0024	0.0026	
						Feed (ipm)	30.7	34.5	43.4	56.7	57.2	60.2	48.2	
	STAINLESS STEELS (DIFFICULT) 304, 304L, 316, 316L	≤ 275 Bhn or ≤ 28 HRc	Profile 	≤ 0.05	≤ 1	385	RPM	7844	5883	3922	2941	2353	1961	1471
						(308-462)	Fz	0.0005	0.0007	0.0014	0.0018	0.0023	0.0024	0.0026
							Feed (ipm)	27.5	28.8	38.4	47.7	48.7	51.8	42.1
		Finish 	≤ 0.02	≤ 2	462	RPM	9412	7059	4706	3530	2824	2353	1765	
					(370-554)	Fz	0.0004	0.0006	0.0011	0.0014	0.0018	0.0019	0.0021	
						Feed (ipm)	26.4	27.7	36.9	45.7	46.8	49.7	40.4	
STAINLESS STEELS (PH) 13-8 PH, 15-5 PH, 17-4 PH, Custom 450	≤ 325 Bhn or ≤ 35 HRc	Profile 	≤ 0.05	≤ 1	355	RPM	7233	5424	3616	2712	2170	1808	1356	
					(284-426)	Fz	0.0005	0.0007	0.0014	0.0018	0.0023	0.0024	0.0026	
						Feed (ipm)	25.3	26.6	35.4	43.9	44.9	47.7	38.8	
	Finish 	≤ 0.02	≤ 2	426	RPM	8679	6509	4340	3255	2604	2170	1627		
				(341-511)	Fz	0.0004	0.0006	0.0011	0.0014	0.0018	0.0019	0.0021		
					Feed (ipm)	24.3	25.5	34.0	42.2	43.1	45.8	37.2		
CAST IRONS (LOW & MEDIUM ALLOY) Gray, Malleable, Ductile	≤ 220 Bhn or ≤ 19 HRc	Profile 	≤ 0.05	≤ 1	705	RPM	14363	10772	7182	5386	4309	3591	2693	
					(564-846)	Fz	0.0008	0.0012	0.0022	0.0030	0.0037	0.0038	0.0042	
						Feed (ipm)	80.4	90.5	110.6	145.4	143.5	150.1	124.4	
	Finish 	≤ 0.02	≤ 2	846	RPM	17236	12927	8618	6463	5171	4309	3232		
				(677-1015)	Fz	0.0006	0.0010	0.0018	0.0024	0.0030	0.0030	0.0034		
					Feed (ipm)	77.2	86.9	106.2	139.6	137.7	144.1	119.4		

continued on next page

FRACTIONAL Multi-Carb

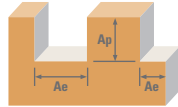

Series 66, 66CR Fractional	Hardness	Ae x DC	Ap x DC	Vc (sfm)	DC • in								
					3/16	1/4	3/8	1/2	5/8	3/4	1		
K CAST IRONS (HIGH ALLOY) Gray, Malleable, Ductile	≤ 260 Bhn or ≤ 26 HRc	Profile 	≤ 0.05	≤ 1	540	RPM	11002	8251	5501	4126	3300	2750	2063
					(432-648)	Fz	0.0006	0.0009	0.0017	0.0023	0.0029	0.0030	0.0032
					648	RPM	13202	9901	6601	4951	3961	3300	2475
		Finish 	≤ 0.02	≤ 2	(518-778)	Fz	0.0005	0.0007	0.0014	0.0018	0.0023	0.0024	0.0026
					648	RPM	13202	9901	6601	4951	3961	3300	2475
					648	RPM	13202	9901	6601	4951	3961	3300	2475
S SUPER ALLOYS (NICKEL, COBALT, IRON BASE) Inconel 601, 617, 625, Incoloy, Monel 400	≤ 300 Bhn or ≤ 32 HRc	Profile 	≤ 0.05	≤ 1	105	RPM	2139	1604	1070	802	642	535	401
					(84-126)	Fz	0.0005	0.0007	0.0014	0.0018	0.0023	0.0024	0.0026
					126	RPM	2567	1925	1284	963	770	642	481
		Finish 	≤ 0.02	≤ 2	(101-151)	Fz	0.0004	0.0006	0.0011	0.0014	0.0018	0.0019	0.0021
					126	RPM	2567	1925	1284	963	770	642	481
					126	RPM	2567	1925	1284	963	770	642	481
S SUPER ALLOYS (NICKEL, COBALT, IRON BASE) Inconel 718, X-750, Incoloy, Waspaloy, Hastelloy, Rene	≤ 400 Bhn or ≤ 43 HRc	Profile 	≤ 0.05	≤ 1	85	RPM	1732	1299	866	649	520	433	325
					(68-102)	Fz	0.0003	0.0005	0.0009	0.0011	0.0014	0.0015	0.0016
					102	RPM	2078	1559	1039	779	623	520	390
		Finish 	≤ 0.02	≤ 2	(82-122)	Fz	0.0002	0.0004	0.0007	0.0009	0.0011	0.0012	0.0013
					102	RPM	2078	1559	1039	779	623	520	390
					102	RPM	2078	1559	1039	779	623	520	390
S TITANIUM ALLOYS Pure Titanium, Ti6Al4V, Ti6Al2Sn4Zr2Mo, Ti4Al4Mo2Sn0.5Si	≤ 350 Bhn or ≤ 38 HRc	Profile 	≤ 0.05	≤ 1	390	RPM	7946	5959	3973	2980	2384	1986	1490
					(312-468)	Fz	0.0005	0.0008	0.0015	0.0021	0.0026	0.0027	0.0029
					468	RPM	9535	7151	4767	3576	2860	2384	1788
		Finish 	≤ 0.02	≤ 2	(374-562)	Fz	0.0004	0.0006	0.0012	0.0017	0.0021	0.0022	0.0023
					468	RPM	9535	7151	4767	3576	2860	2384	1788
					468	RPM	9535	7151	4767	3576	2860	2384	1788
S TITANIUM ALLOYS (DIFFICULT) Ti10Al2Fe3Al, Ti5Al5V5Mo3Cr, Ti7Al4Mo, Ti3Al8V6Cr4Zr4Mo, Ti6Al6V6Sn, Ti15V3 Cr3Sn3Al	≤ 440 Bhn or ≤ 47 HRc	Profile 	≤ 0.05	≤ 1	140	RPM	2852	2139	1426	1070	856	713	535
					(112-168)	Fz	0.0005	0.0008	0.0015	0.0021	0.0026	0.0027	0.0029
					168	RPM	3423	2567	1711	1284	1027	856	642
		Finish 	≤ 0.02	≤ 2	(134-202)	Fz	0.0004	0.0006	0.0012	0.0017	0.0021	0.0022	0.0023
					168	RPM	3423	2567	1711	1284	1027	856	642
					168	RPM	3423	2567	1711	1284	1027	856	642
H TOOL STEELS A2, D2, H13, L2, M2, P20, S7, T15, W2	≤ 375 Bhn or ≤ 40 HRc	Profile 	≤ 0.05	≤ 1	290	RPM	5908	4431	2954	2216	1772	1477	1108
					(232-348)	Fz	0.0004	0.0006	0.0012	0.0016	0.0020	0.0021	0.0022
					348	RPM	7090	5317	3545	2659	2127	1772	1329
		Finish 	≤ 0.02	≤ 2	(278-418)	Fz	0.0003	0.0005	0.0010	0.0013	0.0016	0.0017	0.0018
					348	RPM	7090	5317	3545	2659	2127	1772	1329
					348	RPM	7090	5317	3545	2659	2127	1772	1329

Bhn (Brinell) HRc (Rockwell C)
 $rpm = Vc \times 3.82 / DC$
 $ipm = Fz \times \text{number of flutes} \times rpm$
 reduce speed and feed for materials harder than listed
 feed rates listed have chip thinning adjustments included where applicable
 refer to the SGS Tool Wizard® for complete technical information (www.kyocera-sgstool.com)



**66M •
66MCR**
METRIC SERIES

TOLERANCES (mm)

DC = +0,000/-0,050
DCON = h_6
RE = +0,000/-0,050

- STEELS
- STAINLESS STEELS
- CAST IRON
- HIGH TEMP ALLOYS
- TITANIUM
- HARDENED STEELS

For patent information visit www.ksptpatents.com

mm							EDP NO.
CUTTING DIAMETER DC	LENGTH OF CUT APMX	OVERALL LENGTH LF	SHANK DIAMETER DCON	CORNER RADIUS RE	NON-CUTTING CENTER DIAMETER NCD	NO. OF FLUTES	TI-NAMITE-X
6,0	19,0	63,0	6,0	—	1,63	7	46620
8,0	20,0	63,0	8,0	0,5	1,63	7	46627
6,0	19,0	63,0	6,0	1,0	1,63	7	46628
8,0	20,0	63,0	8,0	—	1,78	7	46621
8,0	20,0	63,0	8,0	0,5	1,78	7	46629
8,0	20,0	63,0	8,0	1,0	1,78	7	46630
8,0	20,0	63,0	8,0	1,5	1,78	7	46631
10,0	22,0	75,0	10,0	—	2,03	7	46622
10,0	22,0	75,0	10,0	0,5	2,03	7	46632
10,0	22,0	75,0	10,0	1,0	2,03	7	46633
10,0	22,0	75,0	10,0	1,5	2,03	7	46634
10,0	22,0	75,0	10,0	2,0	2,03	7	46635
12,0	26,0	83,0	12,0	—	3,45	9	46623
12,0	26,0	83,0	12,0	1,0	3,45	9	46636
12,0	26,0	83,0	12,0	1,5	3,45	9	46637
12,0	26,0	83,0	12,0	2,0	3,45	9	46638
12,0	26,0	83,0	12,0	2,5	3,45	9	46639
12,0	26,0	83,0	12,0	3,0	3,45	9	46640
16,0	32,0	92,0	16,0	—	2,92	9	46624
16,0	32,0	92,0	16,0	1,0	2,92	9	46641
16,0	32,0	92,0	16,0	1,5	2,92	9	46642
16,0	32,0	92,0	16,0	2,0	2,92	9	46643
16,0	32,0	92,0	16,0	2,5	2,92	9	46644
16,0	32,0	92,0	16,0	3,0	2,92	9	46645
16,0	32,0	92,0	16,0	4,0	2,92	9	46646
20,0	38,0	104,0	20,0	—	4,57	11	46625
20,0	38,0	104,0	20,0	1,0	4,57	11	46647
20,0	38,0	104,0	20,0	1,5	4,57	11	46648
20,0	38,0	104,0	20,0	2,0	4,57	11	46649
20,0	38,0	104,0	20,0	2,5	4,57	11	46650
20,0	38,0	104,0	20,0	3,0	4,57	11	46651
20,0	38,0	104,0	20,0	4,0	4,57	11	46652

- Heavy core and rigid design allow for straight walls
- High flute count design results in smoother cutting performance and enhanced tool life in precise finishing applications
- Enhanced corner geometry with tight tolerance corner radii
- Recommended for materials ≤ 45 HRC (≤ 420 Bhn)

continued on next page

Neck Option Available

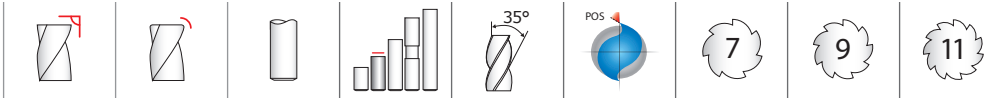

66M • 66MCR
METRIC SERIES

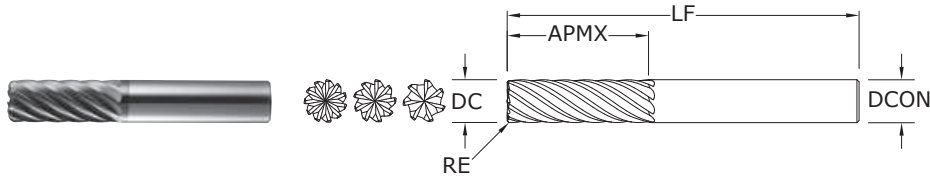

CONTINUED

mm							EDP NO.
CUTTING DIAMETER DC	LENGTH OF CUT APMX	OVERALL LENGTH LF	SHANK DIAMETER DCON	CORNER RADIUS RE	NON-CUTTING CENTER DIAMETER NCD	NO. OF FLUTES	TI-NAMITE-X
20,0	38,0	104,0	20,0	5,0	4,57	11	46653
25,0	38,0	104,0	25,0	—	7,49	11	46626
25,0	38,0	104,0	25,0	1,0	7,49	11	46654
25,0	38,0	104,0	25,0	1,5	7,49	11	46655
25,0	38,0	104,0	25,0	2,0	7,49	11	46656
25,0	38,0	104,0	25,0	2,5	7,49	11	46657
25,0	38,0	104,0	25,0	3,0	7,49	11	46658
25,0	38,0	104,0	25,0	4,0	7,49	11	46659
25,0	38,0	104,0	25,0	5,0	7,49	11	46660

Neck Option Available

TOLERANCES (mm)

DC = +0,000/-0,050
DCON = h₆
RE = +0,000/-0,050

- STEELS
- STAINLESS STEELS
- CAST IRON
- HIGH TEMP ALLOYS
- TITANIUM
- HARDENED STEELS

For patent information visit www.ksptpatents.com

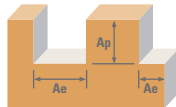

Series 66M, 66MCR	Metric	Hardness	Ae x DC	Ap x DC	Vc (m/min)	DC • mm								
						6	8	10	12	16	20	25		
P	CARBON STEELS 1018, 1040, 1080, 1090, 10L50, 1140, 1212, 12L15, 1525, 1536	≤ 275 Bhn or ≤ 28 HRc	Profile 	≤ 0.05	≤ 1	194	RPM	10260	7695	6156	5130	3847	3078	2462
						(155-232)	Fz	0.029	0.047	0.059	0.072	0.095	0.101	0.105
						Feed (mm/min)	2068	2528	2528	3324	3280	3431	2844	
		Finish 	≤ 0.02	≤ 2	232	RPM	12312	9234	7387	6156	4617	3693	2955	
					(186-279)	Fz	0.023	0.038	0.047	0.058	0.076	0.081	0.084	
					Feed (mm/min)	1985	2427	2427	3191	3149	3294	2730		
	ALLOY STEELS 4140, 4150, 4320, 5120, 5150, 8630, 86L20, 50100	≤ 375 Bhn or ≤ 40 HRc	Profile 	≤ 0.05	≤ 1	110	RPM	5816	4362	3490	2908	2181	1745	1396
						(88-132)	Fz	0.022	0.036	0.045	0.055	0.074	0.080	0.080
						Feed (mm/min)	879	1108	1107	1445	1457	1536	1229	
		Finish 	≤ 0.02	≤ 2	132	RPM	6980	5235	4188	3490	2617	2094	1675	
					(105-158)	Fz	0.017	0.029	0.036	0.044	0.059	0.064	0.064	
					Feed (mm/min)	844	1063	1063	1387	1399	1474	1179		
M	STAINLESS STEELS (FREE MACHINING) 303, 416, 420F, 430F, 440F	≤ 275 Bhn or ≤ 28 HRc	Profile 	≤ 0.05	≤ 1	171	RPM	9048	6786	5429	4524	3393	2714	2171
						(137-205)	Fz	0.022	0.036	0.045	0.055	0.074	0.080	0.080
						Feed (mm/min)	1368	1723	1723	2247	2267	2389	1911	
		Finish 	≤ 0.02	≤ 2	137	RPM	7238	5429	4343	3619	2714	2171	1737	
					(109-164)	Fz	0.017	0.029	0.036	0.044	0.059	0.064	0.064	
					Feed (mm/min)	875	1103	1103	1438	1451	1529	1223		
	STAINLESS STEELS (DIFFICULT) 304, 304L, 316, 316L	≤ 275 Bhn or ≤ 28 HRc	Profile 	≤ 0.05	≤ 1	117	RPM	6220	4665	3732	3110	2333	1866	1493
						(94-141)	Fz	0.017	0.030	0.037	0.043	0.059	0.064	0.065
						Feed (mm/min)	731	975	975	1209	1236	1314	1067	
		Finish 	≤ 0.02	≤ 2	141	RPM	7465	5598	4479	3732	2799	2239	1791	
					(113-169)	Fz	0.013	0.024	0.030	0.035	0.047	0.051	0.052	
					Feed (mm/min)	702	17	936	1161	1187	1261	1025		
STAINLESS STEELS (PH) 13-8 PH, 15-5 PH, 17-4 PH, Custom 450	≤ 325 Bhn or ≤ 35 HRc	Profile 	≤ 0.05	≤ 1	108	RPM	5736	4302	3441	2868	2151	1721	1377	
					(87-130)	Fz	0.017	0.030	0.037	0.043	0.059	0.064	0.065	
					Feed (mm/min)	674	899	899	1115	1140	1211	984		
	Finish 	≤ 0.02	≤ 2	130	RPM	6883	5162	4130	3441	2581	2065	1652		
				(104-156)	Fz	0.013	0.024	0.030	0.035	0.047	0.051	0.052		
				Feed (mm/min)	647	863	863	1070	1094	1163	945			
K	CAST IRONS (LOW & MEDIUM ALLOY) Gray, Malleable, Ductile	≤ 220 Bhn or ≤ 19 HRc	Profile 	≤ 0.05	≤ 1	215	RPM	11391	8543	6834	5695	4271	3417	2734
						(172-258)	Fz	0.029	0.047	0.059	0.072	0.095	0.101	0.105
						Feed (mm/min)	2296	2807	2807	3690	3641	3809	3158	
		Finish 	≤ 0.02	≤ 2	258	RPM	13669	10252	8201	6834	5126	4101	3281	
					(206-309)	Fz	0.023	0.038	0.047	0.058	0.076	0.081	0.084	
					Feed (mm/min)	2204	2695	2694	3543	3496	3657	3031		

continued on next page

Multi-Carb

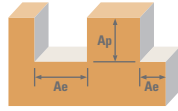

Series 66M, 66MCR	Metric	Hardness	Ae x DC	Ap x DC	Vc (m/min)	DC • mm								
						6	8	10	12	16	20	25		
K	CAST IRONS (HIGH ALLOY) Gray, Malleable, Ductile	≤ 260 Bhn or ≤ 26 HRc	Profile	≤ 0.05	≤ 1	165	RPM	8725	6544	5235	4362	3272	2617	2094
						(132-198)	Fz	0.022	0.036	0.045	0.055	0.074	0.080	0.080
						198	RPM	10470	7852	6282	5235	3926	3141	2513
						(158-237)	Fz	0.017	0.029	0.036	0.044	0.059	0.064	0.064
						1266	Feed (mm/min)	1319	1661	1661	2167	2186	2303	1843
						192	Feed (mm/min)	1266	1595	1595	2080	2099	2211	1769
S	SUPER ALLOYS (NICKEL, COBALT, IRON BASE) Inconel 601, 617, 625, Incoloy, Monel 400	≤ 300 Bhn or ≤ 32 HRc	Profile	≤ 0.05	≤ 1	32	RPM	1696	1272	1018	848	636	509	407
						(26-38)	Fz	0.017	0.030	0.037	0.043	0.059	0.064	0.065
						38	RPM	2036	1527	1221	1018	763	611	489
						(31-46)	Fz	0.013	0.024	0.030	0.035	0.047	0.051	0.052
						192	Feed (mm/min)	199	266	213	330	337	358	291
						111	Feed (mm/min)	192	255	255	317	324	344	279
S	SUPER ALLOYS (NICKEL, COBALT, IRON BASE) Inconel 718, X-750, Incoloy, Waspaloy, Hastelloy, Rene	≤ 400 Bhn or ≤ 43 HRc	Profile	≤ 0.05	≤ 1	26	RPM	1373	1030	824	687	515	412	330
						(21-31)	Fz	0.012	0.019	0.024	0.026	0.036	0.040	0.040
						31	RPM	1648	1236	989	824	618	494	396
						(25-37)	Fz	0.010	0.015	0.019	0.021	0.029	0.032	0.032
						111	Feed (mm/min)	115	138	138	163	166	181	145
						111	Feed (mm/min)	111	133	133	157	159	174	139
S	TITANIUM ALLOYS Pure Titanium, Ti6Al4V, Ti6Al2Sn4Zr2Mo, Ti4Al4Mo2Sn0.5Si	≤ 350 Bhn or ≤ 38 HRc	Profile	≤ 0.05	≤ 1	119	RPM	6301	4726	3781	3151	2363	1890	1512
						(95-143)	Fz	0.019	0.032	0.040	0.050	0.067	0.072	0.073
						143	RPM	7561	5671	4537	3781	2836	2268	1815
						(114-171)	Fz	0.015	0.026	0.032	0.040	0.053	0.058	0.058
						813	Feed (mm/min)	847	1059	1059	1429	1415	1497	1206
						292	Feed (mm/min)	813	1016	1016	1372	1359	1437	1158
S	TITANIUM ALLOYS (DIFFICULT) Ti10Al2Fe3Al, Ti5Al5V5Mo3Cr, Ti7Al4Mo, Ti3Al8V6Cr4Zr4Mo, Ti6Al6V6Sn, Ti15V3 Cr3Sn3Al	≤ 440 Bhn or ≤ 47 HRc	Profile	≤ 0.05	≤ 1	43	RPM	2262	1696	1357	1131	848	679	543
						(34-51)	Fz	0.019	0.032	0.040	0.050	0.067	0.072	0.073
						51	RPM	2714	2036	1629	1357	1018	814	651
						(41-61)	Fz	0.015	0.026	0.032	0.040	0.053	0.058	0.058
						292	Feed (mm/min)	304	380	380	513	508	537	433
						292	Feed (mm/min)	292	365	365	492	488	516	416
H	TOOL STEELS A2, D2, H13, L2, M2, P20, S7, T15, W2	≤ 375 Bhn or ≤ 40 HRc	Profile	≤ 0.05	≤ 1	88	RPM	4686	3514	2811	2343	1757	1406	1125
						(71-106)	Fz	0.014	0.026	0.032	0.038	0.051	0.056	0.055
						106	RPM	5623	4217	3374	2811	2108	1687	1349
						(85-127)	Fz	0.012	0.020	0.026	0.031	0.041	0.045	0.044
						453	Feed (mm/min)	472	630	630	810	810	866	680
						453	Feed (mm/min)	453	605	605	777	777	831	653

Bhn (Brinell) HRc (Rockwell C)
 rpm = (Vc x 1000) / (DC x 3.14)
 mm/min = Fz x number of flutes x rpm
 reduce speed and feed for materials harder than listed
 feed rates listed have chip thinning adjustments included where applicable
 refer to the SGS Tool Wizard® for complete technical information (www.kyocera-sgstool.com)

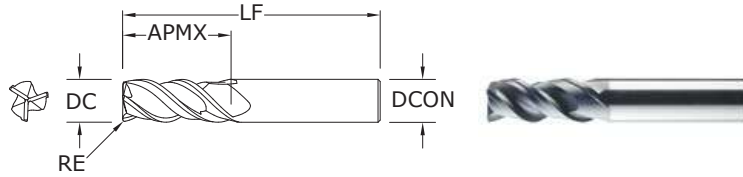

33CR
FRACTIONAL SERIES

TOLERANCES (inch)

1/8–1/4 DIAMETER

DC = +0.0000/-0.0012

DCON = h_6

RE = +0.0000/-0.0020

>1/4–3/8 DIAMETER

DC = +0.0000/-0.0016

DCON = h_6

RE = +0.0000/-0.0020

>3/8–1 DIAMETER

DC = +0.0000/-0.0020

DCON = h_6

RE = +0.0000/-0.0020

STEELS

STAINLESS STEELS

CAST IRON

HIGH TEMP ALLOYS

TITANIUM

HARDENED STEELS

CUTTING DIAMETER DC	LENGTH OF CUT APMX	inch			CORNER RADIUS RE	EDP NO. TI-NAMITE-A (AITiN)
		OVERALL LENGTH LF	SHANK DIAMETER DCON			
1/8	3/8	2-1/2	1/4	.015	33345	
3/16	9/16	2-1/2	1/4	.015	33346	
1/4	3/4	2-1/2	1/4	.020	33347	
5/16	13/16	2-1/2	5/16	.020	33348	
3/8	1	2-1/2	3/8	.020	33349	
7/16	1-1/8	2-3/4	7/16	.020	33350	
1/2	1-1/4	3-1/4	1/2	.030	33351	
5/8	1-1/2	3-1/2	5/8	.040	33352	
3/4	1-3/4	4	3/4	.040	33353	
1	2-1/4	5	1	.040	33354	

- Specially engineered step core design provides stability for aggressive ramping and rigidity when flutes are completely engaged
- Open design at axial end accommodates material flow and load reduction during machining operations
- Enhanced corner geometry with tight tolerance corner radii
- Recommended for materials ≤ 45 HRc (≤ 420 Bhn)

For patent information visit www.ksptpatents.com

FRACTIONAL
Series 33

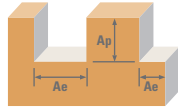

Series 33CR Fractional	Hardness	Ae x DC	Ap x DC	Vc (sfm)	DC • in									
					1/8	1/4	3/8	1/2	5/8	3/4	1			
P CARBON STEELS 1018, 1040, 1080, 1090, 10L50, 1140, 1212, 12L15, 1525, 1536	≤ 275 Bhn or ≤ 28 HRc	Profile 	≤ 0.5	≤ 1.5	550	RPM	16808	8404	5603	4202	3362	2801	2101	
					(440-660)	Fz	0.0005	0.0012	0.0023	0.0031	0.0039	0.0040	0.0043	
						Feed (ipm)	25.2	30.3	38.7	39.1	39.3	33.6	27.1	
		Slot 	1	≤ 1	440	RPM	13446	6723	4482	3362	2689	2241	1681	
					(352-528)	Fz	0.0005	0.0012	0.0023	0.0031	0.0039	0.0040	0.0043	
						Feed (ipm)	20.2	24.2	30.9	31.3	31.5	26.9	21.7	
	ALLOY STEELS 4140, 4150, 4320, 5120, 5150, 8630, 86L20, 50100	≤ 375 Bhn or ≤ 40 HRc	Profile 	≤ 0.5	≤ 1.5	315	RPM	9626	4813	3209	2407	1925	1604	1203
						(252-378)	Fz	0.0004	0.0009	0.0017	0.0023	0.0029	0.0030	0.0032
							Feed (ipm)	11.6	13.0	16.4	16.6	16.7	14.4	11.6
			Slot 	1	≤ 1	250	RPM	7640	3820	2547	1910	1528	1273	955
						(200-300)	Fz	0.0004	0.0009	0.0017	0.0023	0.0029	0.0030	0.0032
							Feed (ipm)	9.2	10.3	13.0	13.2	13.3	11.5	9.2
M STAINLESS STEELS (FREE MACHINING) 303, 416, 420F, 430F, 440F	≤ 275 Bhn or ≤ 28 HRc	Profile 	≤ 0.5	≤ 1.5	490	RPM	14974	7487	4991	3744	2995	2496	1872	
					(392-588)	Fz	0.0004	0.0010	0.0019	0.0025	0.0031	0.0032	0.0035	
						Feed (ipm)	17.1	22.5	28.5	28.1	27.9	24.0	19.7	
		Slot 	1	≤ 1	390	RPM	11918	5959	3973	2980	2384	1986	1490	
					(312-468)	Fz	0.0004	0.0010	0.0019	0.0025	0.0031	0.0032	0.0035	
						Feed (ipm)	13.6	17.9	22.6	22.3	22.2	19.1	15.6	
	STAINLESS STEELS (DIFFICULT) 304, 304L, 316, 316L	≤ 275 Bhn or ≤ 28 HRc	Profile 	≤ 0.5	≤ 1.5	340	RPM	10390	5195	3463	2598	2078	1732	1299
						(272-408)	Fz	0.0003	0.0008	0.0015	0.0020	0.0025	0.0026	0.0028
							Feed (ipm)	9.4	12.5	15.6	15.6	15.6	13.5	10.9
			Slot 	1	≤ 1	270	RPM	8251	4126	2750	2063	1650	1375	1031
						(216-324)	Fz	0.0003	0.0008	0.0015	0.0020	0.0025	0.0026	0.0028
							Feed (ipm)	7.4	9.9	12.4	12.4	12.4	10.7	8.7
STAINLESS STEELS (PH) 13-8 PH, 15-5 PH, 17-4 PH, Custom 450	≤ 325 Bhn or ≤ 35 HRc	Profile 	≤ 0.5	≤ 1.5	310	RPM	9474	4737	3158	2368	1895	1579	1184	
					(248-372)	Fz	0.0003	0.0008	0.0015	0.0020	0.0025	0.0026	0.0028	
						Feed (ipm)	8.5	11.4	14.2	14.2	14.2	12.3	9.9	
		Slot 	1	≤ 1	250	RPM	7640	3820	2547	1910	1528	1273	955	
					(200-300)	Fz	0.0003	0.0008	0.0015	0.0020	0.0025	0.0026	0.0028	
						Feed (ipm)	6.9	9.2	11.5	11.5	11.5	9.9	8.0	
K CAST IRONS (LOW & MEDIUM ALLOY) Gray, Malleable, Ductile	≤ 220 Bhn or ≤ 19 HRc	Profile 	≤ 0.5	≤ 1.5	445	RPM	13599	6800	4533	3400	2720	2267	1700	
					(356-534)	Fz	0.0004	0.0011	0.0021	0.0028	0.0035	0.0036	0.0039	
						Feed (ipm)	14.3	22.4	28.6	28.6	28.6	24.5	19.9	
		Slot 	1	≤ 1	355	RPM	10849	5424	3616	2712	2170	1808	1356	
					(284-426)	Fz	0.0004	0.0011	0.0021	0.0028	0.0035	0.0036	0.0039	
						Feed (ipm)	11.4	17.9	22.8	22.8	22.8	19.5	15.9	

continued on next page

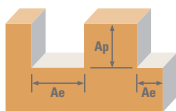

Series	33CR	Fractional	Hardness	Ae x DC	Ap x DC	Vc (sfm)	DC • in							
							1/8	1/4	3/8	1/2	5/8	3/4	1	
K	CAST IRONS (HIGH ALLOY) Gray, Malleable, Ductile	≤ 260 Bhn or ≤ 26 HRC	Profile 	≤ 0.5	≤ 1.5	340	RPM	10390	5195	3463	2598	2078	1732	1299
						(272-408)	Fz	0.0003	0.0008	0.0016	0.0021	0.0026	0.0027	0.0029
						Feed (ipm)	9.4	12.5	16.6	16.4	16.2	14.0	11.3	
			Slot 	1	≤ 1	270	RPM	8251	4126	2750	2063	1650	1375	1031
						(216-324)	Fz	0.0003	0.0008	0.0016	0.0021	0.0026	0.0027	0.0029
						Feed (ipm)	7.4	9.9	13.2	13.0	12.9	11.1	9.0	
	SUPER ALLOYS (NICKEL, COBALT, IRON BASE) Inconel 601, 617, 625, Incoloy, Monel 400	≤ 300 Bhn or ≤ 32 HRC	Profile 	≤ 0.5	≤ 1.5	80	RPM	2445	1222	815	611	489	407	306
						(64-96)	Fz	0.0003	0.0007	0.0013	0.0017	0.0021	0.0022	0.0024
						Feed (ipm)	1.9	2.6	3.2	3.1	3.1	2.7	2.2	
			Slot 	1	≤ 1	65	RPM	1986	993	662	497	397	331	248
						(52-78)	Fz	0.0003	0.0007	0.0013	0.0017	0.0021	0.0022	0.0024
						Feed (ipm)	1.5	2.1	2.6	2.5	2.5	2.2	1.8	
SUPER ALLOYS (NICKEL, COBALT, IRON BASE) Inconel 718, X-750, Incoloy, Waspaloy, Hastelloy, Rene	≤ 400 Bhn or ≤ 43 HRC	Profile 	≤ 0.5	≤ 1.5	62	RPM	1895	947	632	474	379	316	237	
					(50-74)	Fz	0.0002	0.0005	0.0009	0.0012	0.0015	0.0016	0.0017	
					Feed (ipm)	1.1	1.4	1.7	1.7	1.7	1.5	1.2		
		Slot 	1	≤ 1	49	RPM	1497	749	499	374	299	250	187	
					(39-59)	Fz	0.0002	0.0005	0.0009	0.0012	0.0015	0.0016	0.0017	
					Feed (ipm)	0.9	1.1	1.3	1.3	1.3	1.2	1.0		
S	TITANIUM ALLOYS Pure Titanium, Ti6Al4V, Ti6Al2Sn4Zr2Mo, Ti4Al4Mo2Sn0.5Si	≤ 350 Bhn or ≤ 38 HRC	Profile 	≤ 0.5	≤ 1.5	215	RPM	6570	3285	2190	1643	1314	1095	821
						(172-258)	Fz	0.0003	0.0008	0.0015	0.0020	0.0025	0.0026	0.0028
						Feed (ipm)	5.9	7.9	9.9	9.9	9.9	8.5	6.9	
			Slot 	1	≤ 1	170	RPM	5195	2598	1732	1299	1039	866	649
						(136-204)	Fz	0.0003	0.0008	0.0015	0.0020	0.0025	0.0026	0.0028
						Feed (ipm)	4.7	6.2	7.8	7.8	7.8	6.8	5.5	
	TITANIUM ALLOYS (DIFFICULT) Ti10Al2Fe3Al, Ti5Al5V5Mo3Cr, Ti7Al4Mo, Ti3Al8V6Cr4Zr4Mo, Ti6Al6V6Sn, Ti15V3 Cr3Sn3Al	≤ 440 Bhn or ≤ 47 HRC	Profile 	≤ 0.5	≤ 1.5	75	RPM	2292	1146	764	573	458	382	287
						(60-90)	Fz	0.0003	0.0008	0.0015	0.0020	0.0025	0.0026	0.0028
						Feed (ipm)	2.1	2.8	3.4	3.4	3.4	3.0	2.4	
			Slot 	1	≤ 1	60	RPM	1834	917	611	458	367	306	229
						(48-72)	Fz	0.0003	0.0008	0.0015	0.0020	0.0025	0.0026	0.0028
						Feed (ipm)	1.7	2.2	2.8	2.8	2.8	2.4	1.9	
H	TOOL STEELS A2, D2, H13, L2, M2, P20, S7, T15, W2	≤ 375 Bhn or ≤ 40 HRC	Profile 	≤ 0.5	≤ 1.5	185	RPM	5654	2827	1885	1413	1131	942	707
						(148-222)	Fz	0.0003	0.0007	0.0014	0.0018	0.0023	0.0024	0.0025
						Feed (ipm)	5.1	5.9	7.9	7.6	7.8	6.8	5.3	
			Slot 	1	≤ 1	145	RPM	4431	2216	1477	1108	886	739	554
						(116-174)	Fz	0.0003	0.0007	0.0014	0.0018	0.0023	0.0024	0.0025
						Feed (ipm)	4.0	4.7	6.2	6.0	6.1	5.3	4.2	

Bhn (Brinell) HRC (Rockwell C)

rpm = Vc x 3.82 / DC

ipm = Fz x 3 x rpm

reduce speed and feed for materials harder than listed

reduce feed and Ae when finish milling (.02 x DC maximum)

feed rates listed have chip thinning adjustments included where applicable

refer to the SGS Tool Wizard® for complete technical information (www.kyocera-sgstoool.com)



33MCR METRIC SERIES

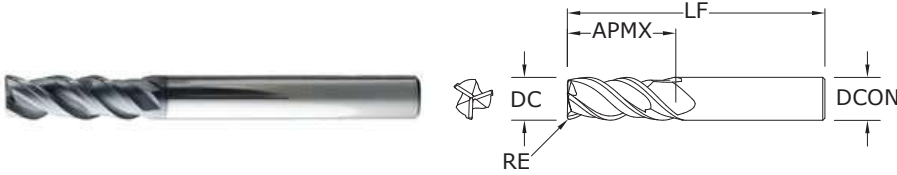

- Specially engineered step core design provides stability for aggressive ramping and rigidity when flutes are completely engaged
- Open design at axial end accommodates material flow and load reduction during machining operations
- Enhanced corner geometry with tight tolerance corner radii
- Recommended for materials ≤ 45 HRc (≤ 420 Bhn)

CUTTING DIAMETER DC	LENGTH OF CUT APMX	mm			CORNER RADIUS RE	EDP NO. TI-NAMITE-A (AlTiN)
		OVERALL LENGTH LF	SHANK DIAMETER DCON			
3,0	9,0	57,0	6,0	0,3	43445	
3,0	9,0	57,0	6,0	0,5	43470	
4,0	12,0	57,0	6,0	0,3	43446	
4,0	12,0	57,0	6,0	0,5	43471	
5,0	15,0	57,0	6,0	0,3	43447	
5,0	15,0	57,0	6,0	0,5	43472	
6,0	18,0	57,0	6,0	0,5	43448	
6,0	18,0	57,0	6,0	1,0	43473	
6,0	18,0	57,0	6,0	1,5	43474	
6,0	18,0	57,0	6,0	2,0	43475	
8,0	20,0	63,0	8,0	0,5	43449	
8,0	20,0	63,0	8,0	1,0	43476	
8,0	20,0	63,0	8,0	1,5	43477	
8,0	20,0	63,0	8,0	2,0	43478	
10,0	27,0	72,0	10,0	0,5	43450	
10,0	27,0	72,0	10,0	1,0	43479	
10,0	27,0	72,0	10,0	1,5	43480	
10,0	27,0	72,0	10,0	2,0	43481	
10,0	27,0	72,0	10,0	2,5	43482	
12,0	30,0	83,0	12,0	0,5	43451	
12,0	30,0	83,0	12,0	1,0	43483	
12,0	30,0	83,0	12,0	1,5	43484	
12,0	30,0	83,0	12,0	2,0	43485	
12,0	30,0	83,0	12,0	2,5	43486	
12,0	30,0	83,0	12,0	3,0	43487	
12,0	30,0	83,0	12,0	4,0	43488	
16,0	38,0	92,0	16,0	1,0	43452	
16,0	38,0	92,0	16,0	1,5	43489	
16,0	38,0	92,0	16,0	2,0	43490	
16,0	38,0	92,0	16,0	2,5	43491	
16,0	38,0	92,0	16,0	3,0	43492	
16,0	38,0	92,0	16,0	4,0	43493	
20,0	46,0	104,0	20,0	1,0	43453	
20,0	46,0	104,0	20,0	2,0	43494	
20,0	46,0	104,0	20,0	2,5	43495	
20,0	46,0	104,0	20,0	3,0	43496	
20,0	46,0	104,0	20,0	4,0	43497	

TOLERANCES (mm)

3-6 DIAMETER

DC = +0,000/-0,030
 DCON = h_6
 RE = +0,000/-0,050

>6-10 DIAMETER

DC = +0,000/-0,040
 DCON = h_6
 RE = +0,000/-0,050

>10-20 DIAMETER

DC = +0,000/-0,050
 DCON = h_6
 RE = +0,000/-0,050

- STEELS
- STAINLESS STEELS
- CAST IRON
- HIGH TEMP ALLOYS
- TITANIUM
- HARDENED STEELS

For patent information visit www.kspatents.com

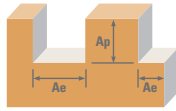

Series 33MCR Metric	Hardness	Ae x DC	Ap x DC	Vc (m/min)	DC • mm									
					3	6	8	10	12	16	20			
P CARBON STEELS 1018, 1040, 1080, 1090, 10L50, 1140, 1212, 12L15, 1525, 1536	≤ 275 Bhn or ≤ 28 HRc	Profile 	≤ 0.5	≤ 1.5	168	RPM	17773	8886	6665	5332	4443	3332	2666	
					(134-201)	Fz	0.012	0.029	0.049	0.061	0.074	0.100	0.107	
					Feed (mm/min)	640	768	981	981	992	998	853		
		Slot 	1	≤ 1	134	RPM	14218	7109	5332	4265	3555	2666	2133	
					(107-161)	Fz	0.012	0.029	0.049	0.061	0.074	0.100	0.107	
					Feed (mm/min)	512	614	785	785	793	798	682		
	M ALLOY STEELS 4140, 4150, 4320, 5120, 5150, 8630, 86L20, 50100	≤ 375 Bhn or ≤ 40 HRc	Profile 	≤ 0.5	≤ 1.5	96	RPM	10179	5089	3817	3054	2545	1909	1527
						(77-115)	Fz	0.010	0.022	0.036	0.045	0.055	0.074	0.080
						Feed (mm/min)	293	330	415	415	421	425	366	
			Slot 	1	≤ 1	76	RPM	8078	4039	3029	2424	2020	1515	1212
						(61-91)	Fz	0.010	0.022	0.036	0.045	0.055	0.074	0.080
						Feed (mm/min)	233	262	330	330	334	337	291	
K STAINLESS STEELS (FREE MACHINING) 303, 416, 420F, 430F, 440F		≤ 275 Bhn or ≤ 28 HRc	Profile 	≤ 0.5	≤ 1.5	149	RPM	15834	7917	5938	4750	3958	2969	2375
						(119-179)	Fz	0.009	0.024	0.041	0.051	0.060	0.079	0.085
						Feed (mm/min)	433	570	722	722	712	707	608	
			Slot 	1	≤ 1	119	RPM	12602	6301	4726	3781	3151	2363	1890
						(95-143)	Fz	0.009	0.024	0.041	0.051	0.060	0.079	0.085
						Feed (mm/min)	345	454	575	575	567	563	484	
	K STAINLESS STEELS (DIFFICULT) 304, 304L, 316, 316L	≤ 275 Bhn or ≤ 28 HRc	Profile 	≤ 0.5	≤ 1.5	104	RPM	10987	5493	4120	3296	2747	2060	1648
						(83-124)	Fz	0.007	0.019	0.032	0.040	0.048	0.064	0.069
						Feed (mm/min)	237	316	396	396	395	396	343	
			Slot 	1	≤ 1	82	RPM	8725	4362	3272	2617	2181	1636	1309
						(66-99)	Fz	0.007	0.019	0.032	0.040	0.048	0.064	0.069
						Feed (mm/min)	188	251	314	314	314	314	272	
K STAINLESS STEELS (PH) 13-8 PH, 15-5 PH, 17-4 PH, Custom 450		≤ 325 Bhn or ≤ 35 HRc	Profile 	≤ 0.5	≤ 1.5	94	RPM	10017	5009	3756	3005	2504	1878	1503
						(76-113)	Fz	0.007	0.019	0.032	0.040	0.048	0.064	0.069
						Feed (mm/min)	216	288	361	361	361	361	313	
			Slot 	1	≤ 1	76	RPM	8078	4039	3029	2424	2020	1515	1212
						(61-91)	Fz	0.007	0.019	0.032	0.040	0.048	0.064	0.069
						Feed (mm/min)	174	233	291	291	291	291	252	
	K CAST IRONS (LOW & MEDIUM ALLOY) Gray, Malleable, Ductile	≤ 220 Bhn or ≤ 19 HRc	Profile 	≤ 0.5	≤ 1.5	136	RPM	14380	7190	5392	4314	3595	2696	2157
						(109-163)	Fz	0.008	0.026	0.045	0.056	0.067	0.090	0.096
						Feed (mm/min)	362	569	725	725	725	725	621	
			Slot 	1	≤ 1	108	RPM	11471	5736	4302	3441	2868	2151	1721
						(87-130)	Fz	0.008	0.026	0.045	0.056	0.067	0.090	0.096
						Feed (mm/min)	289	454	578	578	578	578	496	

continued on next page

Series 33

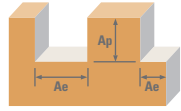

Series 33MCR Metric	Hardness	Ae x DC	Ap x DC	Vc (m/min)	DC • mm									
					3	6	8	10	12	16	20			
K CAST IRONS (HIGH ALLOY) Gray, Malleable, Ductile	≤ 260 Bhn or ≤ 26 HRC	Profile 	≤ 0.5	≤ 1.5	104	RPM	10987	5493	4120	3296	2747	2060	1648	
					(83-124)	Fz	0.007	0.019	0.034	0.043	0.050	0.067	0.072	
						Feed (mm/min)	237	316	422	422	415	411	356	
		Slot 	1	≤ 1	82	RPM	8725	4362	3272	2617	2181	1636	1309	
					(66-99)	Fz	0.007	0.019	0.034	0.043	0.050	0.067	0.072	
						Feed (mm/min)	188	251	335	335	330	327	283	
	S SUPER ALLOYS (NICKEL, COBALT, IRON BASE) Inconel 601, 617, 625, Incoloy, Monel 400	≤ 300 Bhn or ≤ 32 HRC	Profile 	≤ 0.5	≤ 1.5	24	RPM	2585	1293	969	776	646	485	388
						(20-29)	Fz	0.006	0.017	0.028	0.035	0.041	0.054	0.059
							Feed (mm/min)	48	65	81	65	79	78	68
			Slot 	1	≤ 1	20	RPM	2100	1050	788	630	525	394	315
						(16-24)	Fz	0.006	0.017	0.028	0.035	0.041	0.054	0.059
							Feed (mm/min)	39	53	66	66	64	64	55
≤ 400 Bhn or ≤ 43 HRC		Profile 	≤ 0.5	≤ 1.5	19	RPM	2003	1002	751	601	501	376	301	
					(15-23)	Fz	0.005	0.012	0.019	0.024	0.029	0.038	0.043	
						Feed (mm/min)	29	36	43	43	43	43	38	
		Slot 	1	≤ 1	15	RPM	1583	792	594	475	396	297	238	
					(12-18)	Fz	0.005	0.012	0.019	0.024	0.029	0.038	0.043	
						Feed (mm/min)	23	28	34	34	34	34	30	
TITANIUM ALLOYS Pure Titanium, Ti6Al4V, Ti6Al2Sn4Zr2Mo, Ti4Al4Mo2Sn0.5Si	≤ 350 Bhn or ≤ 38 HRC	Profile 	≤ 0.5	≤ 1.5	66	RPM	6947	3474	2605	2084	1737	1303	1042	
					(52-79)	Fz	0.007	0.019	0.032	0.040	0.048	0.064	0.069	
						Feed (mm/min)	150	200	250	250	250	250	217	
		Slot 	1	≤ 1	52	RPM	5493	2747	2060	1648	1373	1030	824	
					(41-62)	Fz	0.007	0.019	0.032	0.040	0.048	0.064	0.069	
						Feed (mm/min)	119	158	198	198	198	198	171	
	≤ 440 Bhn or ≤ 47 HRC	Profile 	≤ 0.5	≤ 1.5	23	RPM	2424	1212	909	727	606	454	364	
					(18-27)	Fz	0.007	0.019	0.032	0.040	0.048	0.064	0.069	
						Feed (mm/min)	52	70	87	87	87	87	76	
		Slot 	1	≤ 1	18	RPM	1939	969	727	582	485	364	291	
					(15-22)	Fz	0.007	0.019	0.032	0.040	0.048	0.064	0.069	
						Feed (mm/min)	42	56	70	70	70	70	60	
H TOOL STEELS A2, D2, H13, L2, M2, P20, S7, T15, W2	≤ 375 Bhn or ≤ 40 HRC	Profile 	≤ 0.5	≤ 1.5	56	RPM	5978	2989	2242	1793	1495	1121	897	
					(45-68)	Fz	0.007	0.017	0.030	0.037	0.043	0.059	0.064	
						Feed (mm/min)	129	151	201	201	194	198	172	
		Slot 	1	≤ 1	44	RPM	4686	2343	1757	1406	1171	879	703	
					(35-53)	Fz	0.007	0.017	0.030	0.037	0.043	0.059	0.064	
						Feed (mm/min)	101	118	157	157	152	155	135	

Bhn (Brinell) HRC (Rockwell C)
 rpm = (Vc x 1000) / (DC x 3.14)
 mm/min = Fz x 3 x rpm
 reduce speed and feed for materials harder than listed
 reduce feed and Ae when finish milling (.02 x DC maximum)
 feed rates listed have chip thinning adjustments included where applicable
 refer to the SGS Tool Wizard® for complete technical information (www.kyocera-sgstool.com)



7
FRACTIONAL SERIES

TOLERANCES (inch)

DC = +0.0000/-0.0020
DCON = h₆

- STEELS
- STAINLESS STEELS
- CAST IRON
- HIGH TEMP ALLOYS
- TITANIUM
- HARDENED STEELS

For patent information visit www.kspatents.com

inch				EDP NO.
CUTTING DIAMETER DC	LENGTH OF CUT APMX	OVERALL LENGTH LF	SHANK DIAMETER DCON	Ti-NAMITE-X
1/8	3/4	2-1/4	1/8	70470
1/8	1	3	1/8	70471
3/16	3/4	2-1/2	3/16	70472
3/16	1-1/8	3	3/16	70473
1/4	1-1/8	3	1/4	70474
1/4	1-1/2	4	1/4	70475
5/16	1-1/8	3	5/16	70476
5/16	1-5/8	4	5/16	70477
3/8	1-1/8	3	3/8	70478
3/8	1-3/4	4	3/8	70479
7/16	2	4-1/2	7/16	70480
7/16	3	6	7/16	70481
1/2	2	4-1/2	1/2	70482
1/2	3	6	1/2	70483
5/8	2-1/4	5	5/8	70484
5/8	3	6	5/8	70485
3/4	2-1/4	5	3/4	70486
3/4	3	6	3/4	70487
1	2-1/4	5	1	70488
1	3	6	1	70489

- Variable pitch allows for improved chatter suppression along with improved surface finish and enhanced tool life
- Raised land and increased core diameter designed to enhance tool life and decrease tool deflection
- Recommended for materials ≤ 45 HRc (≤ 420 Bhn)



7M
METRIC SERIES

TOLERANCES (mm)

DC = +0,000/+0,050
DCON = h₆

- STEELS
- STAINLESS STEELS
- CAST IRON
- HIGH TEMP ALLOYS
- TITANIUM
- HARDENED STEELS

For patent information visit www.kspatents.com

mm				EDP NO.
CUTTING DIAMETER DC	LENGTH OF CUT APMX	OVERALL LENGTH LF	SHANK DIAMETER DCON	Ti-NAMITE-X
3,0	25,0	75,0	3,0	70551
4,0	25,0	75,0	4,0	70552
5,0	25,0	75,0	5,0	70553
6,0	25,0	75,0	6,0	70554
8,0	25,0	75,0	8,0	70555
10,0	38,0	100,0	10,0	70556
12,0	50,0	100,0	12,0	70557
12,0	75,0	150,0	12,0	70558
14,0	75,0	150,0	14,0	70559
16,0	75,0	150,0	16,0	70560
18,0	75,0	150,0	18,0	70561
20,0	75,0	150,0	20,0	70562
25,0	75,0	150,0	25,0	70563

- Variable pitch allows for improved chatter suppression along with improved surface finish and enhanced tool life
- Raised land and increased core diameter designed to enhance tool life and decrease tool deflection
- Recommended for materials ≤ 45 HRc (≤ 420 Bhn)

Series 7



7B FRACTIONAL SERIES

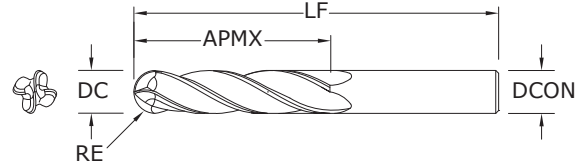

- Variable pitch allows for improved chatter suppression along with improved surface finish and enhanced tool life
- Raised land and increased core diameter designed to enhance tool life and decrease tool deflection
- Ball nose design ideal for finishing operations in complex workpieces
- Recommended for materials ≤ 45 HRc (≤ 420 Bhn)

inch				EDP NO.
CUTTING DIAMETER DC	LENGTH OF CUT APMX	OVERALL LENGTH LF	SHANK DIAMETER DCON	Ti-NAMITE-X
1/8	3/4	2-1/4	1/8	70441
1/8	1	3	1/8	70442
3/16	3/4	2-1/2	3/16	70444
3/16	1-1/8	3	3/16	70445
1/4	1-1/8	3	1/4	70447
1/4	1-1/2	4	1/4	70448
5/16	1-1/8	3	5/16	70450
5/16	1-5/8	4	5/16	70451
3/8	1-1/8	3	3/8	70453
3/8	1-3/4	4	3/8	70454
7/16	2	4-1/2	7/16	70456
7/16	3	6	7/16	70457
1/2	2	4-1/2	1/2	70459
1/2	3	6	1/2	70460
5/8	2-1/4	5	5/8	70462
5/8	3	6	5/8	70463
3/4	2-1/4	5	3/4	70465
3/4	3	6	3/4	70466
1	2-1/4	5	1	70468
1	3	6	1	70469

RE = 1/2 Cutting Diameter (DC)

TOLERANCES (inch)
 DC = +0.0000/-0.0020
 DCON = h_6
 RE = +0.0000/-0.0010

- STEELS
- STAINLESS STEELS
- CAST IRON
- HIGH TEMP ALLOYS
- TITANIUM
- HARDENED STEELS

For patent information visit www.ksptpatents.com

7MB METRIC SERIES

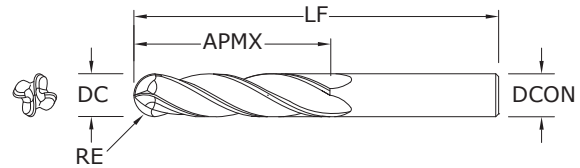

- Variable pitch allows for improved chatter suppression along with improved surface finish and enhanced tool life
- Raised land and increased core diameter designed to enhance tool life and decrease tool deflection
- Ball nose design ideal for finishing operations in complex workpieces
- Recommended for materials ≤ 45 HRc (≤ 420 Bhn)

mm				EDP NO.
CUTTING DIAMETER DC	LENGTH OF CUT APMX	OVERALL LENGTH LF	SHANK DIAMETER DCON	Ti-NAMITE-X
3,0	25,0	75,0	3,0	70527
4,0	25,0	75,0	4,0	70529
5,0	25,0	75,0	5,0	70531
6,0	25,0	75,0	6,0	70533
8,0	25,0	75,0	8,0	70535
10,0	38,0	100,0	10,0	70537
12,0	50,0	100,0	12,0	70539
12,0	75,0	150,0	12,0	70540
14,0	75,0	150,0	14,0	70542
16,0	75,0	150,0	16,0	70544
18,0	75,0	150,0	18,0	70546
20,0	75,0	150,0	20,0	70548
25,0	75,0	150,0	25,0	70550

RE = 1/2 Cutting Diameter (DC)

TOLERANCES (mm)
 DC = +0,000/+0,050
 DCON = h_6
 RE = +0,000/-0,025

- STEELS
- STAINLESS STEELS
- CAST IRON
- HIGH TEMP ALLOYS
- TITANIUM
- HARDENED STEELS

For patent information visit www.ksptpatents.com

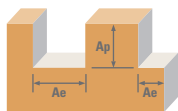

Series	7, 7B	Hardness	Finish	Ae x DC	Ap x DC	Vc (sfm)	DC • in							
							1/8	1/4	3/8	1/2	5/8	3/4	1	
P	CARBON STEELS 1018, 1040, 1080, 1090, 10L50, 1140, 1212, 12L15, 1525, 1536	≤ 275 Bhn or ≤ 28 HRc		≤ 0.02	≤ 2	480	RPM	14669	7334	4890	3667	2934	2445	1834
		(384-576)				Fz	0.0004	0.0010	0.0019	0.0025	0.0032	0.0033	0.0035	
		Feed (ipm)				23.5	29.3	37.2	36.7	37.6	32.3	25.7		
P	ALLOY STEELS 4140, 4150, 4320, 5120, 5150, 8630, 86L20, 50100	≤ 375 Bhn or ≤ 40 HRc		≤ 0.02	≤ 2	275	RPM	8404	4202	2801	2101	1681	1401	1051
		(220-330)				Fz	0.0003	0.0007	0.0014	0.0018	0.0023	0.0024	0.0026	
		Feed (ipm)				10.1	11.8	15.7	15.1	15.5	13.4	10.9		
M	STAINLESS STEELS (FREE MACHINING) 303, 416, 420F, 430F, 440F	≤ 275 Bhn or ≤ 28 HRc		≤ 0.02	≤ 2	420	RPM	12835	6418	4278	3209	2567	2139	1604
		(336-504)				Fz	0.0004	0.0010	0.0019	0.0025	0.0032	0.0033	0.0035	
		Feed (ipm)				20.5	25.7	32.5	32.1	32.9	28.2	22.5		
M	STAINLESS STEELS (DIFFICULT) 304, 304L, 316, 316L	≤ 275 Bhn or ≤ 28 HRc		≤ 0.02	≤ 2	290	RPM	8862	4431	2954	2216	1772	1477	1108
		(232-348)				Fz	0.0003	0.0007	0.0014	0.0018	0.0023	0.0024	0.0026	
		Feed (ipm)				10.6	12.4	16.5	16.0	16.3	14.2	11.5		
M	STAINLESS STEELS (PH) 13-8 PH, 15-5 PH, 17-4 PH, Custom 450	≤ 325 Bhn or ≤ 35 HRc		≤ 0.02	≤ 2	265	RPM	8098	4049	2699	2025	1620	1350	1012
		(212-318)				Fz	0.0003	0.0007	0.0014	0.0018	0.0023	0.0024	0.0026	
		Feed (ipm)				9.7	11.3	15.1	14.6	14.9	13.0	10.5		
K	CAST IRONS (LOW & MEDIUM ALLOY) Gray, Malleable, Ductile	≤ 220 Bhn or ≤ 19 HRc		≤ 0.02	≤ 2	605	RPM	18489	9244	6163	4622	3698	3081	2311
		(484-726)				Fz	0.0006	0.0015	0.0028	0.0037	0.0046	0.0047	0.0051	
		Feed (ipm)				44.4	55.5	69.0	68.4	68.0	57.9	47.1		
K	CAST IRONS (HIGH ALLOY) Gray, Malleable, Ductile	≤ 260 Bhn or ≤ 26 HRc		≤ 0.02	≤ 2	465	RPM	14210	7105	4737	3553	2842	2368	1776
		(372-558)				Fz	0.0004	0.0011	0.0021	0.0028	0.0034	0.0036	0.0039	
		Feed (ipm)				22.7	31.3	39.8	39.8	38.7	34.1	27.7		
S	SUPER ALLOYS (NICKEL, COBALT, IRON BASE) Inconel 601, 617, 625, Incoloy, Monel 400	≤ 300 Bhn or ≤ 32 HRc		≤ 0.02	≤ 2	80	RPM	2445	1222	815	611	489	407	306
		(64-96)				Fz	0.0003	0.0007	0.0014	0.0018	0.0023	0.0024	0.0026	
		Feed (ipm)				2.9	3.4	4.6	4.4	4.5	3.9	3.2		
S	SUPER ALLOYS (NICKEL, COBALT, IRON BASE) Inconel 718, X-750, Incoloy, Waspaloy, Hastelloy, Rene	≤ 400 Bhn or ≤ 43 HRc		≤ 0.02	≤ 2	65	RPM	1986	993	662	497	397	331	248
		(52-78)				Fz	0.0002	0.0006	0.0010	0.0014	0.0017	0.0018	0.0019	
		Feed (ipm)				1.6	2.4	2.6	2.8	2.7	2.4	1.9		
S	TITANIUM ALLOYS Pure Titanium, Ti6Al4V, Ti6Al2Sn4Zr2Mo, Ti4Al4Mo2Sn0.5Si	≤ 350 Bhn or ≤ 38 HRc		≤ 0.02	≤ 2	300	RPM	9168	4584	3056	2292	1834	1528	1146
		(240-360)				Fz	0.0004	0.0011	0.0021	0.0028	0.0034	0.0036	0.0039	
		Feed (ipm)				14.7	20.2	25.7	25.7	24.9	22.0	17.9		
S	TITANIUM ALLOYS (DIFFICULT) Ti10Al2Fe3Al, Ti5Al5V5Mo3Cr, Ti7Al4Mo, Ti3Al8V6Cr4Zr4Mo, Ti6Al6V6Sn, Ti15V3 Cr3Sn3Al	≤ 440 Bhn or ≤ 47 HRc		≤ 0.02	≤ 2	105	RPM	3209	1604	1070	802	642	535	401
		(84-126)				Fz	0.0004	0.0011	0.0021	0.0028	0.0034	0.0036	0.0039	
		Feed (ipm)				5.1	7.1	9.0	9.0	8.7	7.7	6.3		
H	TOOL STEELS A2, D2, H13, L2, M2, P20, S7, T15, W2	≤ 375 Bhn or ≤ 40 HRc		≤ 0.02	≤ 2	230	RPM	7029	3514	2343	1757	1406	1171	879
		(184-276)				Fz	0.0002	0.0006	0.0012	0.0016	0.0020	0.0021	0.0022	
		Feed (ipm)				5.6	8.4	11.2	11.2	11.2	9.8	7.7		

Bhn (Brinell) HRc (Rockwell C)
 $rpm = Vc \times 3.82 / DC$
 $ipm = Fz \times 4 \times rpm$
 reduce speed and feed for materials harder than listed
 feed rates listed have chip thinning adjustments included where applicable
 refer to the SGS Tool Wizard® for complete technical information (www.kyocera-sgtool.com)

Series 7

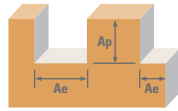

Series 7M, 7MB Metric	Hardness	Finish	Ae x DC	Ap x DC	Vc (m/min)	DC • mm									
						3	6	8	10	12	16	20	25		
P	CARBON STEELS 1018, 1040, 1080, 1090, 10L50, 1140, 1212, 12L15, 1525, 1536	≤ 275 Bhn or ≤ 28 HRc	Finish	≤ 0.02	≤ 2	146	RPM	15511	7755	5816	4653	3878	2908	2327	1861
						(117-176)	Fz	0.0166	0.043	0.075	0.093	0.110	0.125	0.147	0.160
						Feed (mm/min)	1030	1334	1745	1731	1706	1454	1368	1191	
ALLOY STEELS 4140, 4150, 4320, 5120, 5150, 8630, 86L20, 50100	≤ 375 Bhn or ≤ 40 HRc	Finish	≤ 0.02	≤ 2	84	RPM	8886	4443	3332	2666	2222	1666	1333	1066	
						(67-101)	Fz	0.0122	0.034	0.051	0.069	0.082	0.091	0.109	0.120
						Feed (mm/min)	434	604	680	736	729	606	581	512	
M	STAINLESS STEELS (FREE MACHINING) 303, 416, 420F, 430F, 440F	≤ 275 Bhn or ≤ 28 HRc	Finish	≤ 0.02	≤ 2	128	RPM	13572	6786	5089	4072	3393	2545	2036	1629
						(102-154)	Fz	0.0086	0.024	0.040	0.048	0.058	0.065	0.077	0.087
						Feed (mm/min)	467	651	814	782	787	662	627	567	
STAINLESS STEELS (DIFFICULT) 304, 304L, 316, 316L	≤ 275 Bhn or ≤ 28 HRc	Finish	≤ 0.02	≤ 2	88	RPM	9371	4686	3514	2811	2343	1757	1406	1125	
						(71-106)	Fz	0.0082	0.022	0.037	0.045	0.048	0.060	0.072	0.078
						Feed (mm/min)	307	412	520	506	450	422	405	351	
STAINLESS STEELS (PH) 13-8 PH, 15-5 PH, 17-4 PH, Custom 450	≤ 325 Bhn or ≤ 35 HRc	Finish	≤ 0.02	≤ 2	81	RPM	8563	4282	3211	2569	2141	1606	1284	1028	
						(65-97)	Fz	0.0070	0.019	0.029	0.040	0.048	0.055	0.064	0.070
						Feed (mm/min)	240	325	372	411	411	353	329	288	
K	CAST IRONS (LOW & MEDIUM ALLOY) Gray, Malleable, Ductile	≤ 220 Bhn or ≤ 19 HRc	Finish	≤ 0.02	≤ 2	184	RPM	19550	9775	7331	5865	4887	3666	2932	2346
						(148-221)	Fz	0.0132	0.036	0.052	0.075	0.089	0.099	0.117	0.130
						Feed (mm/min)	1032	1408	1525	1759	1740	1452	1372	1220	
CAST IRONS (HIGH ALLOY) Gray, Malleable, Ductile	≤ 260 Bhn or ≤ 26 HRc	Finish	≤ 0.02	≤ 2	142	RPM	15026	7513	5635	4508	3756	2817	2254	1803	
						(113-170)	Fz	0.0132	0.036	0.052	0.075	0.089	0.099	0.117	0.130
						Feed (mm/min)	793	1082	1172	1352	1337	1116	1055	938	
S	SUPER ALLOYS (NICKEL, COBALT, IRON BASE) Inconel 601, 617, 625, Incoloy, Monel 400	≤ 300 Bhn or ≤ 32 HRc	Finish	≤ 0.02	≤ 2	24	RPM	2585	1293	969	776	646	485	388	310
						(20-29)	Fz	0.0072	0.019	0.029	0.037	0.046	0.053	0.061	0.085
						Feed (mm/min)	74	98	112	90	119	103	95	105	
SUPER ALLOYS (NICKEL, COBALT, IRON BASE) Inconel 718, X-750, Incoloy, Waspaloy, Hastelloy, Rene	≤ 400 Bhn or ≤ 43 HRc	Finish	≤ 0.02	≤ 2	20	RPM	2100	1050	788	630	525	394	315	252	
						(16-24)	Fz	0.0075	0.016	0.021	0.030	0.038	0.044	0.051	0.070
						Feed (mm/min)	63	67	66	76	80	69	64	71	
TITANIUM ALLOYS Pure Titanium, Ti6Al4V, Ti6Al2Sn4Zr2Mo, Ti4Al4Mo2Sn0.5Si	≤ 350 Bhn or ≤ 38 HRc	Finish	≤ 0.02	≤ 2	91	RPM	9694	4847	3635	2908	2424	1818	1454	1163	
						(73-110)	Fz	0.0091	0.024	0.040	0.050	0.060	0.070	0.080	0.088
						Feed (mm/min)	353	465	51	59	582	509	465	409	
TITANIUM ALLOYS (DIFFICULT) Ti10Al2Fe3Al, Ti5Al5V5Mo3Cr, Ti7Al4Mo, Ti3Al8V6Cr4Zr4Mo, Ti6Al6V6Sn, Ti15V3 Cr3Sn3Al	≤ 440 Bhn or ≤ 47 HRc	Finish	≤ 0.02	≤ 2	32	RPM	3393	1696	1272	1018	848	636	509	407	
						(26-38)	Fz	0.0082	0.019	0.029	0.037	0.046	0.053	0.061	0.085
						Feed (mm/min)	111	129	148	151	156	135	124	138	
H	TOOL STEELS A2, D2, H13, L2, M2, P20, S7, T15, W2	≤ 375 Bhn or ≤ 40 HRc	Finish	≤ 0.02	≤ 2	70	RPM	7432	3716	2787	2230	1858	1394	1115	892
						(56-84)	Fz	0.0070	0.019	0.040	0.043	0.048	0.057	0.064	0.070
						Feed (mm/min)	208	282	446	384	357	318	285	250	

Bhn (Brinell) HRc (Rockwell C)

$$\text{rpm} = (\text{Vc} \times 1000) / (\text{DC} \times 3.14)$$

$$\text{mm/min} = \text{Fz} \times 4 \times \text{rpm}$$

reduce speed and feed for materials harder than listed

feed rates listed have chip thinning adjustments included where applicable

refer to the SGS Tool Wizard® for complete technical information (www.kyocera-sgstool.com)

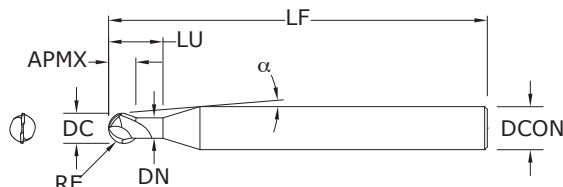
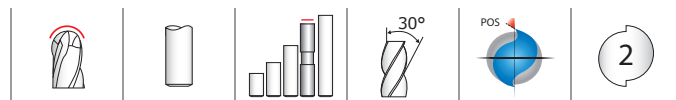

56B
FRACTIONAL SERIES

TOLERANCES (inch)

1/32–3/32 DIAMETER

DC = +0.0000/–0.0010

DCON = h_6

RE = +0.0000/–0.0005

>3/32–1/4 DIAMETER

DC = +0.0000/–0.0012

DCON = h_6

RE = +0.0000/–0.0006

>1/4–3/8 DIAMETER

DC = +0.0000/–0.0016

DCON = h_6

RE = +0.0000/–0.0008

>3/8–3/4 DIAMETER

DC = +0.0000/–0.0020

DCON = h_6

RE = +0.0000/–0.0010

HARDENED STEELS

For patent information visit www.ksptpatents.com

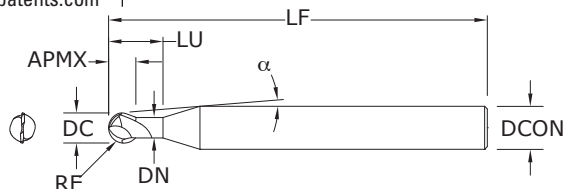

56MB
METRIC SERIES

TOLERANCES (mm)

1–2,5 DIAMETER

DC = +0,000/–0,025

DCON = h_6

RE = +0,000/–0,0013

>2,5–6 DIAMETER

DC = +0,000/–0,030

DCON = h_6

RE = +0,000/–0,0013

>6–10 DIAMETER

DC = +0,000/–0,040

DCON = h_6

RE = +0,000/–0,0020

>10–20 DIAMETER

DC = +0,000/–0,050

DCON = h_6

RE = +0,000/–0,0025

HARDENED STEELS

For patent information visit www.ksptpatents.com

	inch							EDP NO.
	CUTTING DIAMETER DC	LENGTH OF CUT APMX	OVERALL LENGTH LF	SHANK DIAMETER DCON	CENTER LINE ANGLE α	REACH LU	NECK DIAMETER DN	Ti-NAMITE-X
	1/32	1/32	3	1/4	8°20'	1/16	.025	93272
	1/16	1/16	3	1/4	7°40'	1/8	.055	93273
	3/32	3/32	3	1/4	6°50'	3/16	.085	93274
	1/8	1/8	3	1/4	6°	1/4	.114	93275
	3/16	3/16	3	1/4	3°35'	3/8	.171	93276
	1/4	1/4	3-1/2	1/4	–	1/2	.230	93277
	5/16	5/16	4	5/16	–	5/8	.292	93278
	3/8	3/8	4	3/8	–	3/4	.355	93279
	1/2	1/2	4-1/2	1/2	–	1	.480	93280
	5/8	5/8	5-1/2	5/8	–	1-1/4	.610	93281
	3/4	3/4	6-1/2	3/4	–	1-1/2	.735	93282

Neck Option Available
RE = 1/2 Cutting Diameter (DC)

- Short flute length and rigid design to reduce deflection
- S-Gash Ball geometry minimizes load and heat produced during the cutting process, ultimately enhancing tool life
- Ideal for machining complex contoured shapes in hardened steels
- Recommended for materials 35 to 60 HRc (327 to 654 Bhn)

	mm							EDP NO.
	CUTTING DIAMETER DC	LENGTH OF CUT APMX	OVERALL LENGTH LF	SHANK DIAMETER DCON	CENTER LINE ANGLE α	REACH LU	NECK DIAMETER DN	Ti-NAMITE-X
	1,0	1,0	76,0	6,0	8°10'	2,0	0,91	91349
	1,5	1,5	76,0	6,0	7°45'	3,0	1,37	91350
	2,0	2,0	76,0	6,0	7°10'	4,0	1,83	91351
	2,5	2,5	76,0	6,0	6°35'	5,0	2,29	91352
	3,0	3,0	76,0	6,0	6°	6,0	2,72	91353
	4,0	4,0	76,0	6,0	4°30'	8,0	3,63	91354
	5,0	5,0	89,0	6,0	2°30'	10,0	4,55	91355
	6,0	6,0	89,0	6,0	–	12,0	5,49	91356
	8,0	8,0	102,0	8,0	–	16,0	7,49	91357
	10,0	10,0	102,0	10,0	–	20,0	9,47	91358
	12,0	12,0	114,0	12,0	–	24,0	11,48	91359
	16,0	16,0	140,0	16,0	–	32,0	15,62	91360
	20,0	20,0	165,0	20,0	–	40,0	19,61	91361

Neck Option Available
RE = 1/2 Cutting Diameter (DC)

- Short flute length and rigid design to reduce deflection
- S-Gash Ball geometry minimizes load and heat produced during the cutting process, ultimately enhancing tool life
- Ideal for machining complex contoured shapes in hardened steels
- Recommended for materials 35 to 60 HRc (327 to 654 Bhn)

Turbo-Carb

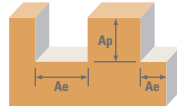

Series 56B Fractional	Hardness	Ae x DC	Ap x DC	Vc (sfm)	DC • in									
					1/32	1/16	1/8	3/16	1/4	3/8	1/2	3/4		
H	TOOL STEELS MOLD AND DIE STEEL 300M, 4340, 52100, HP-9-4-20, M50, A2, D2, H13, L2, M2, P20, S7, T15, W2 ≤ 375 Bhn or ≤ 40 HRc	Rough 	≤ 0.4	≤ 0.1	625	RPM	76400	38200	19100	12733	9550	6367	4775	3183
					(500-750)	Fz	0.0006	0.0015	0.0030	0.0040	0.0050	0.0080	0.0100	0.0120
					Feed (ipm)	92	115	115	102	96	102	96	76	
		HSM 	≤ 0.4	≤ 0.03	950	RPM	116128	58064	29032	19355	14516	9677	7258	4839
					(760-1140)	Fz	0.0007	0.0017	0.0033	0.0044	0.0060	0.0088	0.0110	0.0130
					Feed (ipm)	163	197	192	170	174	170	160	126	
	TOOL STEELS MOLD AND DIE STEEL 300M, 4340, 52100, HP-9-4-20, M50, A2, D2, H13, L2, M2, P20, S7, T15, W2 ≤ 475 Bhn or ≤ 50 HRc	Rough 	≤ 0.4	≤ 0.05	750	RPM	91680	45840	22920	15280	11460	7640	5730	3820
					(600-900)	Fz	0.0005	0.0011	0.0023	0.0030	0.0038	0.0060	0.0075	0.0085
					Feed (ipm)	92	101	105	92	87	92	86	65	
		HSM 	≤ 0.4	≤ 0.02	1150	RPM	140576	70288	35144	23429	17572	11715	8786	5857
					(920-1380)	Fz	0.0006	0.0012	0.0025	0.0033	0.0042	0.0066	0.0082	0.0100
					Feed (ipm)	169	169	176	155	148	155	144	117	
TOOL STEELS MOLD AND DIE STEEL 300M, 4340, 52100, HP-9-4-20, M50, A2, D2, H13, L2, M2, P20, S7, T15, W2 ≤ 655 Bhn or ≤ 60 HRc	Rough 	≤ 0.4	≤ 0.04	500	RPM	61120	30560	15280	10187	7640	5093	3820	2547	
				(400-600)	Fz	0.0004	0.0008	0.0017	0.0023	0.0029	0.0045	0.0057	0.0063	
				Feed (ipm)	49	49	52	47	44	46	44	32		
	HSM 	≤ 0.4	≤ 0.01	1000	RPM	122240	61120	30560	20373	15280	10187	7640	5093	
				(800-1200)	Fz	0.0005	0.0009	0.0019	0.0025	0.0032	0.0050	0.0063	0.0071	
				Feed (ipm)	122	110	116	102	98	102	96	72		

Bhn (Brinell) HRc (Rockwell C) HSM (High Speed Machining)
 rpm = Vc x 3.82 / DC
 ipm = Fz x 2 x rpm
 reduce speed and feed for materials harder than listed
 reduce feed and Ae when finish milling (.02 x DC maximum)
 feed rates listed have chip thinning adjustments included where applicable
 refer to the SGS Tool Wizard® for complete technical information (www.kyocera-sgstool.com)

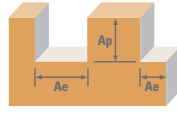

Series 56MB Metric	Hardness	Ae x DC	Ap x DC	Vc (m/min)	DC • mm									
					1	1.5	3	5	6	10	12	20		
TOOL STEELS MOLD AND DIE STEEL 300M, 4340, 52100, HP-9-4-20, M50, A2, D2, H13, L2, M2, P20, S7, T15, W2	≤ 375 Bhn or ≤ 40 HRc	Rough 	≤ 0.4	≤ 0.1	191	RPM	60748	40498	20249	12150	10125	6075	5062	3037
					(153-229)	Fz	0.015	0.038	0.076	0.102	0.127	0.203	0.254	0.305
					Feed (mm/min)	1822	3078	3078	2479	2572	2466	2572	1853	
		HSM 	≤ 0.4	≤ 0.03	290	RPM	92235	61490	46117	18447	15372	9223	7686	4612
					(232-348)	Fz	0.018	0.043	0.084	0.112	0.117	0.224	0.279	0.330
					Feed (mm/min)	3320	5288	7748	4132	3597	4132	4289	3044	
	≤ 475 Bhn or ≤ 50 HRc	Rough 	≤ 0.4	≤ 0.05	229	RPM	72833	48556	24278	14567	12139	7283	6069	3642
					(183-275)	Fz	0.013	0.028	0.058	0.076	0.097	0.152	0.191	0.216
					Feed (mm/min)	1894	2719	2816	2214	2355	2214	2319	1573	
		HSM 	≤ 0.4	≤ 0.02	351	RPM	111636	74424	37212	22327	18606	11164	9303	5582
					(281-421)	Fz	0.015	0.030	0.064	0.084	0.107	0.168	0.208	0.254
					Feed (mm/min)	3349	4465	4763	3751	3982	3751	3870	2836	
≤ 655 Bhn or ≤ 60 HRc	Rough 	≤ 0.4	≤ 0.04	152	RPM	48344	32229	16115	9669	8057	4834	4029	2417	
				(122-182)	Fz	0.010	0.020	0.043	0.058	0.074	0.114	0.145	0.160	
				Feed (mm/min)	967	1289	1386	1122	1192	1102	1168	773		
	HSM 	≤ 0.4	≤ 0.01	305	RPM	97005	64670	32335	19401	16168	9701	8084	4850	
				(244-366)	Fz	0.013	0.023	0.048	0.064	0.081	0.127	0.160	0.180	
				Feed (mm/min)	2522	2975	3104	2483	2619	2464	2587	1746		

Bhn (Brinell) HRc (Rockwell C) HSM (High Speed Machining)
 $rpm = (Vc \times 1000) / (DC \times 3.14)$
 $mm/min = Fz \times 2 \times rpm$
 reduce speed and feed for materials harder than listed
 reduce feed and Ae when finish milling (.02 x DC maximum)
 feed rates listed have chip thinning adjustments included where applicable
 refer to the SGS Tool Wizard® for complete technical information (www.kyocera-sgstool.com)

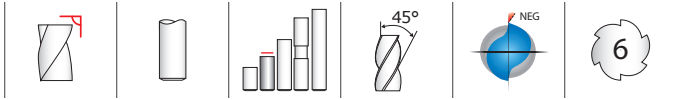

57

FRACTIONAL SERIES

- Ideal in Trochoidal milling applications in hardened steels and dry machining
- Short flute length and large core design to reduce deflection
- Unsurpassed edge strength with extreme negative rake and eccentric relief
- Recommended for materials 45 to 65 HRc (421 to 739 Bhn)

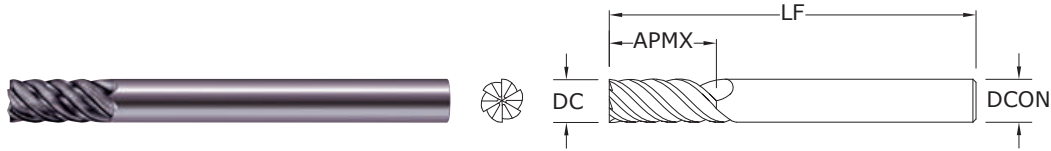

inch				EDP NO.
CUTTING DIAMETER DC	LENGTH OF CUT APMX	OVERALL LENGTH LF	SHANK DIAMETER DCON	Ti-NAMITE-X
1/4	17/32	3-1/2	1/4	36140
5/16	11/16	4	5/16	36141
3/8	13/16	4	3/8	36142
1/2	1-3/32	4-1/2	1/2	36143

Neck Option Available

TOLERANCES (inch)

- 1/4 DIAMETER**
DC = +0.0000/-0.0012
DCON = h₆
- 5/16 DIAMETER**
DC = +0.0000/-0.0016
DCON = h₆
- 3/8 DIAMETER**
DC = +0.0000/-0.0016
DCON = h₆
- 1/2 DIAMETER**
DC = +0.0000/-0.0020
DCON = h₆

HARDENED STEELS

For patent information visit www.ksptpatents.com

57M

METRIC SERIES

- Ideal in Trochoidal milling applications in hardened steels and dry machining
- Short flute length and large core design to reduce deflection
- Unsurpassed edge strength with extreme negative rake and eccentric relief
- Recommended for materials 45 to 65 HRc (421 to 739 Bhn)

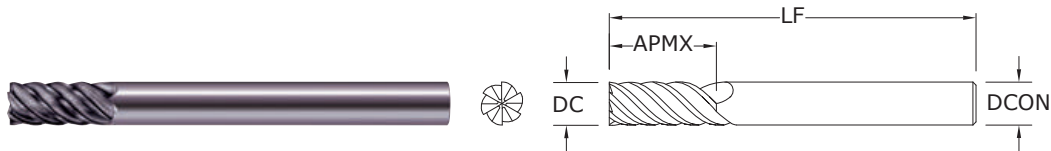

mm				EDP NO.
CUTTING DIAMETER DC	LENGTH OF CUT APMX	OVERALL LENGTH LF	SHANK DIAMETER DCON	Ti-NAMITE-X
6,0	13,0	89,0	6,0	46140
8,0	18,0	102,0	8,0	46141
10,0	22,0	102,0	10,0	46142
12,0	26,0	114,0	12,0	46143
16,0	32,0	140,0	16,0	46145
20,0	38,0	165,0	20,0	46147

Neck Option Available





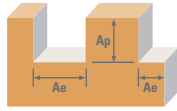

TOLERANCES (mm)

- 6 DIAMETER**
DC = +0,000/-0,030
DCON = h₆
- 8 DIAMETER**
DC = +0,000/-0,040
DCON = h₆
- 10 DIAMETER**
DC = +0,000/-0,040
DCON = h₆
- 12-20 DIAMETER**
DC = +0,000/-0,050
DCON = h₆

HARDENED STEELS

For patent information visit www.ksptpatents.com



Series 57 Fractional	Hardness	Ae x DC	Ap x DC	Vc (sfm)	DC • in											
					1/4	5/16	3/8	1/2								
TOOL STEELS MOLD AND DIE STEEL 300M, 4340, 52100, HP-9-4-20, M50, A2, D2, H13, L2, M2, P20, S7, T15, W2	≤ 420 Bhn or ≤ 45 HRc	Slot 	1	≤ 0.3	215	RPM	3285	2628	2190	1643						
					(172-258)	Fz	0.0013	0.0019	0.0025	0.0031						
						Feed (ipm)	26	30	33	31						
					265	RPM	4049	3239	2699	2025						
					(212-318)	Fz	0.0018	0.0026	0.0035	0.0044						
						Feed (ipm)	44	51	57	53						
	HSM	≤ 0.04	HSM 	≤ 0.04	≤ 1.5	560	RPM	8557	6845	5705	4278					
						(448-672)	Fz	0.0022	0.0033	0.0044	0.0055					
							Feed (ipm)	113	136	151	141					
						TOOL STEELS MOLD AND DIE STEEL 300M, 4340, 52100, HP-9-4-20, M50, A2, D2, H13, L2, M2, P20, S7, T15, W2	≤ 560 Bhn or ≤ 55 HRc	Slot 	1	≤ 0.3	120	RPM	1834	1467	1222	917
											(96-144)	Fz	0.0010	0.0015	0.0020	0.0025
												Feed (ipm)	11	13	15	14
150	RPM	2292	1834	1528	1146											
(120-180)	Fz	0.0014	0.0021	0.0028	0.0035											
	Feed (ipm)	19	23	26	24											
HSM	≤ 0.04	HSM 	≤ 0.04	≤ 1.5	490		RPM	7487	5990	4991	3744					
					(392-588)		Fz	0.0018	0.0026	0.0035	0.0044					
							Feed (ipm)	81	93	105	99					
					TOOL STEELS MOLD AND DIE STEEL 300M, 4340, 52100, HP-9-4-20, M50, A2, D2, H13, L2, M2, P20, S7, T15, W2		≤ 740 Bhn or ≤ 65 HRc	Slot 	1	≤ 0.3	65	RPM	993	795	662	497
											(52-78)	Fz	0.0008	0.0011	0.0015	0.0019
												Feed (ipm)	5	5	6	6
80	RPM	1222	978	815		611										
(64-96)	Fz	0.0011	0.0016	0.0021		0.0026										
	Feed (ipm)	8	9	10		10										
HSM	≤ 0.04	HSM 	≤ 0.04	≤ 1.5		250	RPM	3820	3056	2547	1910					
						(200-300)	Fz	0.0013	0.0019	0.0025	0.0031					
							Feed (ipm)	30	35	38	36					

Bhn (Brinell) HRc (Rockwell C) HSM (High Speed Machining)
 rpm = Vc x 3.82 / DC
 ipm = Fz x 6 x rpm
 reduce speed and feed for materials harder than listed
 reduce feed and Ae when finish milling (.02 x DC maximum)
 feed rates listed have chip thinning adjustments included where applicable
 refer to the SGS Tool Wizard® for complete technical information (www.kyocera-sgstool.com)

Power-Carb®

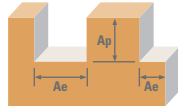

Series 57M	Metric	Hardness	Ae x DC	Ap x DC	Vc (m/min)	DC • mm										
						6	8	10	12	16	20					
TOOL STEELS MOLD AND DIE STEEL 300M, 4340, 52100, HP-9-4-20, M50, A2, D2, H13, L2, M2, P20, S7, T15, W2	Slot	≤ 420 Bhn or ≤ 45 HRc	1	≤ 0.3	66	RPM	3499	2624	2099	1749	1312	1050				
					(53-79)	Fz	0.032	0.048	0.064	0.079	0.094	0.109				
						Feed (mm/min)	672	756	806	829	740	686				
					81	RPM	4294	3220	2576	2147	1610	1288				
					(65-97)	Fz	0.046	0.066	0.089	0.112	0.132	0.152				
						Feed (mm/min)	1185	1275	1376	1443	1275	1175				
	HSM	≤ 0.04	≤ 1.5	171	RPM	9064	6798	5439	4532	3399	2719					
				(137-205)	Fz	0.056	0.084	0.112	0.140	0.170	0.200					
					Feed (mm/min)	3046	3426	3655	3807	3467	3263					
				TOOL STEELS MOLD AND DIE STEEL 300M, 4340, 52100, HP-9-4-20, M50, A2, D2, H13, L2, M2, P20, S7, T15, W2	Slot	≤ 560 Bhn or ≤ 55 HRc	1	≤ 0.3	37	RPM	1961	1471	1177	981	735	588
									(30-44)	Fz	0.025	0.038	0.051	0.064	0.077	0.090
										Feed (mm/min)	294	335	360	377	340	318
46	RPM	2438	1829						1463	1219	914	732				
(37-55)	Fz	0.036	0.053						0.071	0.089	0.107	0.125				
	Feed (mm/min)	527	582						623	651	587	549				
HSM	≤ 0.04	≤ 1.5	149	RPM	7898	5924	4739	3949	2962	2369						
			(119-179)	Fz	0.046	0.066	0.089	0.112	0.135	0.158						
				Feed (mm/min)	2180	2346	2531	2654	2399	2246						
			TOOL STEELS MOLD AND DIE STEEL 300M, 4340, 52100, HP-9-4-20, M50, A2, D2, H13, L2, M2, P20, S7, T15, W2	Slot	≤ 740 Bhn or ≤ 65 HRc	1	≤ 0.3	20	RPM	1060	795	636	530	398	318	
								(16-24)	Fz	0.020	0.028	0.038	0.048	0.058	0.068	
									Feed (mm/min)	127	134	145	153	138	130	
24	RPM	1272						954	763	636	477	382				
(19-29)	Fz	0.028						0.041	0.053	0.066	0.078	0.090				
	Feed (mm/min)	214						235	243	252	223	206				
HSM	≤ 0.04	≤ 1.5	76	RPM	4029	3021	2417	2014	1511	1209						
			(61-91)	Fz	0.033	0.048	0.064	0.079	0.094	0.109						
				Feed (mm/min)	798	870	928	955	852	790						

Bhn (Brinell) HRc (Rockwell C) HSM (High Speed Machining)
 rpm = (Vc x 1000) / (DC x 3.14)
 mm/min = Fz x 6 x rpm
 reduce speed and feed for materials harder than listed
 reduce feed and Ae when finish milling (.02 x DC maximum)
 feed rates listed have chip thinning adjustments included where applicable
 refer to the SGS Tool Wizard® for complete technical information (www.kyocera-sgstool.com)

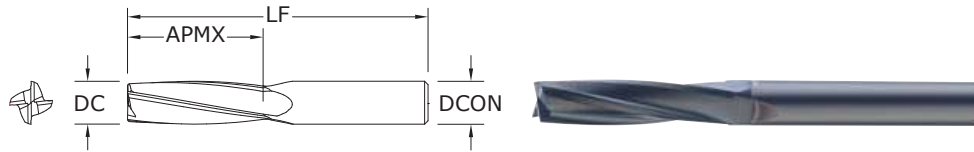

27
FRACTIONAL SERIES

TOLERANCES (inch)

DC = +0.0000/-0.0030
DCON = h₆

PLASTICS/COMPOSITES

For patent information visit www.ksptpatents.com

CUTTING DIAMETER DC	LENGTH OF CUT APMX	OVERALL LENGTH LF	SHANK DIAMETER DCON	EDP NO.	
				UNCOATED	Di-NAMITE® (Diamond)
1/4	1	2-1/2	1/4	72978	72979
3/8	1-1/8	2-1/2	3/8	72980	72981
1/2	1-1/2	3-1/2	1/2	72982	72983
3/4	1-3/8	4	3/4	72984	72985

- Slow helix design adds strength to the edge allowing ease for milling highly abrasive materials
- Two levels of chatter suppression: variable helix and indexing
- Excels at roughing (slotting, profiling) and finishing in a variety of plastics and composites

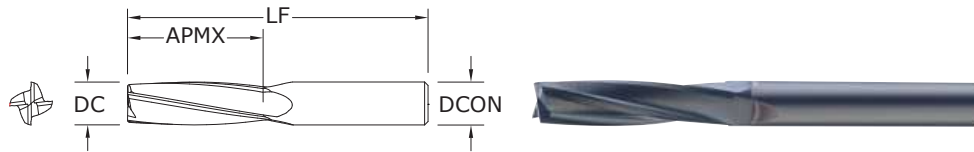

27M
METRIC SERIES

TOLERANCES (mm)

DC = +0,000/-0,080
DCON = h₆

PLASTICS/COMPOSITES

For patent information visit www.ksptpatents.com

CUTTING DIAMETER DC	LENGTH OF CUT APMX	OVERALL LENGTH LF	SHANK DIAMETER DCON	EDP NO.	
				UNCOATED	Di-NAMITE® (Diamond)
6,0	25,0	63,0	6,0	83056	83057
8,0	25,0	63,0	8,0	83058	83059
10,0	28,0	63,0	10,0	83060	83061
12,0	38,0	89,0	12,0	83062	83063
16,0	48,0	115,0	16,0	83064	83065

- Slow helix design adds strength to the edge allowing ease for milling highly abrasive materials
- Two levels of chatter suppression: variable helix and indexing
- Excels at roughing (slotting, profiling) and finishing in a variety of plastics and composites

FRACTIONAL Series 27

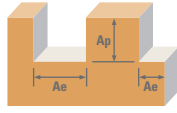

Series 27 Fractional			Vc (sfm)	DC • in				
	Ae x DC	Ap x DC		1/4	3/8	1/2	3/4	
CFRP, AFRP (CARBON FIBER, ARAMID FIBER)	Slot 	1 ≤ 1	400	RPM	6112	4075	3056	2037
			(320-480)	Fz	0.0016	0.0030	0.0040	0.0048
				Feed (ipm)	39	49	49	39
	Profile 	≤ 0.5 ≤ 1.5	500	RPM	7640	5093	3820	2547
			(400-600)	Fz	0.0016	0.0030	0.0040	0.0048
				Feed (ipm)	49	61	61	49
	HSM 	≤ 0.5 ≤ 2	825	RPM	12606	8404	6303	4202
			(660-990)	Fz	0.0037	0.0069	0.0092	0.0110
				Feed (ipm)	187	232	232	185
GFRP (FIBERGLASS)	Slot 	1 ≤ 1	320	RPM	4890	3260	2445	1630
			(256-384)	Fz	0.0016	0.0030	0.0040	0.0048
				Feed (ipm)	31	39	39	31
	Profile 	≤ 0.5 ≤ 1.5	400	RPM	6112	4075	3056	2037
			(320-480)	Fz	0.0016	0.0030	0.0040	0.0048
				Feed (ipm)	39	49	49	39
	HSM 	≤ 0.5 ≤ 2	660	RPM	10085	6723	5042	3362
			(528-792)	Fz	0.0037	0.0069	0.0092	0.0110
				Feed (ipm)	149	186	186	148
N CARBON, GRAPHITE	Slot 	1 ≤ 1	480	RPM	7334	4890	3667	2445
			(384-576)	Fz	0.0020	0.0038	0.0050	0.0060
				Feed (ipm)	59	74	73	59
	Profile 	≤ 0.5 ≤ 1.5	600	RPM	9168	6112	4584	3056
			(480-720)	Fz	0.0020	0.0038	0.0050	0.0060
				Feed (ipm)	73	93	92	73
	HSM 	≤ 0.5 ≤ 2	990	RPM	15127	10085	7564	5042
			(792-1188)	Fz	0.0046	0.0086	0.0115	0.0138
				Feed (ipm)	278	347	348	278
PLASTICS	Slot 	1 ≤ 1	800	RPM	12224	8149	6112	4075
			(640-690)	Fz	0.0020	0.0038	0.0050	0.0060
				Feed (ipm)	98	124	122	98
	Profile 	≤ 0.5 ≤ 1.5	1000	RPM	15280	10187	7640	5093
			(800-1200)	Fz	0.0020	0.0038	0.0050	0.0060
				Feed (ipm)	122	155	153	122
	HSM 	≤ 0.5 ≤ 2	1650	RPM	25212	16808	12606	8404
			(1320-1980)	Fz	0.0046	0.0086	0.0115	0.0138
				Feed (ipm)	464	578	580	464
MACHINABLE CERAMICS MACHINABLE GLASS	Slot 	1 ≤ 1	40	RPM	611	407	306	204
			(32-48)	Fz	0.0008	0.0015	0.0020	0.0024
				Feed (ipm)	2.0	2.4	2.4	2.0
	Profile 	≤ 0.5 ≤ 1.5	50	RPM	764	509	382	255
			(40-60)	Fz	0.0008	0.0015	0.0020	0.0024
				Feed (ipm)	2.4	3.1	3.1	2.4
	HSM 	≤ 0.5 ≤ 2	85	RPM	1299	866	649	433
			(68-102)	Fz	0.0018	0.0034	0.0046	0.0055
				Feed (ipm)	9.4	11.8	11.9	9.5

HSM (High Speed Machining)
 $rpm = Vc \times 3.82 / DC$
 $ipm = Fz \times 4 \times rpm$
 adjust parameters based on resin type and fiber structure
 reduce speed when overheating causes melting or damage to resin
 reduce feed if delamination or fraying occur
 finish cuts typically required reduced feed and cutting depths

rates shown are for use without coolant; rates may be increased with coolant
 dust collection is vital when machining dry
 diamond coating will increase tool life in graphite and composite materials
 feed rates listed have chip thinning adjustments included where applicable
 refer to the SGS Tool Wizard® for complete technical information
 (www.kyocera-sgstool.com)

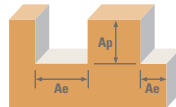

Series 27M Metric	Ae x DC	Ap x DC	Vc (m/min)	DC • mm						
				6	8	10	12	16		
CFRP, AFRP (CARBON FIBER, ARAMID FIBER)	Slot 	1	≤ 1	120	RPM	6361	4771	3817	3181	2385
				(96-164)	Fz	0.040	0.065	0.075	0.100	0.120
				Feed (mm/min)	1018	1240	1145	1272	1145	
	Profile 	≤ 0.5	≤ 1.5	150	RPM	7951	5963	4771	3976	2982
				(120-180)	Fz	0.040	0.065	0.075	0.100	0.120
				Feed (mm/min)	1272	1550	1431	1590	1431	
	HSM 	≤ 0.5	≤ 2	250	RPM	13252	9939	7951	6626	4970
				(200-300)	Fz	0.095	0.145	0.175	0.235	0.280
				Feed (mm/min)	5036	5765	5566	6228	5566	
GFRP (FIBERGLASS)	Slot 	1	≤ 1	100	RPM	5301	3976	3181	2650	1988
				(80-120)	Fz	0.040	0.065	0.075	0.100	0.120
				Feed (mm/min)	848	1034	954	1060	954	
	Profile 	≤ 0.5	≤ 1.5	120	RPM	6361	4771	3817	3181	2385
				(96-164)	Fz	0.040	0.065	0.075	0.100	0.120
				Feed (mm/min)	1018	1240	1145	1272	1145	
	HSM 	≤ 0.5	≤ 2	200	RPM	10602	7951	6361	5301	3976
				(160-240)	Fz	0.095	0.145	0.175	0.235	0.280
				Feed (mm/min)	4029	4612	4453	4983	4453	
N CARBON, GRAPHITE	Slot 	1	≤ 1	145	RPM	7686	5765	4612	3843	2882
				(116-174)	Fz	0.050	0.080	0.095	0.125	0.150
				Feed (mm/min)	1537	1845	1752	1922	1729	
	Profile 	≤ 0.5	≤ 1.5	185	RPM	9807	7355	5884	4903	3677
				(148-222)	Fz	0.050	0.080	0.095	0.125	0.150
				Feed (mm/min)	1961	2354	2236	2452	2206	
	HSM 	≤ 0.5	≤ 2	300	RPM	15903	11927	9542	7951	5963
				(240-360)	Fz	0.115	0.185	0.220	0.290	0.350
				Feed (mm/min)	7315	8826	8397	9223	8349	
PLASTICS	Slot 	1	≤ 1	245	RPM	12987	9740	7792	6494	4870
				(196-294)	Fz	0.050	0.080	0.095	0.125	0.150
				Feed (mm/min)	2597	3117	2961	3247	2922	
	Profile 	≤ 0.5	≤ 1.5	305	RPM	16168	12126	9701	8084	6063
				(244-366)	Fz	0.050	0.080	0.095	0.125	0.150
				Feed (mm/min)	3234	3880	3686	4042	3638	
	HSM 	≤ 0.5	≤ 2	505	RPM	26769	20077	16062	13385	10038
				(404-606)	Fz	0.115	0.185	0.220	0.290	0.350
				Feed (mm/min)	12314	14857	14134	15526	14054	
MACHINABLE CERAMICS MACHINABLE GLASS	Slot 	1	≤ 1	10	RPM	530	398	318	265	199
				(8-12)	Fz	0.020	0.035	0.045	0.050	0.060
				Feed (mm/min)	42	56	57	53	48	
	Profile 	≤ 0.5	≤ 1.5	15	RPM	795	596	477	398	298
				(12-18)	Fz	0.020	0.035	0.045	0.050	0.060
				Feed (mm/min)	64	83	86	80	72	
	HSM 	≤ 0.5	≤ 2	25	RPM	1325	994	795	663	497
				(20-30)	Fz	0.045	0.075	0.085	0.115	0.140
				Feed (mm/min)	239	298	270	305	278	

HSM (High Speed Machining)
 $rpm = Vc \times 3.82 / DC$
 $mm/min = Fz \times 4 \times rpm$
 adjust parameters based on resin type and fiber structure
 reduce speed when overheating causes melting or damage to resin
 reduce feed if delamination or fraying occur
 finish cuts typically require reduced feed and cutting depths

rates shown are for use without coolant; rates may be increased with coolant
 dust collection is vital when machining dry
 diamond coating will increase tool life in graphite and composite materials
 feed rates listed have chip thinning adjustments included where applicable
 refer to the SGS Tool Wizard® for complete technical information
 (www.kyocera-sgstoool.com)

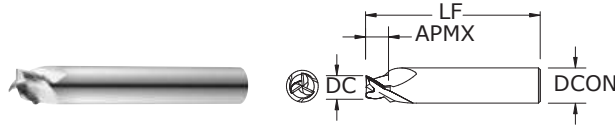
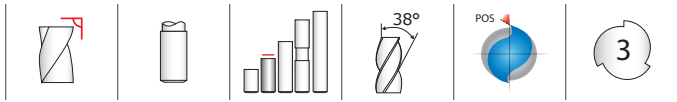

Non-Ferrous Recoil Groove Tool

FRACTIONAL SERIES

- Open Flute design improves chip removal at high feed rates.
- Circular land improves surface finish and chatter suppression.
- Symmetrical end gashing improves balance in high speed operations.
- 45 degree chamfer enables slot and deburr in one operation.
- Meets MIL-STD 1913.

CUTTING DIAMETER DC	inch			EDP NO.	
	SHANK DIAMETER DCON	LENGTH OF CUT APMX	OVERALL LENGTH LF	UNCOATED	Ti-NAMITE-B (TiB ₂)
0.2100	1/4	0.118	1-3/4	34760	34761

TOLERANCES (inch)

DC = +0.0080/-0.0000

APMX = +0.0060/-0.0000

DCON = h₆

NON-FERROUS

For patent information visit www.ksptpatents.com

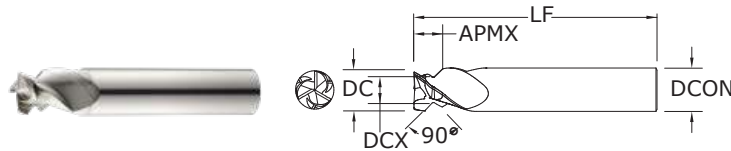
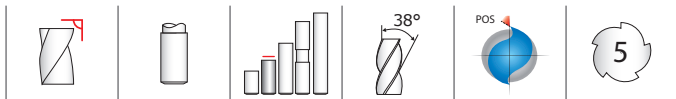

Non-Ferrous Dovetail Form Tool

FRACTIONAL SERIES

- Open Flute design improves chip removal at high feed rates.
- Specially engineered flute shape for improved chip control.
- Circular land improves surface finish and chatter suppression.
- Symmetrical end gashing improves balance in high speed operations.
- Meets MIL-STD 1913.

CUTTING DIAMETER DC	INNER CUTTING DIAMETER DCX	inch			EDP NO.	
		SHANK DIAMETER DCON	LENGTH OF CUT APMX	OVERALL LENGTH LF	UNCOATED	Ti-NAMITE-B (TiB ₂)
0.6050	0.384	5/8	0.410	3-1/2	34762	34763

TOLERANCES (inch)

DC = +0.0010/-0.0010

DCON = h₆

NON-FERROUS

For patent information visit www.ksptpatents.com

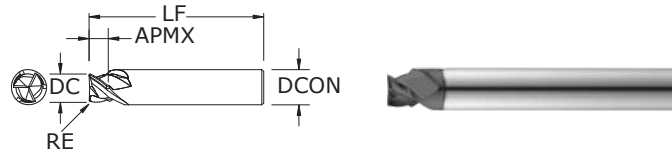
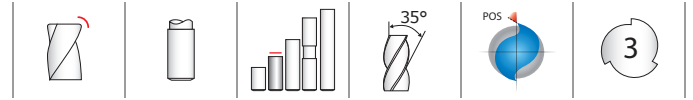

Ferrous Recoil Groove Tool

FRACTIONAL SERIES

TOLERANCES (inch)

DC = +0.0080/-0.0000

APMX = +0.0060/-0.0000

DCON = h_6

RE = +0.0000/-0.0005

- STEELS
- STAINLESS STEELS
- TITANIUM
- HARDENED STEELS

For patent information visit www.ksptpatents.com

CUTTING DIAMETER DC	SHANK DIAMETER DCON	inch			EDP NO.	
		LENGTH OF CUT APMX	OVERALL LENGTH LF	CORNER RADIUS RE	Ti-NAMITE-A (TA)	Ti-NAMITE-M (TM)
0.2100	1/4	0.118	1-3/4	.010	33360	33361

- Heavy core design adds rigidity for cutting difficult to machine materials.
- Tight corner radius tangency tolerance for quality recoil grooves.
- Specially engineered flute design adds strength and improves chip flow.
- Meets MIL-STD 1913.

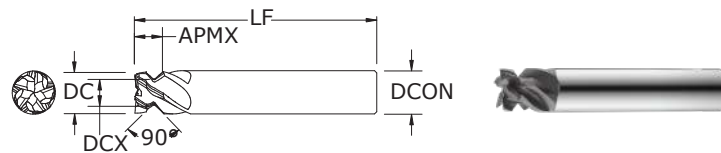
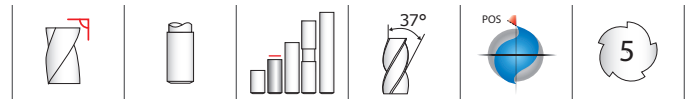

Ferrous Dovetail Form Tool

FRACTIONAL SERIES

TOLERANCES (inch)

DC = +0.0010/-0.0010

DCON = h_6

- STEELS
- STAINLESS STEELS
- TITANIUM
- HARDENED STEELS

For patent information visit www.ksptpatents.com







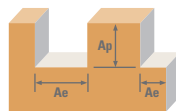



CUTTING DIAMETER DC	INNER CUTTING DIAMETER DCX	inch			EDP NO.	
		SHANK DIAMETER DCON	LENGTH OF CUT APMX	OVERALL LENGTH LF	Ti-NAMITE-A (TA)	Ti-NAMITE-M (TM)
0.6050	0.384	5/8	0.410	3-1/2	37391	37390

- Five-flute design allows for higher machining parameters.
- Open end work design allows for increased chip space.
- Square end configuration with enhanced corner strength to improve corner durability.
- Meets MIL-STD 1913.

Picatinny Rail Ferrous Recoil Groove Tool



Picatinny Rail
Ferrous Recoil Groove Tool
3 Flute
Made to MIL-STD-1913

			Hardness	Ae x DC	Ap x DC	Vc (sfm)	DC • in	
							0.2100	
P	CARBON STEELS 1018, 1040, 1080, 1090, 10L50, 1140, 1212, 12L15, 1525, 1536	≤ 275 Bhn or ≤ 28 HRc	Slot 	0.210	0.118	440 (352-528)	RPM	8004
							Fz	0.0009
							Feed (ipm)	22.99
M	ALLOY STEELS 4140, 4150, 4320, 5120, 5150, 8630, 86L20, 50100	≤ 375 Bhn or ≤ 40 HRc	Slot 	0.210	0.118	250 (200-300)	RPM	4548
							Fz	0.0006
							Feed (ipm)	9.79
M	STAINLESS STEELS (FREE MACHINING) 303, 416, 420F, 430F, 440F	≤ 275 Bhn or ≤ 28 HRc	Slot 	0.210	0.118	390 (312-468)	RPM	7094
							Fz	0.0007
							Feed (ipm)	17.01
M	STAINLESS STEELS (DIFFICULT) 304, 304L, 316, 316L	≤ 275 Bhn or ≤ 28 HRc	Slot 	0.210	0.118	270 (216-324)	RPM	4911
							Fz	0.0006
							Feed (ipm)	9.41
M	STAINLESS STEELS (PH) 13-8 PH, 15-5 PH, 17-4 PH, Custom 450	≤ 325 Bhn or ≤ 35 HRc	Slot 	0.210	0.118	250 (200-300)	RPM	4548
							Fz	0.0006
							Feed (ipm)	8.74
K	CAST IRONS (LOW & MEDIUM ALLOY) Gray, Malleable, Ductile	≤ 220 Bhn or ≤ 19 HRc	Slot 	0.210	0.118	270 (216-324)	RPM	4911
							Fz	0.0006
							Feed (ipm)	9.41
N	ALUMINUM ALLOYS 2017, 2024, 356, 6061, 7075 Tool not recommended for this material group							
	ALUMINUM DIE CAST ALLOYS (HIGH SILICONE) A-390, A-392, B-390 Tool not recommended for this material group							
	COPPER ALLOYS Alum Bronze, C110, Muntz Brass Tool not recommended for this material group							
S	PLASTICS Polycarbonate, PVC, Polypropylene Tool not recommended for this material group							
	SUPER ALLOYS (NICKEL, COBALT, IRON BASE) Inconel 601, 617, 625, Incoloy, Monel 400	≤ 300 Bhn or ≤ 32 HRc	Slot 	0.210	0.118	65 (52-78)	RPM	1182
							Fz	0.0005
Feed (ipm)							2.00	
S	SUPER ALLOYS (NICKEL, COBALT, IRON BASE) Inconel 718, X-750, Incoloy, Waspaloy, Hastelloy, Rene	≤ 400 Bhn or ≤ 43 HRc	Slot 	0.210	0.118	49 (39-59)	RPM	891
							Fz	0.0004
							Feed (ipm)	1.05
S	TITANIUM ALLOYS Pure Titanium, Ti6Al4V, Ti6Al2Sn4Zr2Mo, Ti4Al4Mo2Sn0.5Si	≤ 350 Bhn or ≤ 38 HRc	Slot 	0.210	0.118	170 (136-204)	RPM	3092
							Fz	0.0006
							Feed (ipm)	5.89
S	TITANIUM ALLOYS (DIFFICULT) Ti10Al2Fe3Al, Ti5Al5V5Mo3Cr, Ti7Al4Mo, Ti3Al8V6Cr4Zr4Mo, Ti6Al6V6Sn, Ti15V3 Cr3Sn3Al	≤ 440 Bhn or ≤ 47 HRc	Slot 	0.210	0.118	60 (48-72)	RPM	1091
							Fz	0.0006
							Feed (ipm)	2.09
H	TOOL STEELS A2, D2, H13, L2, M2, P20, S7, T15, W2	≤ 375 Bhn or ≤ 40 HRc	Slot 	0.210	0.118	145 (116-174)	RPM	2638
							Fz	0.0005
							Feed (ipm)	4.47

Bhn (Brinell) HRc (Rockwell C)
when recommended speed exceeds your capability, use maximum available and recalculate ipm
rpm = Vc x 3.82 / DC
ipm = Fz x 3 x rpm
reduce speed and feed for materials harder than listed
reduce feed and Ae when finish milling (.02 x DC maximum)
refer to the SGS Tool Wizard® for complete technical information (www.kyocera-sgstool.com)



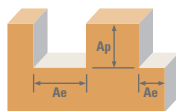

Picatinny Rail Non-Ferrous Recoil Groove Tool

Picatinny Rail
Non-Ferrous Recoil
Groove Tool
3 Flute
Made to MIL-STD-1913



DC • in

0.2100

	Hardness		Ae x DC	Ap x DC	Vc (sfm)		
P	CARBON STEELS 1018, 1040, 1080, 1090, 10L50, 1140, 1212, 12L15, 1525, 1536					Tool not recommended for this material group	
	ALLOY STEELS 4140, 4150, 4320, 5120, 5150, 8630, 86L20, 50100					Tool not recommended for this material group	
M	STAINLESS STEELS (FREE MACHINING) 303, 416, 420F, 430F, 440F					Tool not recommended for this material group	
	STAINLESS STEELS (DIFFICULT) 304, 304L, 316, 316L					Tool not recommended for this material group	
	STAINLESS STEELS (PH) 13-8 PH, 15-5 PH, 17-4 PH, Custom 450					Tool not recommended for this material group	
K	CAST IRONS (LOW & MEDIUM ALLOY) Gray, Malleable, Ductile					Tool not recommended for this material group	
N	ALUMINUM ALLOYS 2017, 2024, 356, 6061, 7075	≤ 150 Bhn or ≤ 7 HRc		0.210	0.118	1600 (1280-1920)	RPM 29105 Fz 0.0026 Feed (ipm) 227.89
	ALUMINUM DIE CAST ALLOYS (HIGH SILICONE) A-390, A-392, B-390	≤ 125 Bhn or ≤ 77 HRb		0.210	0.118	600 (480-720)	RPM 10914 Fz 0.0026 Feed (ipm) 85.46
	COPPER ALLOYS Alum Bronze, C110, Muntz Brass	≤ 140 Bhn or ≤ 3 HRc		0.210	0.118	345 (276-414)	RPM 6276 Fz 0.0022 Feed (ipm) 40.79
	PLASTICS Polycarbonate, PVC, Polypropylene			0.210	0.118	1600 (1280-1920)	RPM 29105 Fz 0.0044 Feed (ipm) 380.58
	SUPER ALLOYS (NICKEL, COBALT, IRON BASE) Inconel 601, 617, 625, Incoloy, Monel 400						Tool not recommended for this material group
S	SUPER ALLOYS (NICKEL, COBALT, IRON BASE) Inconel 718, X-750, Incoloy, Waspaloy, Hastelloy, Rene					Tool not recommended for this material group	
	TITANIUM ALLOYS Pure Titanium, Ti6Al4V, Ti6Al2Sn4Zr2Mo, Ti4Al4Mo2Sn0.5Si					Tool not recommended for this material group	
	TITANIUM ALLOYS (DIFFICULT) Ti10Al2Fe3Al, Ti5Al5V5Mo3Cr, Ti7Al4Mo, Ti3Al8V6Cr4Zr4Mo, Ti6Al6V6Sn, Ti15V3 Cr3Sn3Al						Tool not recommended for this material group
H	TOOL STEELS A2, D2, H13, L2, M2, P20, S7, T15, W2					Tool not recommended for this material group	

Bhn (Brinell) HRc (Rockwell C)
when recommended speed exceeds your capability, use maximum available and recalculate ipm
rpm = Vc x 3.82 / DC
ipm = Fz x 3 x rpm
reduce speed and feed for materials harder than listed
reduce feed and Ae when finish milling (.02 x DC maximum)
refer to the SGS Tool Wizard® for complete technical information (www.kyocera-sgstool.com)

Picatinny Rail Ferrous Dovetail Form Tool

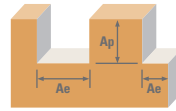

Picatinny Rail
Ferrous Dovetail Form Tool
5 Flute
Made to MIL-STD-1913

		Hardness			Vc (sfm)	DC • in		
			Ae x DC	Ap x DC		0.6050		
P	CARBON STEELS 1018, 1040, 1080, 1090, 10L50, 1140, 1212, 12L15, 1525, 1536	≤ 275 Bhn or ≤ 28 HRc	Profile 	≤ .50	APMX	450 (360-540)	RPM	2841
		Fz					0.0032	
		Feed (ipm)					46.03	
M	ALLOY STEELS 4140, 4150, 4320, 5120, 5150, 8630, 86L20, 50100	≤ 375 Bhn or ≤ 40 HRc	Profile 	≤ .50	APMX	260 (208-312)	RPM	1642
		Fz					0.0024	
		Feed (ipm)					19.68	
M	STAINLESS STEELS (FREE MACHINING) 303, 416, 420F, 430F, 440F	≤ 275 Bhn or ≤ 28 HRc	Profile 	≤ .50	APMX	400 (320-480)	RPM	2526
		Fz					0.0024	
		Feed (ipm)					30.28	
M	STAINLESS STEELS (DIFFICULT) 304, 304L, 316, 316L	≤ 275 Bhn or ≤ 28 HRc	Profile 	≤ .50	APMX	280 (224-336)	RPM	1768
		Fz					0.0019	
		Feed (ipm)					16.61	
M	STAINLESS STEELS (PH) 13-8 PH, 15-5 PH, 17-4 PH, Custom 450	≤ 325 Bhn or ≤ 35 HRc	Profile 	≤ .50	APMX	260 (208-312)	RPM	1642
		Fz					0.0019	
		Feed (ipm)					15.42	
K	CAST IRONS (LOW & MEDIUM ALLOY) Gray, Malleable, Ductile	≤ 220 Bhn or ≤ 19 HRc	Profile 	≤ .50	APMX	280 (224-336)	RPM	1768
		Fz					0.0029	
		Feed (ipm)					25.78	
N	ALUMINUM ALLOYS 2017, 2024, 356, 6061, 7075	Tool not recommended for this material group						
		ALUMINUM DIE CAST ALLOYS (HIGH SILICONE) A-390, A-392, B-390	Tool not recommended for this material group					
			COPPER ALLOYS Alum Bronze, C110, Muntz Brass	Tool not recommended for this material group				
N	PLASTICS Polycarbonate, PVC, Polypropylene	Tool not recommended for this material group						
		S	SUPER ALLOYS (NICKEL, COBALT, IRON BASE) Inconel 601, 617, 625, Incoloy, Monel 400	≤ 300 Bhn or ≤ 32 HRc	Profile 	≤ .50	APMX	75 (60-90)
Fz	0.0018							
Feed (ipm)	4.22							
S	SUPER ALLOYS (NICKEL, COBALT, IRON BASE) Inconel 718, X-750, Incoloy, Waspaloy, Hastelloy, Rene	≤ 400 Bhn or ≤ 43 HRc	Profile 	≤ .50	APMX	60 (48-72)	RPM	379
		Fz					0.0013	
		Feed (ipm)					2.39	
S	TITANIUM ALLOYS Pure Titanium, Ti6Al4V, Ti6Al2Sn4Zr2Mo, Ti4Al4Mo2Sn0.5Si	≤ 350 Bhn or ≤ 38 HRc	Profile 	≤ .50	APMX	180 (144-216)	RPM	1137
		Fz					0.0021	
		Feed (ipm)					11.97	
S	TITANIUM ALLOYS (DIFFICULT) Ti10Al2Fe3Al, Ti5Al5V5Mo3Cr, Ti7Al4Mo, Ti3Al8V6Cr4Zr4Mo, Ti6Al6V6Sn, Ti15V3 Cr3Sn3Al	≤ 440 Bhn or ≤ 47 HRc	Profile 	≤ .50	APMX	70 (56-84)	RPM	442
		Fz					0.0021	
		Feed (ipm)					4.65	
H	TOOL STEELS A2, D2, H13, L2, M2, P20, S7, T15, W2	≤ 375 Bhn or ≤ 40 HRc	Profile 	≤ .50	APMX	145 (116-174)	RPM	916
		Fz					0.0019	
		Feed (ipm)					8.60	

Bhn (Brinell) HRc (Rockwell C)
when recommended speed exceeds your capability, use maximum available and recalculate ipm
rpm = Vc x 3.82 / DC
ipm = Fz x 5 x rpm
reduce speed and feed for materials harder than listed
reduce feed and Ae when finish milling (.02 x DC maximum)
refer to the SGS Tool Wizard® for complete technical information (www.kyocera-sgstool.com)



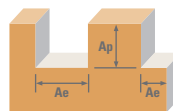

Picatinny Rail Non-Ferrous Dovetail Form Tool

Picatinny Rail
Non-Ferrous Dovetail
Form Tool
3 Flute
Made to MIL-STD-1913



DC • in

0.6050

	Hardness		Ae x DC	Ap x DC	Vc (sfm)		
P	CARBON STEELS 1018, 1040, 1080, 1090, 10L50, 1140, 1212, 12L15, 1525, 1536					Tool not recommended for this material group	
	ALLOY STEELS 4140, 4150, 4320, 5120, 5150, 8630, 86L20, 50100					Tool not recommended for this material group	
M	STAINLESS STEELS (FREE MACHINING) 303, 416, 420F, 430F, 440F					Tool not recommended for this material group	
	STAINLESS STEELS (DIFFICULT) 304, 304L, 316, 316L					Tool not recommended for this material group	
	STAINLESS STEELS (PH) 13-8 PH, 15-5 PH, 17-4 PH, Custom 450					Tool not recommended for this material group	
K	CAST IRONS (LOW & MEDIUM ALLOY) Gray, Malleable, Ductile					Tool not recommended for this material group	
N	ALUMINUM ALLOYS 2017, 2024, 356, 6061, 7075	≤ 150 Bhn or ≤ 7 HRc	Profile 	≤ .50	APMX	2000 (1600-2400)	RPM 12628 Fz 0.0056 Feed (ipm) 211.39
	ALUMINUM DIE CAST ALLOYS (HIGH SILICONE) A-390, A-392, B-390	≤ 125 Bhn or ≤ 77 HRb	Profile 	≤ .50	APMX	750 (600-900)	RPM 4736 Fz 0.0056 Feed (ipm) 79.27
	COPPER ALLOYS Alum Bronze, C110, Muntz Brass	≤ 140 Bhn or ≤ 3 HRc	Profile 	≤ .50	APMX	430 (344-516)	RPM 2715 Fz 0.0046 Feed (ipm) 37.72
	PLASTICS Polycarbonate, PVC, Polypropylene		Profile 	≤ .50	APMX	2000 (1600-2400)	RPM 12628 Fz 0.0093 Feed (ipm) 353.03
	SUPER ALLOYS (NICKEL, COBALT, IRON BASE) Inconel 601, 617, 625, Incoloy, Monel 400						Tool not recommended for this material group
S	SUPER ALLOYS (NICKEL, COBALT, IRON BASE) Inconel 718, X-750, Incoloy, Waspaloy, Hastelloy, Rene					Tool not recommended for this material group	
	TITANIUM ALLOYS Pure Titanium, Ti6Al4V, Ti6Al2Sn4Zr2Mo, Ti4Al4Mo2Sn0.5Si					Tool not recommended for this material group	
	TITANIUM ALLOYS (DIFFICULT) Ti10Al2Fe3Al, Ti5Al5V5Mo3Cr, Ti7Al4Mo, Ti3Al8V6Cr4Zr4Mo, Ti6Al6V6Sn, Ti15V3 Cr3Sn3Al						Tool not recommended for this material group
H	TOOL STEELS A2, D2, H13, L2, M2, P20, S7, T15, W2					Tool not recommended for this material group	

Bhn (Brinell) HRc (Rockwell C)
when recommended speed exceeds your capability, use maximum available and recalculate ipm
rpm = Vc x 3.82 / DC
ipm = Fz x 3 x rpm
reduce speed and feed for materials harder than listed
reduce feed and Ae when finish milling (.02 x DC maximum)
refer to the SGS Tool Wizard® for complete technical information (www.kyocera-sgstool.com)

High Performance Aluminum End Mills



Milling

HIGH PERFORMANCE ALUMINUM END MILLS	SERIES	DESCRIPTION	PAGE	
S-Carb APR® & APF®	43APR-3	3 Flute Advanced Productivity Rougher Fractional	127	
	43APR-3	3 Flute Advanced Productivity Rougher Metric	129	
	43APR-4	4 Flute Advanced Productivity Rougher Metric	130	
	43APF	4 Flute Advanced Productivity Finisher Fractional	132	
	43MAPF	4 Flute Advanced Productivity Finisher Metric	134	
S-Carb® (3 Flute)	43	3 Flute Non-Ferrous Square End Fractional	136	
	43CR	3 Flute Non-Ferrous Corner Radius Fractional	136	
	43L	3 Flute Non-Ferrous Square End Long Reach Fractional	140	
	43LC	3 Flute Non-Ferrous Corner Radius End Long Reach Fractional	140	
	43EC	3 Flute Non-Ferrous Square End Extra Long Reach Fractional	143	
	43B	3 Flute Non-Ferrous Ball End Fractional	144	
	43LB	3 Flute Non-Ferrous Ball End Long Reach Fractional	145	
	43EB	3 Flute Non-Ferrous Ball End Extra Long Reach Fractional	145	
	43M	3 Flute Non-Ferrous Square End Metric (Unpolished Flutes)	149	
	43M	3 Flute Non-Ferrous Square End Metric (Polished Flutes)	149	
	43MCR	3 Flute Non-Ferrous Corner Radius Metric (Unpolished Flutes)	149	
	43MCR	3 Flute Non-Ferrous Corner Radius Metric (Polished Flutes)	149	
	43MCR	3 Flute Non-Ferrous Corner Radius 4xD Metric (Polished Flutes)	149	
	43ML	3 Flute Non-Ferrous Square End Long Reach Metric	152	
	43MLC	3 Flute Non-Ferrous Long Reach Corner Radius Metric (Unpolished Flutes)	152	
	43MLC	3 Flute Non-Ferrous Long Reach Corner Radius Metric (Polished Flutes)	152	
	43MB	3 Flute Non-Ferrous Ball End Metric (Polished Flutes)	154	
	S-Carb® Rougher (3 Flute)	43CB	3 Flute Rougher Non-Ferrous Chip Breaker Fractional	146
		43LCB	3 Flute Rougher Non-Ferrous Chip Breaker Long Reach Fractional	147
43MCB		3 Flute Rougher Non-Ferrous Chip Breaker Metric	155	
S-Carb® (2 Flute)	47	2 Flute Non-Ferrous Square End Fractional	157	
	47L	2 Flute Non-Ferrous Square End Long Reach Fractional	157	
	47B	2 Flute Non-Ferrous Ball End Fractional	158	
	47LB	2 Flute Non-Ferrous Ball End Long Reach Fractional	158	
	47M	2 Flute Non-Ferrous Square End Metric	160	
	47ML	2 Flute Non-Ferrous Square End Long Reach Metric	160	
	47MB	2 Flute Non-Ferrous Ball End Metric	161	
47MLB	2 Flute Non-Ferrous Ball End Long Reach Metric	161		
Ski-Carb	44	2 Flute Non-Ferrous Materials Square End Fractional	163	
	44M	2 Flute Non-Ferrous Materials Square End Metric	163	
	45	2 Flute Non-Ferrous Materials Long Reach Corner Radius Fractional	166	

Speed & Feed Recommendations listed after each series

Fresado

FRESAS DE ALTO RENDIMIENTO PARA ALUMINIO	SERIE	DESCRIPCIÓN	PÁGINA	
S-Carb APR® y APF®	43APR-3	3 filos, productividad avanzada, desbastador, fraccional	127	
	43APR-3	3 filos, productividad avanzada, desbastador, métrico	129	
	43APR-4	4 filos, productividad avanzada, desbastador, métrico	130	
	43APF	4 filos, productividad avanzada, acabador, fraccional	132	
	43MAPF	4 filos, productividad avanzada, acabador, métrico	134	
S-Carb® (3 filos)	43	3 filos, no férrico, punta cuadrada, fraccional	136	
	43CR	3 filos, no férrico, radio angulado, fraccional	136	
	43L	3 filos, no férrico, punta cuadrada, largo alcance, fraccional	140	
	43LC	3 filos, no férricos, largo alcance, radio angulado, fraccional	140	
	43EC	3 filos, no férrico, punta cuadrada, alcance extralargo, fraccional	143	
	43B	3 filos, no férrico, punta esférica, fraccional	144	
	43LB	3 filos, no férrico, punta esférica, largo alcance, fraccional	145	
	43EB	3 filos, no férrico, punta esférica, alcance extralargo, fraccional	145	
	43M	3 filos, no férrico, punta cuadrada, métrico (filos no pulidos)	149	
	43M	3 filos, no férrico, punta cuadrada, métrico (filos pulidos)	149	
	43MCR	3 filos, no férrico, radio angulado, métrico (filos no pulidos)	149	
	43MCR	3 filos, no férrico, radio angulado, métrico (filos pulidos)	149	
	43MCR	3 filos, no férrico, radio angulado 4xD, métrico (filos pulidos)	149	
	43ML	3 filos, no férrico, punta cuadrada, largo alcance, métrico	152	
	43MLC	3 filos, no férrico, largo alcance, radio angulado, métrico (filos no pulidos)	152	
	43MLC	3 filos, no férrico, largo alcance, radio angulado, métrico (filos pulidos)	152	
	43MB	3 filos, no férrico, punta esférica, métrico (filos pulidos)	154	
	Desbastador S-Carb® (3 filos)	43CB	3 filos, desbastador, no férrico, rompevirutas, fraccional	146
		43LCB	3 filos, desbastador, no férrico, rompevirutas, largo alcance, fraccional	147
43MCB		3 filos, desbastador, no férrico, rompevirutas, métrico	155	
S-Carb® (2 filos)	47	2 filos, no férrico, punta cuadrada, fraccional	157	
	47L	2 filos, no férrico, punta cuadrada, largo alcance, fraccional	157	
	47B	2 filos, no férrico, punta esférica, fraccional	158	
	47LB	2 filos, no férrico, punta esférica, largo alcance, fraccional	158	
	47M	2 filos, no férrico, punta cuadrada, métrico	160	
	47ML	2 filos, no férrico, punta cuadrada, largo alcance, métrico	160	
	47MB	2 filos, no férrico, punta esférica, métrico	161	
47MLB	2 filos, no férrico, punta esférica, largo alcance, métrico	161		
Ski-Carb	44	2 filos, materiales no férricos, punta cuadrada, fraccional	163	
	44M	2 filos, materiales no férricos, punta cuadrada, métrico	163	
	45	2 filos, materiales no férricos, largo alcance, radio angulado, fraccional	166	

Recomendaciones de velocidades y avances mostradas tras cada serie

FRAISE HAUTE PERFORMANCE POUR ALUMINIUM	SÉRIES	DESCRIPTION	PAGE	
S-Carb APR®/APF®	43APR-3	3 dents productivité avancée d'ébauche (fractionnel)	127	
	43APR-3	3 dents productivité avancée d'ébauche (métrique)	129	
	43APR-4	4 dents productivité avancée d'ébauche (métrique)	130	
	43APF	4 dents productivité avancée de finition (fractionnel)	132	
	43MAPF	4 dents productivité avancée de finition (métrique)	134	
	S-Carb® (3 dents)	43	3 dents non-ferreux non rayonné (fractionnel)	136
43CR		3 dents non-ferreux rayonné (fractionnel)	136	
43L		3 dents non-ferreux non rayonné longue portée (fractionnel)	140	
43LC		3 dents non-ferreux longue portée rayonné (fractionnel)	140	
43EC		3 dents non-ferreux non rayonné portée extra-longue (fractionnel)	143	
43B		3 dents non-ferreux à bout hémisphérique (fractionnel)	144	
43LB		3 dents non-ferreux à bout hémisphérique longue portée (fractionnel)	145	
43EB		3 dents non-ferreux à bout hémisphérique portée extra-longue (fractionnel)	145	
43M		3 dents non-ferreux non rayonné (métrique) (goujures non polies)	149	
43M		3 dents non-ferreux non rayonné (métrique) (goujures polies)	149	
43MCR		3 dents matériaux non-ferreux rayonné (métrique) (goujures non polies)	149	
43MCR		3 dents matériaux non-ferreux rayonné (métrique) (goujures polies)	149	
43MCR		3 dents matériaux non-ferreux rayonné 4xD (métrique) (goujures polies)	149	
43MLC		3 dents non-ferreux longue portée rayonné (métrique) (goujures non polies)	152	
43MLC		3 dents non-ferreux longue portée rayonné (métrique) (goujures polies)	152	
43ML		3 dents non-ferreux non rayonné longue portée (métrique)	152	
43MB		3 dents non-ferreux à bout hémisphérique (métrique) (goujures polies)	154	
S-Carb® d'ébauche (3 dents)		43CB	3 dents d'ébauche non-ferreux brise-copeaux (fractionnel)	146
		43LCB	3 dents d'ébauche non-ferreux brise-copeaux longue portée (fractionnel)	147
		43MCB	3 dents d'ébauche non-ferreux brise-copeaux (métrique)	155
S-Carb® (2 dents)	47	2 dents non-ferreux non rayonné (fractionnel)	157	
	47L	2 dents non-ferreux non rayonné longue portée (fractionnel)	157	
	47B	2 dents non-ferreux à bout hémisphérique (fractionnel)	158	
	47LB	2 dents non-ferreux à bout hémisphérique longue portée (fractionnel)	158	
	47M	2 dents non-ferreux non rayonné (métrique)	160	
	47ML	2 dents non-ferreux non rayonné longue portée (métrique)	160	
	47MB	2 dents non-ferreux à bout hémisphérique (métrique)	161	
	47MLB	2 dents non-ferreux à bout hémisphérique longue portée (métrique)	161	
Ski-Carb	44	2 dents matériaux non-ferreux non rayonné (fractionnel)	163	
	44M	2 dents matériaux non-ferreux non rayonné (métrique)	163	
	45	2 dents matériaux non-ferreux longue portée rayonné (fractionnel)	166	

Recommandations de vitesse et avance indiquées après chaque série

HOCHLEISTUNGSSCHAFTFRÄSER FÜR ALUMINIUM	SERIE	BESCHREIBUNG	SEITE	
S-Carb APR® & APF®	43APR-3	Hochleistungs-Schrupfräser mit 3 Schneiden	127	
	43APR-3	Hochleistungs-Schrupfräser mit 3 Schneiden (Erweiterung)	129	
	43APR-4	Hochleistungs-Schrupfräser mit 4 Schneiden	130	
	43APF	Zölliger Hochleistungs-Schlichtfräser mit 4 Schneiden	132	
	43MAPF	Hochleistungs-Schlichtfräser mit 4 Schneiden	134	
S-Carb® (3 Schneiden)	43	Zölliger NE-Schaftfräser mit 3 Schneiden ohne Eckenradien	136	
	43CR	Zölliger NE-Fräser mit 3 Schneiden und Eckenradien	136	
	43L	Zölliger NE-Langloch-Schaftfräser mit 3 Schneiden ohne Eckenradien	140	
	43LC	Zölliger Langlochfräser mit 3 Schneiden und Eckenradien	140	
	43EC	Zölliger NE-Superlangloch-Schaftfräser mit 3 Schneiden ohne Eckenradien	143	
	43B	Zölliger NE-Radiuschaftfräser mit 3 Schneiden	144	
	43LB	Zölliger NE-Langloch-Radiuschaftfräser mit 3 Schneiden	145	
	43EB	Zölliger NE-Superlangloch-Radiuschaftfräser mit 3 Schneiden	145	
	43M	NE-Schaftfräser mit 3 unpolierten Schneiden ohne Eckenradien	149	
	43M	NE-Schaftfräser mit 3 polierten Schneiden ohne Eckenradien	149	
	43MCR	NE-Fräser mit 3 unpolierten Schneiden und Eckenradien	149	
	43MCR	NE-Fräser mit 3 polierten Schneiden und Eckenradien	149	
	43MCR	NE-Fräser 4xD mit 3 polierten Schneiden und Eckenradien	149	
	43ML	NE-Langloch-Schaftfräser mit 3 Schneiden ohne Eckenradien	152	
	43MLC	NE-Langlochfräser mit 3 unpolierten Schneiden und Eckenradien	152	
	43MLC	NE-Langlochfräser mit 3 polierten Schneiden und Eckenradien	152	
	43MB	NE-Radiuschaftfräser mit 3 polierten Schneiden	154	
	S-Carb® Schrupfräser (3 Schneiden)	43CB	Zölliger NE-Schrupfräser mit 3 Schneiden und Spanbrechern	146
		43LCB	Zölliger NE-Langloch-Schrupfräser mit 3 Spanteilernuten	147
		43MCB	NE-Schrupfräser mit 3 Schneiden und Spanbrechern	155
S-Carb® (2 Schneiden)	47	Zölliger NE-Schaftfräser mit 2 Schneiden ohne Eckenradien	157	
	47L	Zölliger NE-Langloch-Schaftfräser mit 2 Schneiden ohne Eckenradien	157	
	47B	Zölliger NE-Radiuschaftfräser mit 2 Schneiden	158	
	47LB	Zölliger NE-Langloch-Radiuschaftfräser mit 2 Schneiden	158	
	47M	NE-Schaftfräser mit 2 Schneiden ohne Eckenradien	160	
	47ML	NE-Langloch-Schaftfräser mit 2 Schneiden ohne Eckenradien	160	
	47MB	NE-Radiuschaftfräser mit 2 Schneiden	161	
	47MLB	NE-Langloch-Radiuschaftfräser mit 2 Schneiden	161	
Ski-Carb	44	Zölliger NE-Schaftfräser mit 2 Schneiden ohne Eckenradien	163	
	44M	NE-Schaftfräser mit 2 Schneiden ohne Eckenradien	163	
	45	Zölliger Langlochfräser mit 2 Schneidenn und Eckenradien für Nichteisenmetalle	166	

Empfehlungen für Drehzahl & Vorschub im Anhang zu jeder Serie

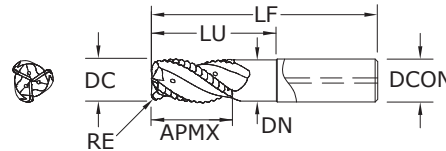
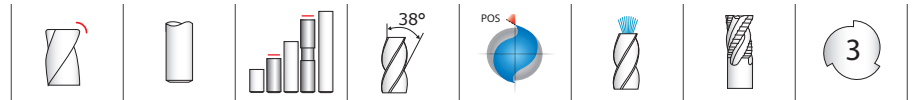

43APR-3
FRACTIONAL SERIES

TOLERANCES (inch)

1/2-1 DIAMETER

DC = -0.0004/-0.004

DCON = h₆

RE = +/-0.002

NON-FERROUS

For patent information visit www.ksptpatents.com

mm							EDP NO.
CUTTING DIAMETER DC	LENGTH OF CUT APMX	OVERALL LENGTH LF	SHANK DIAMETER DCON	REACH LU	NECK DIAMETER DN	CORNER RADIUS RE	Ti-NAMITE-B (TiB ₂)
1/2	1	3-1/4	1/2	1-1/2	.474	.030	34100
1/2	1	3-1/4	1/2	1-1/2	.474	.060	34101
1/2	1	3-1/4	1/2	1-1/2	.474	.090	34102
1/2	1	3-1/4	1/2	1-1/2	.474	.120	34103
5/8	1-3/8	3-5/8	5/8	2	.594	.030	34104*
5/8	1-3/8	3-5/8	5/8	2	.594	.060	34105*
5/8	1-3/8	3-5/8	5/8	2	.594	.090	34106*
5/8	1-3/8	3-5/8	5/8	2	.594	.120	34107*
5/8	1-3/8	4-1/4	5/8	2-5/8	.594	.030	34108*
5/8	1-3/8	4-1/4	5/8	2-5/8	.594	.060	34109*
5/8	1-3/8	4-1/4	5/8	2-5/8	.594	.090	34110*
5/8	1-3/8	4-1/4	5/8	2-5/8	.594	.120	34111*
3/4	1-3/8	3-5/8	3/4	1-3/4	.713	.030	34112
3/4	1-3/8	3-5/8	3/4	1-3/4	.713	.060	34113
3/4	1-3/8	3-5/8	3/4	1-3/4	.713	.090	34114
3/4	1-3/8	3-5/8	3/4	1-3/4	.713	.120	34115
3/4	1-3/8	4-3/8	3/4	2-1/2	.713	.030	34116*
3/4	1-3/8	4-3/8	3/4	2-1/2	.713	.060	34117*
3/4	1-3/8	4-3/8	3/4	2-1/2	.713	.090	34118*
3/4	1-3/8	4-3/8	3/4	2-1/2	.713	.120	34119*
3/4	1-3/8	5-1/4	3/4	3-1/4	.713	.030	34120*
3/4	1-3/8	5-1/4	3/4	3-1/4	.713	.060	34121*
3/4	1-3/8	5-1/4	3/4	3-1/4	.713	.090	34122*
3/4	1-3/8	5-1/4	3/4	3-1/4	.713	.120	34123*
1	1-3/4	4-1/2	1	2-1/2	.949	.030	34124
1	1-3/4	4-1/2	1	2-1/2	.949	.060	34125
1	1-3/4	4-1/2	1	2-1/2	.949	.090	34126
1	1-3/4	4-1/2	1	2-1/2	.949	.120	34127
1	1-3/4	5-1/4	1	3-1/4	.949	.030	34128*
1	1-3/4	5-1/4	1	3-1/4	.949	.060	34129*
1	1-3/4	5-1/4	1	3-1/4	.949	.090	34130*
1	1-3/4	5-1/4	1	3-1/4	.949	.120	34131*
1	1-3/4	6-1/4	1	4-1/4	.949	.030	34132*
1	1-3/4	6-1/4	1	4-1/4	.949	.060	34133*
1	1-3/4	6-1/4	1	4-1/4	.949	.090	34134*
1	1-3/4	6-1/4	1	4-1/4	.949	.120	34135*

- Ultra high-productivity rougher for Aluminum alloys, specifically for aircraft components
- Designed for machine tools with capability of 12 IP per minute material removal rates
- New 3 flute variable geometry with side exit coolant holes
- Open fluting for deep slotting and profiling
- Recommended for materials ≤ 150 Bhn (≤ 7 HRC)

*Variable Helix

FRACTIONAL S-Carb APR®

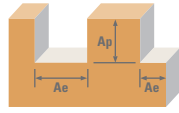

Series 43APR-3 Fractional	Ae x DC	Ap x DC	Vc (sfm)	DC • inch			
				APR-3			
				0.75	1		
N ALUMINIUM ALLOYS 6068, 7075	Slot 	1	≤ 1	5250	RPM	26740	20055
				(980-6900)	Fz	0.0055	0.0059
					Feed (ipm)	441	355
	Profile 	≤ 0.5	≤ 1.5	5900	RPM	30051	22538
				(980-6900)	Fz	0.0063	0.0067
					Feed (ipm)	568	453
	HSM 	≤ 0.1	≤ 2	6900	RPM	35144	26358
				(980-6900)	Fz	0.0075	0.0079
					Feed (ipm)	791	625

Series 43APR-3L Fractional	Ae x DC	Ap x DC	Vc (sfm)	DC • inch					
				APR-3 LONG					
				0.5	0.625	0.75	1		
N ALUMINIUM ALLOYS 6068, 7075	Slot 	1	≤ 1	3280	RPM	25059	20047	16706	12530
				(980-6900)	Fz	0.0039	0.0043	0.0047	0.0051
					Feed (ipm)	293	259	236	192
	Profile 	≤ 0.5	≤ 1.5	3950	RPM	30178	24142	20119	15089
				(980-6900)	Fz	0.0047	0.0051	0.0055	0.0059
					Feed (ipm)	426	369	332	267
	HSM 	≤ 0.1	≤ 2	4600	RPM	35144	28115	23429	17572
				(980-6900)	Fz	0.0055	0.0059	0.0063	0.0067
					Feed (ipm)	580	498	443	353

RPM stated may be outside of most machine tools in the smaller sizes, adjust the surface speed but maintain the Fz
 For best results use the peak power of the specific machine torque chart.
 Typically 10hp is required to remove 45 cubic inches of material (MRR).
 Eg. >> (Ae x Ap x Feed) >> Therefore Full slotting 1" dia: 1 x 1 x 355 = 355 cubic inches, so it needs a min of 78hp.
 Larger cuts and chip load consume more power.
 Review the power chart of each machine to determine MAX power for ultimate performance.
 Example below shows peak power @ 10,000 rpm.
 The new coolant supply is designed for MQL as well as normal emulsion coolant on the same data.
 Ensure max MQL flow prior to cutting.
 Refer to the SGS Tool Wizard® for complete technical information (www.kyocera-sgstool.com).

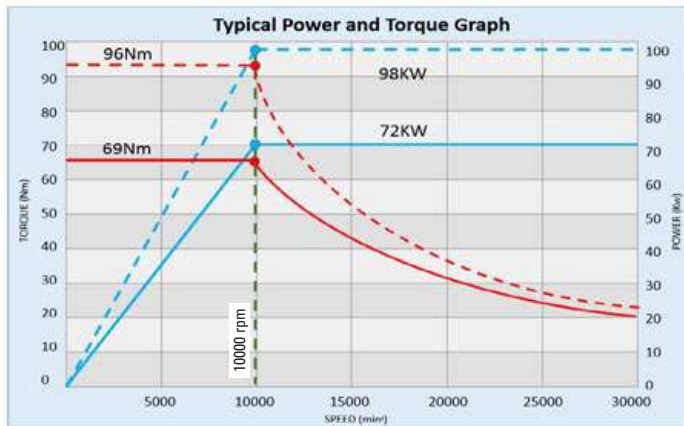

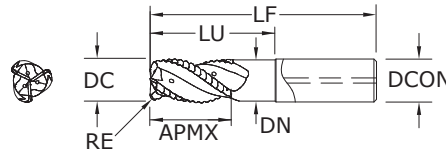

43APR-3
METRIC SERIES

TOLERANCES (mm)

12–25 DIAMETER

DC = -0,010/-0,100

DCON = h₆

RE = +/-0,05

NON-FERROUS

For patent information visit www.ksptpatents.com

mm							EDP NO.
CUTTING DIAMETER DC	LENGTH OF CUT APMX	OVERALL LENGTH LF	SHANK DIAMETER DCON	REACH LU	NECK DIAMETER DN	CORNER RADIUS RE	Ti-NAMITE-B (TiB ₂)
12,0	26,0	83,0	12,0	39,0	11,4	1,0	44976*
12,0	26,0	83,0	12,0	39,0	11,4	2,0	44977*
12,0	26,0	83,0	12,0	39,0	11,4	3,0	44978*
12,0	26,0	83,0	12,0	39,0	11,4	4,0	44979*
12,0	26,0	95,0	12,0	—	—	—	44975*
16,0	35,0	92,0	16,0	—	—	—	44980
16,0	35,0	92,0	16,0	51,0	15,2	2,0	44981*
16,0	35,0	92,0	16,0	51,0	15,2	3,0	44982*
16,0	35,0	92,0	16,0	51,0	15,2	4,0	44983*
16,0	35,0	108,0	16,0	67,0	15,2	2,0	44985*
16,0	35,0	108,0	16,0	67,0	15,2	3,0	44986*
16,0	35,0	108,0	16,0	67,0	15,2	4,0	44987*
16,0	35,0	124,0	16,0	—	—	—	44984
20,0	35,0	86,0	20,0	—	—	—	44990
20,0	35,0	86,0	20,0	45,0	19,4	3,0	44991
20,0	35,0	86,0	20,0	45,0	19,4	4,0	44992
20,0	35,0	106,0	20,0	—	—	—	44993
20,0	35,0	106,0	20,0	65,0	19,4	2,0	44994*
20,0	35,0	106,0	20,0	65,0	19,4	3,0	44995*
20,0	35,0	106,0	20,0	65,0	19,4	4,0	44996*
20,0	35,0	106,0	20,0	65,0	19,4	5,0	44997*
20,0	35,0	125,0	20,0	84,0	19,0	2,0	45021*
20,0	35,0	125,0	20,0	84,0	19,0	3,0	45022*
20,0	35,0	125,0	20,0	84,0	19,0	4,0	45023*
20,0	35,0	145,0	20,0	—	—	—	45020
25,0	43,0	108,0	25,0	—	—	—	44998
25,0	43,0	108,0	25,0	60,0	24,4	2,0	44999
25,0	43,0	108,0	25,0	60,0	24,4	3,0	45000
25,0	43,0	108,0	25,0	60,0	24,4	4,0	45001
25,0	35,0	140,0	25,0	—	—	—	45002
25,0	35,0	140,0	25,0	80,0	24,4	3,0	45003*
25,0	35,0	140,0	25,0	90,0	24,4	3,0	45004*
25,0	35,0	151,0	25,0	—	—	—	45024
25,0	35,0	151,0	25,0	105,0	23,7	3,0	45025*

- Ultra high-productivity rougher for Aluminum alloys, specifically for aircraft components
- Designed for machine tools with capability of 12 IP per minute material removal rates
- New 3 flute variable geometry with side exit coolant holes
- Open fluting for deep slotting and profiling
- Recommended for materials ≤ 150 Bhn (≤ 7 HRC)

*Variable Helix

METRIC

S-Carb APR[®]

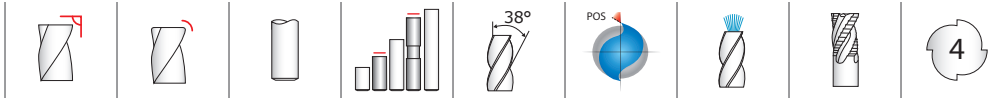

43APR-4 METRIC SERIES

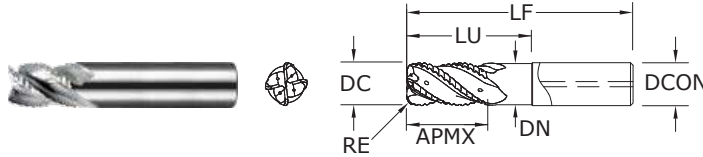

- Ultra high-productivity rougher for Aluminum alloys, specifically for aircraft components
- Designed for machine tools with capability of 12 l³ per minute material removal rates
- 4 flute variable geometry with side exit coolant holes
- Open fluting for deep slotting and profiling
- Recommended for materials ≤ 150 Bhn (≤ 7 HRC)

CUTTING DIAMETER DC	LENGTH OF CUT APMX	OVERALL LENGTH LF	mm				CORNER RADIUS RE	EDP NO.
			SHANK DIAMETER DCON	REACH LU	NECK DIAMETER DN	Ti-NAMITE-B (TiB ₂)		
20,0	35,0	86,0	20,0	—	18,97	—	45005	
20,0	35,0	86,0	20,0	45,0	19,00	3,0	45006	
20,0	35,0	86,0	20,0	45,0	19,00	4,0	45007	
20,0	35,0	106,0	20,0	—	19,00	—	45008	
20,0	35,0	106,0	20,0	65,0	19,00	2,0	45009	
20,0	35,0	106,0	20,0	65,0	19,00	3,0	45010	
20,0	35,0	106,0	20,0	65,0	19,00	4,0	45011	
20,0	35,0	106,0	20,0	65,0	19,00	5,0	45012	
25,0	43,0	108,0	25,0	—	23,75	—	45013	
25,0	43,0	108,0	25,0	60,0	23,75	2,0	45014	
25,0	43,0	108,0	25,0	60,0	23,75	3,0	45015	
25,0	43,0	108,0	25,0	60,0	23,75	4,0	45016	
25,0	35,0	140,0	25,0	—	23,75	—	45017	
25,0	35,0	140,0	25,0	80,0	23,75	3,0	45018	
25,0	35,0	140,0	25,0	90,0	23,75	3,0	45019	

TOLERANCES (mm)

20–25 DIAMETER
 DC = -0,010/-0,100
 DCON = h₆
 RE = ±0,050

NON-FERROUS

For patent information visit www.ksptpatents.com

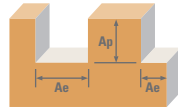

Series 43APR-3 43APR-4 Metric	Ae x DC	Ap x DC	Vc (m/min)	DC • mm					
				APR-3		APR-4			
				20	25	20	25		
N ALUMINIUM ALLOYS 6068, 7075	Slot 	1	≤ 1	1600	RPM	25461	20369	25461	20369
				(300-2100)	Fz	0.14	0.15	0.12	0.13
				Feed (mm/min)	10694	9166	12222	10592	
	Profile 	≤ 0.5	≤ 1.5	1800	RPM	28644	22915	28644	22915
				(300-2100)	Fz	0.16	0.17	0.14	0.15
				Feed (mm/min)	13749	11687	16041	13749	
	HSM 	≤ 0.1	≤ 2	2100	RPM	33418	26735	33418	26735
				(300-2100)	Fz	0.19	0.20	0.16	0.17
				Feed (mm/min)	19048	16041	21388	18180	

Series 43APR-3 43APR-4 Metric	Ae x DC	Ap x DC	Vc (m/min)	DC • mm					
				APR-3 LONG					
				12	16	20	25		
N ALUMINIUM ALLOYS 6068, 7075	Slot 	1	≤ 1	1600	RPM	26522	19892	15913	12731
				(300-2100)	Fz	0.10	0.11	0.12	0.13
				Feed (mm/min)	7957	6564	5729	4965	
	Profile 	≤ 0.5	≤ 1.5	1800	RPM	31827	23870	19096	15277
				(300-2100)	Fz	0.12	0.13	0.14	0.15
				Feed (mm/min)	11458	9309	8020	6875	
	HSM 	≤ 0.1	≤ 2	2100	RPM	37131	27849	22279	17823
				(300-2100)	Fz	0.14	0.15	0.16	0.17
				Feed (mm/min)	15595	12532	10694	9090	

RPM stated may be outside of most machine tools in the smaller sizes, adjust the surface speed but maintain the Fz
For best results use the peak power of the specific machine torque chart.

Typically 10kw is required to remove 1 litre of material (MMR).

Eg. >> (Ae x Ap x Feed) / 1000000 >> Therefore Full slotting Ø25: 25 x 25 x 7333 = 4.58 Litres so it needs a min of 46Kw.

Larger cuts and chip load consume more power.

Review the power chart of each machine to determine MAX power for ultimate performance.

Example below shows peak power @ 10,000 rpm.

The APR-4 design is for ultimate metal removal but typically requires more power, and is also better suited to horizontal machines.

The new coolant supply is designed for MQL as well as normal emulsion coolant on the same data.

Ensure max MQL flow prior to cutting.

Refer to the SGS Tool Wizard® for complete technical information (www.kyocera-sgstool.com).

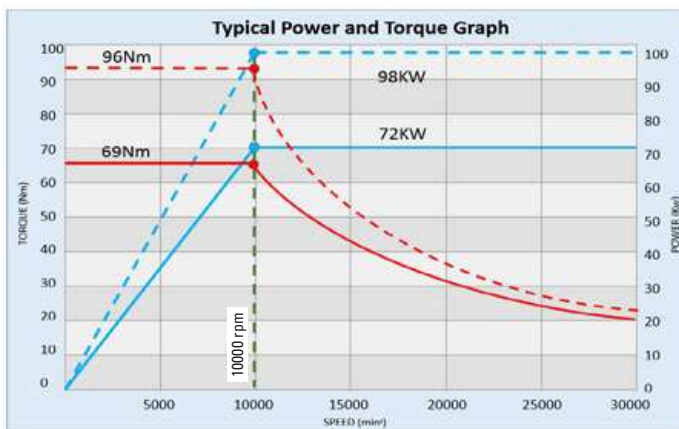

FRACTIONAL S-Carb APF®

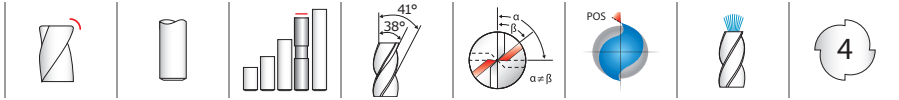

43APF FRACTIONAL SERIES

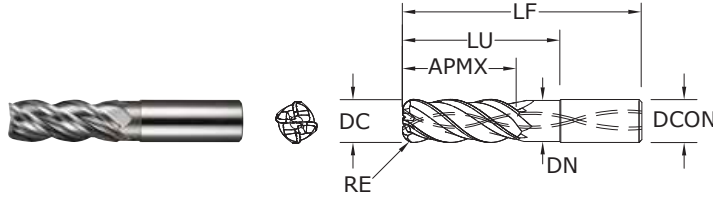

- Ultra high-productivity finisher for Aluminum alloys, specifically for aircraft components
- Two levels of chatter suppression: variable helix and indexing
- Designed for single axial pass semi-finishing and finishing
- Polished flutes maximize chip evacuation and provides enhanced finish
- Recommended for materials ≤ 150 Bhn (≤ 7 HRC)

CUTTING DIAMETER DC	LENGTH OF CUT APMX	OVERALL LENGTH LF	inch				CORNER RADIUS RE	EDP NO. Ti-NAMITE-B (TiB ₂)
			SHANK DIAMETER DCON	REACH LU	NECK DIAMETER DN			
1/2	1-1/4	3-1/4	1/2	1-5/8	.478	.030	34016	
1/2	1-1/4	3-1/4	1/2	1-5/8	.478	.060	34017	
1/2	1-1/4	3-1/4	1/2	1-5/8	.478	.090	34018	
1/2	1-1/4	3-1/4	1/2	1-5/8	.478	.120	34019	
1/2	2	4	1/2	2-3/8	.478	.030	34020	
1/2	2	4	1/2	2-3/8	.478	.060	34021	
1/2	2	4	1/2	2-3/8	.478	.090	34022	
1/2	2	4	1/2	2-3/8	.478	.120	34023	
3/4	1-7/8	4-1/4	3/4	2-3/8	.728	.030	34024	
3/4	1-7/8	4-1/4	3/4	2-3/8	.728	.060	34025	
3/4	1-7/8	4-1/4	3/4	2-3/8	.728	.090	34026	
3/4	1-7/8	4-1/4	3/4	2-3/8	.728	.120	34027	
3/4	3	5-3/8	3/4	3-1/2	.728	.030	34028	
3/4	3	5-3/8	3/4	3-1/2	.728	.060	34029	
3/4	3	5-3/8	3/4	3-1/2	.728	.090	34030	
3/4	3	5-3/8	3/4	3-1/2	.728	.120	34031	

Available on request: • JetStream Technology

TOLERANCES (inch)

1/2–3/4 DIAMETER

DC = $-0.0004/-0.0020$

DCON = h_6

RE = $+0.0000/-0.0012$

NON-FERROUS

For patent information visit www.ksptpatents.com

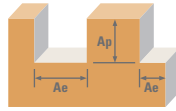

Series 43APF Fractional	Hardness	Profile	Ae x DC	Ap x DC	Vc (sfm)	DC • in		
						1/2	3/4	
ALUMINUM ALLOYS 2024, 5052, 5086, 6061, 6063, 7075	≤ 150 Bhn or ≤ 7 HRc	Profile 	≤ 0.1	≤ 2.5	2625 (2100-3150)	RPM	20055	13370
						Fz	0.0030	0.0050
						Feed (in/min)	241	267
	Profile 	≤ 0.1	≤ 4	2625 (2100-3150)	RPM	20055	13370	
					Fz	0.0020	0.0040	
					Feed (in/min)	160	214	
ALUMINUM ALLOYS (LITHIUM)* 2090, 2091, 2099, 2195, 2199, 2297, 8090	≤ 150 Bhn or ≤ 7 HRc	Profile 	≤ 0.1	≤ 2.5	1970 (1576-2364)	RPM	15051	10034
						Fz	0.0030	0.0050
						Feed (in/min)	181	201
	Profile 	≤ 0.1	≤ 4	1970 (1576-2364)	RPM	15051	10034	
					Fz	0.0020	0.0040	
					Feed (in/min)	120	161	

Bhn (Brinell) HRc (Rockwell C)
 surface speed is dependent on machine spindle and fixturing
 balancing is recommended at ultra high surface speeds
 tool life may be reduced when machining Lithium Alloys
 $rpm = Vc \times 3.82 / DC$
 $ipm = Fz \times 4 \times rpm$
 maximum recommended depths shown
 reduce speed and feed for materials harder than listed
 finish cuts typically require reduced feed and cutting depths of 0.02 X DC maximum
 ramp angle = 6° (feed rate = 50%)
 plunging not recommended
 refer to the SGS Tool Wizard® for complete technical information (www.kyocera-sgstool.com)

S-Carb APF®

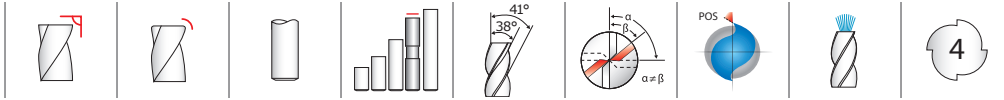

43MAPF METRIC SERIES

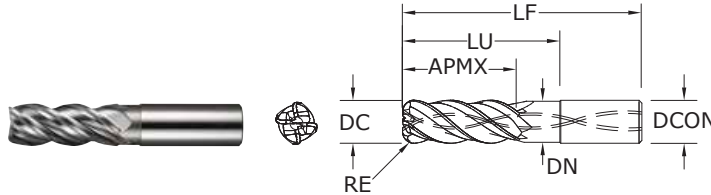

- Ultra high-productivity finisher for Aluminum alloys, specifically for aircraft components
- Two levels of chatter suppression: variable helix and indexing
- Designed for single axial pass semi-finishing and finishing
- Polished flutes maximize chip evacuation and provides enhanced finish
- Recommended for materials ≤ 150 Bhn (≤ 7 HRC)

CUTTING DIAMETER DC	LENGTH OF CUT APMX	OVERALL LENGTH LF	mm				CORNER RADIUS RE	EDP NO.
			SHANK DIAMETER DCON	REACH LU	NECK DIAMETER DN	Ti-NAMITE-B (TiB ₂)		
6,0	24,0	58,0	6,0	30,0	5,66	—	44627	
8,0	32,0	64,0	8,0	40,0	7,57	—	44628	
10,0	40,0	80,0	10,0	50,0	9,47	—	44629	
12,0	30,0	83,0	12,0	40,0	11,38	—	44630	
12,0	30,0	83,0	12,0	40,0	11,38	2,0	44745	
12,0	30,0	83,0	12,0	40,0	11,38	3,0	44746	
12,0	30,0	83,0	12,0	40,0	11,38	4,0	44747	
12,0	30,0	83,0	12,0	50,0	11,38	0,5	44641	
12,0	30,0	83,0	12,0	50,0	11,38	5,0	44642	
12,0	48,0	100,0	12,0	62,0	11,38	—	44631	
12,0	48,0	100,0	12,0	62,0	11,38	2,0	44748	
12,0	48,0	100,0	12,0	62,0	11,38	3,0	44749	
12,0	48,0	100,0	12,0	62,0	11,38	4,0	44750	
16,0	40,0	92,0	16,0	51,0	15,16	—	44634	
16,0	40,0	92,0	16,0	51,0	15,16	2,0	44751	
16,0	40,0	92,0	16,0	51,0	15,16	3,0	44752	
16,0	40,0	92,0	16,0	51,0	15,16	4,0	44753	
16,0	42,0	93,0	16,0	51,0	15,16	5,0	44643	
16,0	64,0	125,0	16,0	82,0	15,16	—	44635	
16,0	64,0	125,0	16,0	82,0	15,16	2,0	44754	
16,0	64,0	125,0	16,0	82,0	15,16	3,0	44755	
16,0	64,0	125,0	16,0	82,0	15,16	4,0	44756	
20,0	50,0	108,0	20,0	63,0	18,97	—	44636	
20,0	50,0	108,0	20,0	63,0	18,97	3,0	44757	
20,0	50,0	108,0	20,0	63,0	18,97	4,0	44758	
20,0	50,0	108,0	20,0	63,0	18,97	5,0	44759	
20,0	80,0	150,0	20,0	102,0	18,97	—	44637	
20,0	80,0	150,0	20,0	102,0	18,97	3,0	44760	
20,0	80,0	150,0	20,0	102,0	18,97	4,0	44761	
20,0	80,0	150,0	20,0	102,0	18,97	5,0	44762	
25,0	63,0	130,0	25,0	79,0	23,75	—	44638	
25,0	63,0	130,0	25,0	79,0	23,75	3,0	44763	
25,0	63,0	130,0	25,0	79,0	23,75	4,0	44764	
25,0	63,0	130,0	25,0	79,0	23,75	5,0	44765	
25,0	100,0	175,0	25,0	120,0	23,75	—	44639	
25,0	100,0	175,0	25,0	120,0	23,75	3,0	44766	
25,0	100,0	175,0	25,0	120,0	23,75	4,0	44767	
25,0	100,0	175,0	25,0	120,0	23,75	5,0	44768	

Available on request: • JetStream Technology

TOLERANCES (mm)

6-25 DIAMETER

DC = $-0,010/-0,050$

DCON = h_6

RE = $+0,000/-0,030$

NON-FERROUS

For patent information visit www.ksptpatents.com

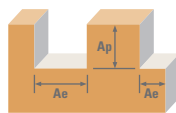

Series 43MAPF Metric	Hardness	Profile	Ae x DC	Ap x DC	Vc (m/min)	DC • mm							
						6	8	10	12	16	20	25	
N	ALUMINUM ALLOYS 2024, 5052, 5086, 6061, 6063, 7075	Profile 	≤ 0.1	≤ 2.5	800	RPM	42440	31830	25464	21220	15915	12732	10186
					(640-960)	Fz	0.050	0.055	0.060	0.070	0.100	0.140	0.170
					Feed (mm/min)	8488	7003	6111	5942	6366	7130	6926	
	ALUMINUM ALLOYS (LITHIUM)* 2090, 2091, 2099, 2195, 2199, 2297, 8090	Profile 	≤ 0.1	≤ 4	800	RPM	42440	31830	25464	21220	15915	12732	10186
					(640-960)	Fz	0.040	0.045	0.050	0.050	0.070	0.100	0.120
					Feed (mm/min)	6790	5729	5093	4244	4456	5093	4889	
ALUMINUM ALLOYS (LITHIUM)* 2090, 2091, 2099, 2195, 2199, 2297, 8090	Profile 	≤ 0.1	≤ 2.5	600	RPM	31830	23873	19098	15915	11936	9549	7639	
				(480-720)	Fz	0.050	0.055	0.060	0.070	0.100	0.140	0.170	
				Feed (mm/min)	6366	5252	4584	4456	4774	5347	5195		
ALUMINUM ALLOYS (LITHIUM)* 2090, 2091, 2099, 2195, 2199, 2297, 8090	Profile 	≤ 0.1	≤ 4	600	RPM	31830	23873	19098	15915	11936	9549	7639	
				(480-720)	Fz	0.040	0.045	0.050	0.050	0.070	0.100	0.120	
				Feed (mm/min)	5093	4297	3820	3183	3342	3820	3667		

Bhn (Brinell) HRC (Rockwell C)
 surface speed is dependent on machine spindle and fixturing
 balancing is recommended at ultra high surface speeds
 *tool life may be reduced when machining Lithium Alloys
 $rpm = (Vc \times 1000) / (DC \times 3.14)$
 $mm/min = Fz \times 4 \times rpm$
 maximum recommended depths shown
 reduce speed and feed for materials harder than listed
 finish cuts typically require reduced feed and cutting depths of 0.02 X DC maximum
 ramp angle = 6° (feed rate = 50%)
 plunging not recommended
 refer to the SGS Tool Wizard® for complete technical information (www.kyocera-sgstool.com)

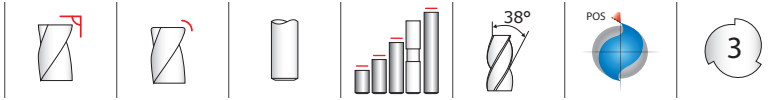

**43 •
43CR**
FRACTIONAL SERIES

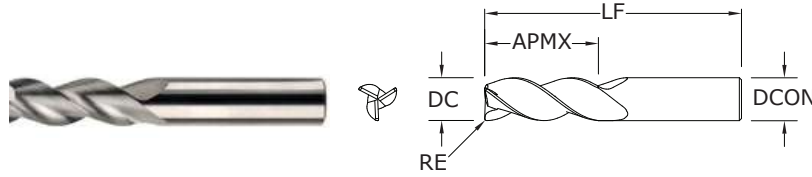

- Circular land allows for increased control at various speed and feed rates and reduces chatter
- Symmetrical end gashing for excellent balance at high speeds and aggressive plunging capability
- Open fluting for deep slotting and profiling
- Enhanced corner geometry with tight tolerance corner radii
- Recommended for materials ≤ 150 Bhn (≤ 7 HRC)

CUTTING DIAMETER DC	LENGTH OF CUT APMX	inch			EDP NO.	
		OVERALL LENGTH LF	SHANK DIAMETER DCON	CORNER RADIUS RE	UNCOATED	Ti-NAMITE-B (TiB ₂)
1/8	3/8	1-1/2	1/8	–	34701	34728
1/8	3/8	1-1/2	1/8	.010	34771	34793
3/16	5/16	2-1/2	3/16	–	34822	34857
3/16	9/16	2	3/16	–	34702	34729
3/16	9/16	2	3/16	.010	34772	34794
3/16	3/4	2-1/2	3/16	–	34823	34858
1/4	3/8	2	1/4	–	34703	34730
1/4	3/8	2-1/2	1/4	.010	35575	35665
1/4	3/8	2-1/2	1/4	.015	35576	35666
1/4	3/8	2-1/2	1/4	.030	35577	35667
1/4	3/8	2-1/2	1/4	.060	35578	35668
1/4	1/2	2-1/2	1/4	–	34824	34859
1/4	3/4	2-1/2	1/4	–	34704	34731
1/4	3/4	2-1/2	1/4	.010	34773	34795
1/4	3/4	2-1/2	1/4	.015	35579	35669
1/4	3/4	2-1/2	1/4	.030	34774	34796
1/4	3/4	2-1/2	1/4	.060	35580	35670
1/4	1	3	1/4	–	34825	34860
1/4	1	3	1/4	.010	35581	35671
1/4	1	3	1/4	.015	35582	35672
1/4	1	3	1/4	.030	35583	35673
1/4	1	3	1/4	.060	35584	35674
1/4	1-1/4	3-1/2	1/4	–	34705	34732
1/4	1-3/4	4	1/4	–	34826	34861
5/16	7/16	2	5/16	–	34706	34733
5/16	5/8	2-1/2	5/16	–	34707	34734
5/16	5/8	2-1/2	5/16	.030	34775	34797
5/16	1-1/4	4	5/16	–	34708	34735
3/8	1/2	2	3/8	–	34709	34736
3/8	1/2	3	3/8	.010	35585	35675
3/8	1/2	3	3/8	.015	35586	35676
3/8	1/2	3	3/8	.030	35587	35677
3/8	1/2	3	3/8	.060	35588	35678
3/8	1/2	3	3/8	.090	35589	35679
3/8	1	2-1/2	3/8	–	34710	34737
3/8	1	2-1/2	3/8	.010	34776	34798

TOLERANCES (inch)

- 1/8–3/16 DIAMETER**
DC = +0.0000/–0.00032
DCON = h₆
RE = +0.0000/–0.0020
- 1/4–3/8 DIAMETER**
DC = +0.0000/–0.00035
DCON = h₆
RE = +0.0000/–0.0020
- 1/2–5/8 DIAMETER**
DC = +0.0000/–0.00043
DCON = h₆
RE = +0.0000/–0.0020
- 3/4–1 DIAMETER**
DC = +0.0000/–0.00051
DCON = h₆
RE = +0.0000/–0.0020

NON-FERROUS
PLASTICS/COMPOSITES

For patent information visit www.kspatents.com

continued on next page

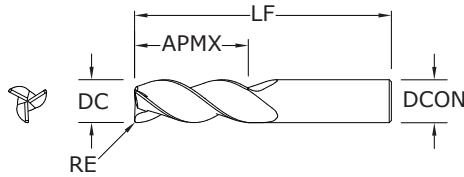
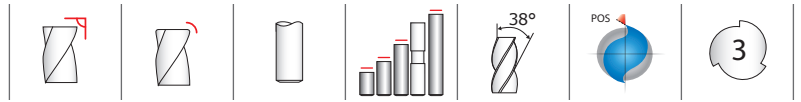

43 •
43CR
FRACTIONAL SERIES

CONTINUED

TOLERANCES (inch)

1/8–3/16 DIAMETER

DC = +0.0000/–0.00032

DCON = h₆

RE = +0.0000/–0.0020

1/4–3/8 DIAMETER

DC = +0.0000/–0.00035

DCON = h₆

RE = +0.0000/–0.0020

1/2–5/8 DIAMETER

DC = +0.0000/–0.00043

DCON = h₆

RE = +0.0000/–0.0020

3/4–1 DIAMETER

DC = +0.0000/–0.00051

DCON = h₆

RE = +0.0000/–0.0020

NON-FERROUS

PLASTICS/COMPOSITES

For patent
information visit
www.ksptpatents.com

CUTTING DIAMETER DC	LENGTH OF CUT APMX	inch			EDP NO.	
		OVERALL LENGTH LF	SHANK DIAMETER DCON	CORNER RADIUS RE	UNCOATED	Ti-NAMITE-B (TiB ₂)
3/8	1	2-1/2	3/8	.030	34777	34799
3/8	1	2-1/2	3/8	.060	32761	32825
3/8	1	3	3/8	.015	35590	35680
3/8	1	3	3/8	.090	35591	35681
3/8	1-1/4	3-1/2	3/8	–	34827	34862
3/8	1-1/2	3-1/2	3/8	–	34711	34738
3/8	1-1/2	4	3/8	.010	35592	35682
3/8	1-1/2	4	3/8	.015	35593	35683
3/8	1-1/2	4	3/8	.030	35594	35684
3/8	1-1/2	4	3/8	.060	35595	35685
3/8	1-1/2	4	3/8	.090	35596	35686
3/8	2	4	3/8	–	34828	34863
1/2	5/8	2-1/2	1/2	–	34712	34739
1/2	5/8	3	1/2	.010	35597	35687
1/2	5/8	3	1/2	.015	35598	35688
1/2	5/8	3	1/2	.030	35599	35689
1/2	5/8	3	1/2	.060	35600	35690
1/2	5/8	3	1/2	.090	35601	35691
1/2	5/8	3	1/2	.120	35602	35692
1/2	1	3	1/2	–	34830	34865
1/2	1	3	1/2	.010	35603	35693
1/2	1	3	1/2	.015	35604	35694
1/2	1	3	1/2	.030	35605	35695
1/2	1	3	1/2	.060	35606	35696
1/2	1	3	1/2	.090	35607	35697
1/2	1	3	1/2	.120	35608	35698
1/2	1-1/4	3	1/2	.015	35609	35699
1/2	1-1/4	3-1/4	1/2	–	34713	34740
1/2	1-1/4	3-1/4	1/2	.010	34778	34800
1/2	1-1/4	3-1/4	1/2	.030	34779	34801
1/2	1-1/4	3-1/4	1/2	.060	34780	34802
1/2	1-1/4	3-1/4	1/2	.090	34781	34803
1/2	1-1/4	3-1/4	1/2	.120	32766	32830
1/2	1-5/8	4	1/2	–	34831	34866
1/2	1-5/8	4	1/2	.010	35610	35700
1/2	1-5/8	4	1/2	.015	35611	35701

continued on next page

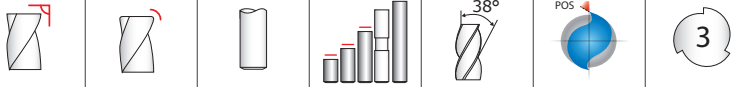

**43 •
43CR**
FRACTIONAL SERIES

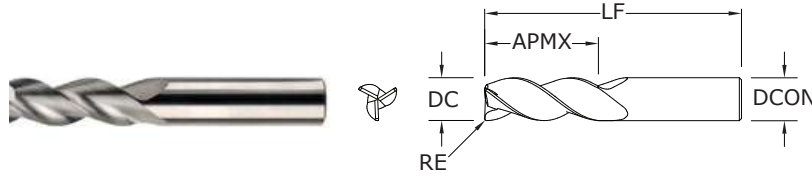

CONTINUED

CUTTING DIAMETER DC	LENGTH OF CUT APMX	inch			EDP NO.	
		OVERALL LENGTH LF	SHANK DIAMETER DCON	CORNER RADIUS RE	UNCOATED	Ti-NAMITE-B (TiB ₂)
1/2	1-5/8	4	1/2	.030	35612	35702
1/2	1-5/8	4	1/2	.060	35613	35703
1/2	1-5/8	4	1/2	.090	35614	35704
1/2	1-5/8	4	1/2	.120	35615	35705
1/2	2	4	1/2	.010	35616	35706
1/2	2	4	1/2	.015	35617	35707
1/2	2	4	1/2	.030	35618	35708
1/2	2	4	1/2	.060	35619	35709
1/2	2	4	1/2	.090	35620	35710
1/2	2	4	1/2	.120	35621	35711
1/2	2	4	1/2	—	34714	34741
1/2	2-1/2	5	1/2	—	34832	34867
1/2	3-1/8	6	1/2	—	34715	34742
5/8	3/4	3	5/8	—	34716	34743
5/8	3/4	3-1/2	5/8	.030	35622	35712
5/8	3/4	3-1/2	5/8	.060	35623	35713
5/8	3/4	3-1/2	5/8	.090	35624	35714
5/8	3/4	3-1/2	5/8	.120	35625	35715
5/8	1-5/8	3-3/4	5/8	—	34717	34744
5/8	1-5/8	3-3/4	5/8	.030	34782	34804
5/8	1-5/8	3-3/4	5/8	.060	34783	34805
5/8	1-5/8	3-3/4	5/8	.090	34784	34806
5/8	1-5/8	3-3/4	5/8	.120	35626	35716
5/8	2-1/8	4	5/8	—	34833	34868
5/8	2-1/2	5	5/8	—	34718	34745
5/8	3-1/4	6	5/8	—	34834	34869
5/8	3-3/4	6	5/8	—	34719	34746
3/4	1	3	3/4	—	34720	34747
3/4	1	4	3/4	.030	35627	35717
3/4	1	4	3/4	.060	35628	35718
3/4	1	4	3/4	.090	35629	35719
3/4	1	4	3/4	.120	35630	35720
3/4	1	4	3/4	.190	35631	35721
3/4	1	4	3/4	.250	35632	35722
3/4	1-5/8	4	3/4	—	34721	34748
3/4	1-5/8	4	3/4	.030	34785	34807

TOLERANCES (inch)

- 1/8–3/16 DIAMETER**
DC = +0.0000/–0.00032
DCON = h₆
RE = +0.0000/–0.0020
- 1/4–3/8 DIAMETER**
DC = +0.0000/–0.00035
DCON = h₆
RE = +0.0000/–0.0020
- 1/2–5/8 DIAMETER**
DC = +0.0000/–0.00043
DCON = h₆
RE = +0.0000/–0.0020
- 3/4–1 DIAMETER**
DC = +0.0000/–0.00051
DCON = h₆
RE = +0.0000/–0.0020

- NON-FERROUS
- PLASTICS/COMPOSITES

For patent information visit www.kspatents.com

continued on next page

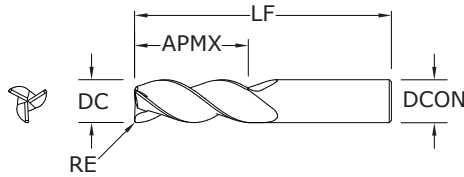
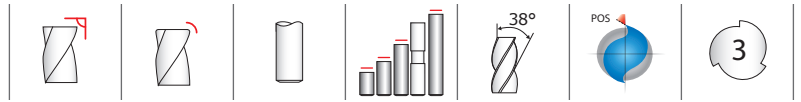

43 •
43CR
FRACTIONAL SERIES

CONTINUED

TOLERANCES (inch)

1/8–3/16 DIAMETER

DC = +0.0000/–0.00032

DCON = h₆

RE = +0.0000/–0.0020

1/4–3/8 DIAMETER

DC = +0.0000/–0.00035

DCON = h₆

RE = +0.0000/–0.0020

1/2–5/8 DIAMETER

DC = +0.0000/–0.00043

DCON = h₆

RE = +0.0000/–0.0020

3/4–1 DIAMETER

DC = +0.0000/–0.00051

DCON = h₆

RE = +0.0000/–0.0020

NON-FERROUS

PLASTICS/COMPOSITES

For patent information visit www.ksptpatents.com

CUTTING DIAMETER DC	LENGTH OF CUT APMX	inch			EDP NO.	
		OVERALL LENGTH LF	SHANK DIAMETER DCON	CORNER RADIUS RE	UNCOATED	Ti-NAMITE-B (TiB ₂)
3/4	1-5/8	4	3/4	.060	34786	34808
3/4	1-5/8	4	3/4	.090	34787	34809
3/4	1-5/8	4	3/4	.120	34815	34817
3/4	1-5/8	4	3/4	.190	35633	35723
3/4	1-5/8	4	3/4	.250	35634	35724
3/4	2-1/4	5	3/4	–	34722	34749
3/4	2-1/4	5	3/4	.030	35635	35725
3/4	2-1/4	5	3/4	.060	35636	35726
3/4	2-1/4	5	3/4	.090	35637	35727
3/4	2-1/4	5	3/4	.120	35638	35728
3/4	2-1/4	5	3/4	.190	35639	35729
3/4	2-1/4	5	3/4	.250	35640	35730
3/4	2-1/2	5	3/4	–	34758	34765
3/4	3-1/4	6	3/4	–	34723	34750
1	1-1/4	4	1	–	34724	34751
1	1-1/4	5	1	.030	35641	35731
1	1-1/4	5	1	.060	35642	35732
1	1-1/4	5	1	.090	35643	35733
1	1-1/4	5	1	.120	35644	35734
1	1-1/4	5	1	.190	35645	35735
1	1-1/4	5	1	.250	35646	35736
1	2	4-1/2	1	–	34725	34752
1	2	4-1/2	1	.030	34789	34811
1	2	4-1/2	1	.060	34790	34812
1	2	4-1/2	1	.090	34791	34813
1	2	4-1/2	1	.120	34816	34818
1	2	5	1	.190	35647	35737
1	2	5	1	.250	35648	35738
1	2-5/8	6	1	–	34726	34753
1	3-1/4	6	1	–	34727	34754
1	3-1/4	6	1	.030	35649	35739
1	3-1/4	6	1	.060	35650	35740
1	3-1/4	6	1	.090	35651	35741
1	3-1/4	6	1	.120	35652	35742
1	3-1/4	6	1	.190	35653	35743
1	3-1/4	6	1	.250	35654	35744
1	4-1/8	7	1	–	34835	34870

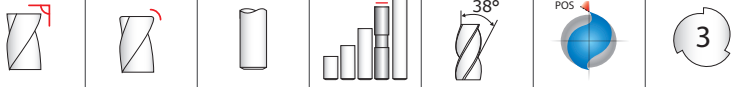

**43L •
43LC**

FRACTIONAL SERIES

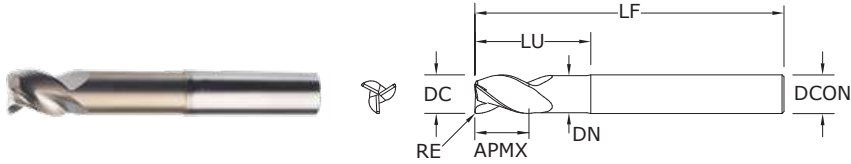

- Circular land allows for increased control at various speed and feed rates and reduces chatter
- Symmetrical end gashing for excellent balance at high speeds and aggressive plunging capability
- Open fluting for deep slotting and profiling
- Necked design with blended diameter transitions provide clearance to reach
- Enhanced corner geometry with tight tolerance corner radii
- Recommended for materials ≤ 150 Bhn (≤ 7 HRC)

CUTTING DIAMETER DC	LENGTH OF CUT APMX	OVERALL LENGTH LF	inch				EDP NO.	
			SHANK DIAMETER DCON	REACH LU	NECK DIAMETER DN	CORNER RADIUS RE	UNCOATED	Ti-NAMITE-B (TiB ₂)
1/8	5/32	3	1/8	1/2	.105	—	32700	32725
1/8	5/32	3	1/8	1/2	.105	.010	32751	32815
1/8	5/32	3	1/8	3/4	.105	—	32691	34888
3/16	7/32	3	3/16	1/2	.105	—	32701	32726
3/16	7/32	3	3/16	1/2	.167	.010	32752	32816
3/16	7/32	3	3/16	3/4	.167	—	32692	34889
1/4	3/8	2-1/2	1/4	3/4	.230	.015	35787	36235
1/4	3/8	2-1/2	1/4	3/4	.230	.060	35788	36236
1/4	3/8	4	1/4	3/4	.230	—	32702	32727
1/4	3/8	4	1/4	3/4	.230	.010	32753	32817
1/4	3/8	4	1/4	3/4	.230	.030	32754	32818
1/4	3/8	4	1/4	1-1/2	.230	—	32703	32728
1/4	3/8	4	1/4	1-1/2	.230	.010	32755	32819
1/4	3/8	4	1/4	1-1/2	.230	.030	32756	32820
1/4	3/8	4	1/4	2-1/8	.230	—	32704	32729
1/4	3/8	4	1/4	2-1/8	.230	.010	32757	32821
1/4	3/8	4	1/4	2-1/8	.230	.030	32758	32822
5/16	7/16	4	5/16	1-1/8	.292	—	32705	32730
5/16	7/16	4	5/16	1-1/8	.292	.030	32759	32823
5/16	7/16	4	5/16	2-1/8	.292	—	32706	32731
5/16	7/16	4	5/16	2-1/8	.292	.030	32760	32824
3/8	1/2	3	3/8	1-1/8	.355	.015	35791	36239
3/8	1/2	3	3/8	1-1/8	.355	.090	35792	36240
3/8	1/2	4	3/8	1-1/8	.355	—	32707	32732
3/8	1/2	4	3/8	1-1/8	.355	.030	32762	32826
3/8	1/2	4	3/8	1-1/8	.355	.060	32763	32827
3/8	1/2	4	3/8	2-1/8	.355	—	32708	32733
3/8	1/2	4	3/8	2-1/8	.355	.030	32764	32828
3/8	1/2	4	3/8	2-1/8	.355	.060	32765	32829
1/2	5/8	3	1/2	1-3/8	.480	.015	35795	36243
1/2	5/8	4	1/2	1-3/8	.480	—	32709	32734
1/2	5/8	4	1/2	1-3/8	.480	.030	32767	32831
1/2	5/8	4	1/2	1-3/8	.480	.060	32768	32832
1/2	5/8	4	1/2	1-3/8	.480	.090	32769	32833
1/2	5/8	4	1/2	1-3/8	.480	.120	32770	32834
1/2	5/8	4	1/2	2-1/4	.480	.015	35796	36244

TOLERANCES (inch)

- 1/8–3/16 DIAMETER**
DC = +0.0000/–0.00032
DCON = h₆
RE = +0.0000/–0.0020
- 1/4–3/8 DIAMETER**
DC = +0.0000/–0.00035
DCON = h₆
RE = +0.0000/–0.0020
- 1/2–5/8 DIAMETER**
DC = +0.0000/–0.00043
DCON = h₆
RE = +0.0000/–0.0020
- 3/4–1 DIAMETER**
DC = +0.0000/–0.00051
DCON = h₆
RE = +0.0000/–0.0020

- NON-FERROUS
- PLASTICS/COMPOSITES

For patent information visit www.ksptpatents.com

continued on next page

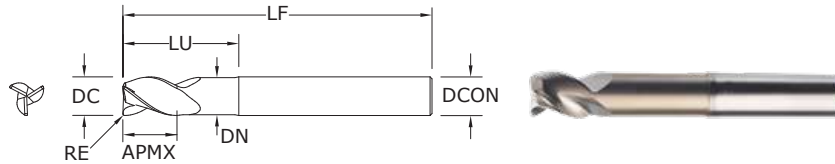
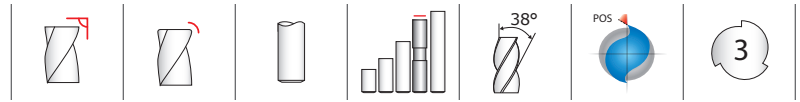

**43L •
43LC**
FRACTIONAL SERIES

CONTINUED

TOLERANCES (inch)

1/8–3/16 DIAMETER

DC = +0.0000/–0.00032

DCON = h₆

RE = +0.0000/–0.0020

1/4–3/8 DIAMETER

DC = +0.0000/–0.00035

DCON = h₆

RE = +0.0000/–0.0020

1/2–5/8 DIAMETER

DC = +0.0000/–0.00043

DCON = h₆

RE = +0.0000/–0.0020

3/4–1 DIAMETER

DC = +0.0000/–0.00051

DCON = h₆

RE = +0.0000/–0.0020

NON-FERROUS

PLASTICS/COMPOSITES

For patent
information visit
www.ksptpatents.com

CUTTING DIAMETER DC	LENGTH OF CUT APMX	OVERALL LENGTH LF	inch				CORNER RADIUS RE	EDP NO.	
			SHANK DIAMETER DCON	REACH LU	NECK DIAMETER DN	UNCOATED		Ti-NAMITE-B (TiB ₂)	
1/2	5/8	6	1/2	2-1/8	.480	–	32710	32735	
1/2	5/8	6	1/2	2-1/8	.480	.030	32771	32835	
1/2	5/8	6	1/2	2-1/8	.480	.060	32772	32836	
1/2	5/8	6	1/2	2-1/8	.480	.090	32773	32837	
1/2	5/8	6	1/2	2-1/8	.480	.120	32774	32838	
1/2	5/8	6	1/2	3-3/8	.480	–	32711	32736	
1/2	5/8	6	1/2	3-3/8	.480	.030	32775	32839	
1/2	5/8	6	1/2	3-3/8	.480	.060	32776	32840	
1/2	5/8	6	1/2	3-3/8	.480	.090	32777	32841	
1/2	5/8	6	1/2	3-3/8	.480	.120	32778	32842	
1/2	5/8	6	1/2	4-1/4	.480	–	32697	34894	
5/8	3/4	4	5/8	1-3/4	.605	–	32712	32737	
5/8	3/4	4	5/8	1-3/4	.605	.030	32779	32843	
5/8	3/4	4	5/8	1-3/4	.605	.060	32780	32844	
5/8	3/4	4	5/8	1-3/4	.605	.090	32781	32845	
5/8	3/4	4	5/8	1-3/4	.605	.120	32782	32846	
5/8	3/4	4	5/8	2-3/8	.605	–	32713	32738	
5/8	3/4	4	5/8	2-3/8	.605	.030	32783	32847	
5/8	3/4	4	5/8	2-3/8	.605	.060	32784	32848	
5/8	3/4	4	5/8	2-3/8	.605	.090	32785	32849	
5/8	3/4	4	5/8	2-3/8	.605	.120	32786	32850	
5/8	3/4	6	5/8	3-3/8	.605	–	32714	32739	
5/8	3/4	6	5/8	3-3/8	.605	.030	32787	32851	
5/8	3/4	6	5/8	3-3/8	.605	.060	32788	32852	
5/8	3/4	6	5/8	3-3/8	.605	.090	32789	32853	
5/8	3/4	6	5/8	3-3/8	.605	.120	32790	32854	
5/8	3/4	6	5/8	4-3/8	.605	–	32698	34895	
3/4	1	4	3/4	1-3/4	.730	–	32715	32740	
3/4	1	4	3/4	1-3/4	.730	.030	32791	32855	
3/4	1	4	3/4	1-3/4	.730	.060	32792	32856	
3/4	1	4	3/4	1-3/4	.730	.090	32793	32857	
3/4	1	4	3/4	1-3/4	.730	.120	32794	32858	
3/4	1	4	3/4	2	.730	.190	35803	36251	
3/4	1	4	3/4	2	.730	.250	35804	36252	
3/4	1	6	3/4	2-3/8	.730	–	32716	32741	
3/4	1	6	3/4	2-3/8	.730	.030	32795	32859	

continued on next page

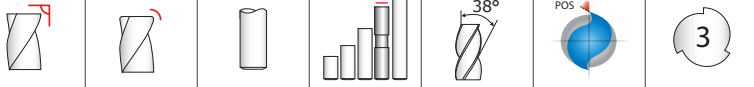

**43L •
43LC**

FRACTIONAL SERIES

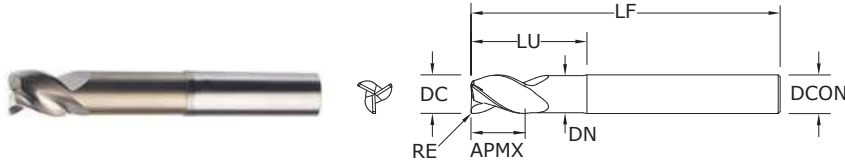

CONTINUED

CUTTING DIAMETER DC	LENGTH OF CUT APMX	OVERALL LENGTH LF	inch				EDP NO.	
			SHANK DIAMETER DCON	REACH LU	NECK DIAMETER DN	CORNER RADIUS RE	UNCOATED	Ti-NAMITE-B (TiB ₂)
3/4	1	6	3/4	2-3/8	.730	.060	32796	32860
3/4	1	6	3/4	2-3/8	.730	.090	32797	32861
3/4	1	6	3/4	2-3/8	.730	.120	32798	32862
3/4	1	6	3/4	3-3/8	.730	—	32717	32742
3/4	1	6	3/4	3-3/8	.730	.030	32799	32863
3/4	1	6	3/4	3-3/8	.730	.060	32800	32864
3/4	1	6	3/4	3-3/8	.730	.090	32801	32865
3/4	1	6	3/4	3-3/8	.730	.120	32802	32866
3/4	1	6	3/4	4-3/8	.730	—	32699	34896
1	1-1/4	5	1	2-5/8	.980	.190	35809	36257
1	1-1/4	5	1	2-5/8	.980	.250	35810	36258
1	1-1/4	6	1	2-3/8	.980	—	32718	32743
1	1-1/4	6	1	2-3/8	.980	.030	32803	32867
1	1-1/4	6	1	2-3/8	.980	.060	32804	32868
1	1-1/4	6	1	2-3/8	.980	.090	32805	32869
1	1-1/4	6	1	2-3/8	.980	.120	32806	32870
1	1-1/4	6	1	3-3/8	.980	—	32719	32744
1	1-1/4	6	1	3-3/8	.980	.030	32807	32871
1	1-1/4	6	1	3-3/8	.980	.060	32808	32872
1	1-1/4	6	1	3-3/8	.980	.090	32809	32873
1	1-1/4	6	1	3-3/8	.980	.120	32810	32874
1	1-1/4	6	1	3-3/8	.980	.190	35811	36259
1	1-1/4	6	1	3-3/8	.980	.250	35812	36260
1	1-1/4	7	1	4-3/8	.980	—	32720	32745

TOLERANCES (inch)

- 1/8–3/16 DIAMETER**
DC = +0.0000/–0.00032
DCON = h₆
RE = +0.0000/–0.0020
- 1/4–3/8 DIAMETER**
DC = +0.0000/–0.00035
DCON = h₆
RE = +0.0000/–0.0020
- 1/2–5/8 DIAMETER**
DC = +0.0000/–0.00043
DCON = h₆
RE = +0.0000/–0.0020
- 3/4–1 DIAMETER**
DC = +0.0000/–0.00051
DCON = h₆
RE = +0.0000/–0.0020

- NON-FERROUS
- PLASTICS/COMPOSITES

For patent information visit www.ksptpatents.com

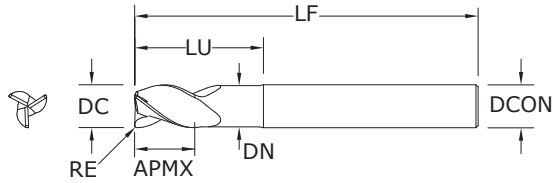
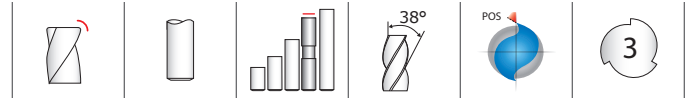

43EC
FRACTIONAL SERIES

TOLERANCES (inch)

1/4–3/8 DIAMETER

DC = +0.0000/–0.00035

DCON = h_6

RE = +0.0000/–0.0020

1/2–5/8 DIAMETER

DC = +0.0000/–0.00043

DCON = h_6

RE = +0.0000/–0.0020

3/4–1 DIAMETER

DC = +0.0000/–0.00051

DCON = h_6

RE = +0.0000/–0.0020

NON-FERROUS

PLASTICS/COMPOSITES

For patent information visit www.ksptpatents.com

CUTTING DIAMETER DC	LENGTH OF CUT APMX	OVERALL LENGTH LF	inch				EDP NO.	
			SHANK DIAMETER DCON	REACH LU	NECK DIAMETER DN	CORNER RADIUS RE	UNCOATED	Ti-NAMITE-B (TiB ₂)
1/4	3/8	3	1/4	1-1/8	.230	.015	35789	36237
1/4	3/8	3	1/4	1-1/8	.230	.060	35790	36238
3/8	1/2	4	3/8	2-1/8	.355	.015	35793	36241
3/8	1/2	4	3/8	2-1/8	.355	.090	35794	36242
1/2	5/8	5	1/2	3-3/8	.480	.015	35797	36245
1/2	5/8	6	1/2	4-1/4	.480	.015	35798	36246
1/2	5/8	6	1/2	4-1/4	.480	.030	35799	36247
1/2	5/8	6	1/2	4-1/4	.480	.060	35800	36248
1/2	5/8	6	1/2	4-1/4	.480	.090	35801	36249
1/2	5/8	6	1/2	4-1/4	.480	.120	35802	36250
3/4	1	6	3/4	3-3/8	.730	.190	35805	36253
3/4	1	6	3/4	3-3/8	.730	.250	35806	36254
1	1-1/4	7	1	4-3/8	.980	.030	35813	36261
1	1-1/4	7	1	4-3/8	.980	.060	35814	36262
1	1-1/4	7	1	4-3/8	.980	.090	35815	36263
1	1-1/4	7	1	4-3/8	.980	.120	35816	36264
1	1-1/4	7	1	4-3/8	.980	.190	35817	36265
1	1-1/4	7	1	4-3/8	.980	.250	35818	36266

- Circular land allows for increased control at various speed and feed rates and reduces chatter
- Symmetrical end gashing for excellent balance at high speeds and aggressive plunging capability
- Open fluting for deep slotting and profiling
- Necked design with blended diameter transitions provide clearance to reach
- Enhanced corner geometry with tight tolerance corner radii
- Recommended for materials ≤ 150 Bhn (≤ 7 HRC)

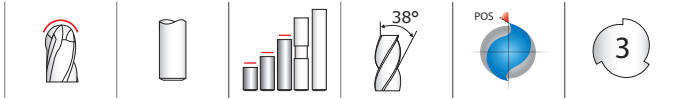

43B
FRACTIONAL SERIES

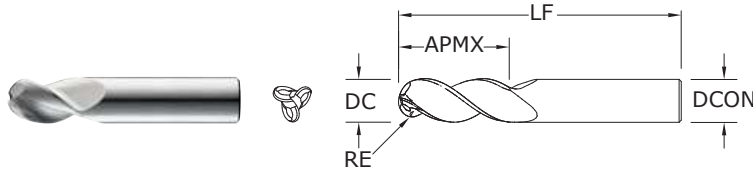

- Circular land allows for increased control at various speed and feed rates and reduces chatter
- Open fluting for deep slotting and profiling
- Ball nose design ideal for finishing operations in complex workpieces
- Recommended for materials ≤ 150 Bhn (≤ 7 HRC)

CUTTING DIAMETER DC	inch			EDP NO.	
	LENGTH OF CUT APMX	OVERALL LENGTH LF	SHANK DIAMETER DCON	UNCOATED	Ti-NAMITE-B (TiB ₂)
1/4	3/8	2	1/4	34916	34972
1/4	3/4	2-1/2	1/4	34917	34973
1/4	1	3	1/4	34918	34974
3/8	1/2	2	3/8	34919	34975
3/8	1	2-1/2	3/8	34920	34976
3/8	1-1/2	3-1/2	3/8	34921	34977
1/2	5/8	2-1/2	1/2	34922	34978
1/2	1	3	1/2	34923	34979
1/2	1-1/4	3	1/2	34924	34980
1/2	1-5/8	4	1/2	34925	34981
1/2	2	4	1/2	34926	34982
5/8	3/4	3	5/8	34927	34983
5/8	1-5/8	4	5/8	34928	34984
3/4	1	3	3/4	34929	34985
3/4	1-5/8	4	3/4	34930	34986
3/4	2-1/4	5	3/4	34931	34987
1	1-1/4	4	1	34932	34988
1	2	5	1	34933	34989
1	3-1/4	6	1	34934	34990

RE = 1/2 Cutting Diameter (DC)

TOLERANCES (inch)

- 1/4–3/8 DIAMETER**
 DC = +0.0000/–0.00035
 DCON = h₆
 RE = +0.0005/–0.0005
- 1/2–5/8 DIAMETER**
 DC = +0.0000/–0.00043
 DCON = h₆
 RE = +0.0005/–0.0005
- 3/4–1 DIAMETER**
 DC = +0.0000/–0.00051
 DCON = h₆
 RE = +0.0005/–0.0005

- NON-FERROUS
- PLASTICS/COMPOSITES

For patent information visit www.ksptpatents.com

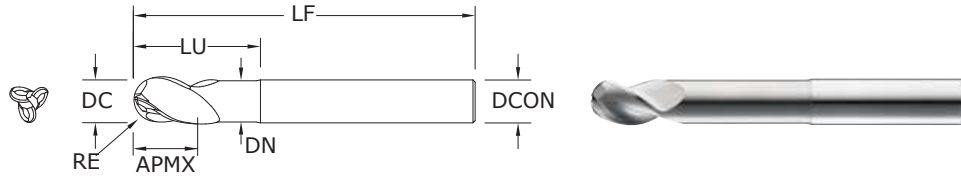
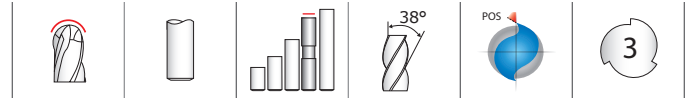

43LB
FRACTIONAL SERIES

TOLERANCES (inch)

1/4–3/8 DIAMETER

DC = +0.0000/–0.00035
DCON = h_6
RE = +0.0005/–0.0005

1/2–5/8 DIAMETER

DC = +0.0000/–0.00043
DCON = h_6
RE = +0.0005/–0.0005

3/4–1 DIAMETER

DC = +0.0000/–0.00051
DCON = h_6
RE = +0.0005/–0.0005

CUTTING DIAMETER DC	LENGTH OF CUT APMX	inch				EDP NO.	
		OVERALL LENGTH LF	SHANK DIAMETER DCON	REACH LU	NECK DIAMETER DN	UNCOATED	Ti-NAMITE-B (TiB ₂)
1/4	3/8	2-1/2	1/4	3/4	.230	34941	35005
3/8	1/2	3	3/8	1-1/8	.355	34943	35007
1/2	5/8	3	1/2	1-3/8	.480	34945	35009
1/2	5/8	4	1/2	2-1/4	.480	34946	35010
5/8	3/4	4	5/8	1-5/8	.605	34949	35013
3/4	1	4	3/4	2	.730	34951	35015
1	1-1/4	5	1	2-5/8	.980	34954	35018
1	1-1/4	6	1	3-3/8	.980	34955	35019

RE = 1/2 Cutting Diameter (DC)

- Circular land allows for increased control at various speed and feed rates and reduces chatter
- Open fluting for deep slotting and profiling
- Necked design with blended diameter transitions provide clearance to reach
- Ball nose design ideal for finishing operations in complex workpieces
- Recommended for materials ≤ 150 Bhn (≤ 7 HRC)

NON-FERROUS

PLASTICS/COMPOSITES

For patent information visit www.ksptpatents.com

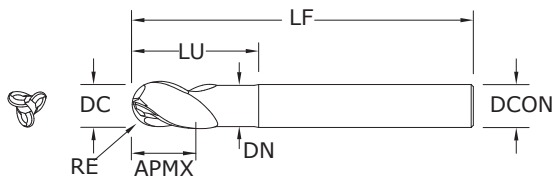
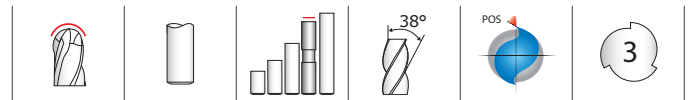

43EB
FRACTIONAL SERIES

TOLERANCES (inch)

1/4–3/8 DIAMETER

DC = +0.0000/–0.00035
DCON = h_6
RE = +0.0005/–0.0005

1/2–5/8 DIAMETER

DC = +0.0000/–0.00043
DCON = h_6
RE = +0.0005/–0.0005

3/4–1 DIAMETER

DC = +0.0000/–0.00051
DCON = h_6
RE = +0.0005/–0.0005

CUTTING DIAMETER DC	LENGTH OF CUT APMX	inch				EDP NO.	
		OVERALL LENGTH LF	SHANK DIAMETER DCON	REACH LU	NECK DIAMETER DN	UNCOATED	Ti-NAMITE-B (TiB ₂)
1/4	3/8	3	1/4	1-1/8	.230	34942	35006
3/8	1/2	4	3/8	2-1/8	.355	34944	35008
1/2	5/8	5	1/2	3-3/8	.480	34947	35011
1/2	5/8	6	1/2	4-1/4	.480	34948	35012
5/8	3/4	6	5/8	3-3/8	.605	34950	35014
3/4	1	6	3/4	3-3/8	.730	34952	35016
1	1-1/4	7	1	4-3/8	.980	34956	35020

RE = 1/2 Cutting Diameter (DC)

- Circular land allows for increased control at various speed and feed rates and reduces chatter
- Open fluting for deep slotting and profiling
- Necked design with blended diameter transitions provide clearance to reach
- Ball nose design ideal for finishing operations in complex workpieces
- Recommended for materials ≤ 150 Bhn (≤ 7 HRC)

NON-FERROUS

PLASTICS/COMPOSITES

For patent information visit www.ksptpatents.com

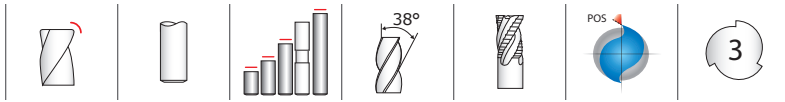

43CB
FRACTIONAL SERIES

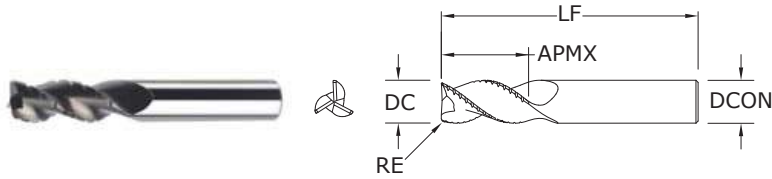

- Circular land allows for increased control at various speed and feed rates and reduces chatter
- Symmetrical end gashing for excellent balance at high speeds and aggressive plunging capability
- Chip breakers reduce machine loads up to 15% for increased roughing feed rate capability
- Open fluting for deep slotting and profiling
- Recommended for materials ≤ 150 Bhn (≤ 7 HRC)

CUTTING DIAMETER DC	LENGTH OF CUT APMX	inch			EDP NO.	
		OVERALL LENGTH LF	SHANK DIAMETER DCON	CORNER RADIUS RE	UNCOATED	Ti-NAMITE-B (TiB ₂)
1/4	3/8	2-1/2	1/4	.020	33390	33450
1/4	1/2	2-1/2	1/4	.020	33391	33451
1/4	3/4	2-1/2	1/4	.020	33392	33452
1/4	1	3	1/4	.020	33393	33453
1/4	1-1/4	3-1/2	1/4	.020	33394	33454
1/4	1-3/4	4	1/4	.020	33395	33455
5/16	7/16	2-1/2	5/16	.020	33396	33456
5/16	11/16	2-1/2	5/16	.020	33397	33457
5/16	1	3	5/16	.020	33398	33458
5/16	2-1/8	4	5/16	.020	33400	33460
3/8	1/2	3	3/8	.020	33401	33461
3/8	1	2-1/2	3/8	.020	33400	33405
3/8	1-1/4	3-1/2	3/8	.020	33402	33462
3/8	1-1/2	4	3/8	.020	33403	33463
3/8	2	4	3/8	.020	33404	33464
1/2	5/8	3	1/2	.030	33406	33466
1/2	1	3	1/2	.030	33407	33467
1/2	1-1/4	3-1/4	1/2	.030	33401	33406
1/2	1-5/8	4	1/2	.030	33408	33468
1/2	2	4	1/2	.030	33409	33469
1/2	2-1/2	5	1/2	.030	33410	33470
1/2	3-1/8	6	1/2	.030	33411	33471
5/8	3/4	3-1/2	5/8	.030	33412	33472
5/8	1-5/8	3-3/4	5/8	.030	33402	33407
5/8	2-1/8	4	5/8	.030	33413	33473
5/8	3-1/4	6	5/8	.030	33415	33475
5/8	3-3/4	6	5/8	.030	33416	33476
3/4	1	4	3/4	.030	33417	33477
3/4	1-5/8	4	3/4	.030	33403	33408
3/4	2-1/4	4	3/4	.030	33418	33478
3/4	3-1/4	6	3/4	.030	33419	33479
3/4	4	6	3/4	.030	33420	33480
1	1-1/4	5	1	.030	33421	33481
1	2	4-1/2	1	.030	33404	33409
1	2-5/8	6	1	.030	33422	33482
1	3-1/4	6	1	.030	33423	33483
1	4-1/8	7	1	.030	33424	33484

TOLERANCES (inch)

- 1/4–3/8 DIAMETER**
DC = +0.0000/–0.00035
DCON = h₆
RE = +0.0000/–0.0020
- 1/2–5/8 DIAMETER**
DC = +0.0000/–0.00043
DCON = h₆
RE = +0.0000/–0.0020
- 3/4–1 DIAMETER**
DC = +0.0000/–0.00051
DCON = h₆
RE = +0.0000/–0.0020

- NON-FERROUS
- PLASTICS/COMPOSITES

For patent information visit www.ksptpatents.com

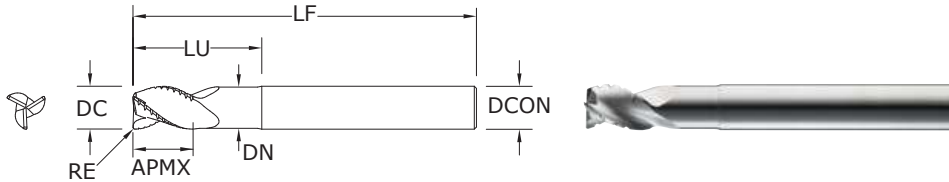

43LCB
FRACTIONAL SERIES

TOLERANCES (inch)

1/4–3/8 DIAMETER

DC = +0.0000/-0.00035

DCON = h_6

RE = +0.0000/-0.0020

1/2–5/8 DIAMETER

DC = +0.0000/-0.00043

DCON = h_6

RE = +0.0000/-0.0020

3/4–1 DIAMETER

DC = +0.0000/-0.00051

DCON = h_6

RE = +0.0000/-0.0020

NON-FERROUS

PLASTICS/COMPOSITES

For patent information visit www.ksptpatents.com

CUTTING DIAMETER DC	LENGTH OF CUT APMX	OVERALL LENGTH LF	inch				CORNER RADIUS RE	EDP NO.	
			SHANK DIAMETER DCON	REACH LU	NECK DIAMETER DN	UNCOATED		Ti-NAMITE-B (TiB ₂)	
1/4	3/8	4	1/4	3/4	.230	.020	33500	33540	
1/4	3/8	4	1/4	1-1/8	.230	.020	33501	33541	
1/4	3/8	4	1/4	2-1/8	.230	.020	33502	33542	
5/16	7/16	4	5/16	1-1/8	.292	.020	33503	33543	
5/16	7/16	4	5/16	2-1/8	.292	.020	33504	33544	
3/8	1/2	4	3/8	1-1/8	.355	.020	33507	33547	
3/8	1/2	4	3/8	2-1/8	.355	.020	33508	33548	
1/2	5/8	4	1/2	1-3/8	.480	.030	33511	33551	
1/2	5/8	4	1/2	2-1/4	.480	.030	—	33552	
1/2	5/8	6	1/2	3-3/8	.480	.030	33513	33553	
1/2	5/8	6	1/2	4-1/4	.480	.030	33514	33554	
5/8	3/4	4	5/8	1-5/8	.605	.030	33515	33555	
5/8	3/4	6	5/8	2-3/8	.605	.030	33516	33556	
5/8	3/4	6	5/8	3-3/8	.605	.030	33517	33557	
5/8	3/4	6	5/8	4-3/8	.605	.030	33518	33558	
3/4	1	4	3/4	2	.730	.030	33519	33559	
3/4	1	6	3/4	2-1/2	.730	.030	33520	33560	
3/4	1	6	3/4	3-3/8	.730	.030	33521	33561	
3/4	1	6	3/4	4-3/8	.730	.030	33522	33562	
1	1-1/4	6	1	2-5/8	.980	.030	33523	33563	
1	1-1/4	6	1	3-3/8	.980	.030	33524	33564	
1	1-1/4	7	1	4-3/8	.980	.030	33525	33565	

- Circular land allows for increased control at various speed and feed rates and reduces chatter
- Symmetrical end gashing for excellent balance at high speeds and aggressive plunging capability
- Chip breakers reduce machine loads up to 15% for increased roughing feed rate capability
- Open fluting for deep slotting and profiling
- Necked design with blended diameter transitions provide clearance to reach
- Recommended for materials ≤ 150 Bhn (≤ 7 HRC)

Series
43CR, 43CB, 43LC,
43, 43L, 43LCB, 43B,
43LB, 43ELB, 43EC
Fractional

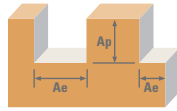

Material	Hardness	Ae x DC	Ap x DC	Vc (sfm)	DC • in							
					1/8	1/4	3/8	1/2	5/8	3/4	1	
ALUMINUM ALLOYS 2024, 5052, 5086, 6061, 6073, 7075	Slot 	1	≤ 1	1600	RPM	48896	24448	16299	12224	9779	8149	6112
				(1280-1920)	Fz	0.0009	0.0025	0.0045	0.0060	0.0065	0.0070	0.0085
					Feed (ipm)	132	183	220	220	191	171	156
	Profile 	≤ 0.5	≤ 1.5	2000	RPM	61120	30560	20373	15280	12224	10187	7640
				(1600-2400)	Fz	0.0009	0.0025	0.0045	0.0060	0.0065	0.0070	0.0085
					Feed (ipm)	165	229	275	275	238	214	195
	HSM 	≤ 0.05	≤ 2	3300	RPM	100848	50424	33616	25212	20170	16808	12606
				(2640-3960)	Fz	0.0021	0.0055	0.0105	0.0140	0.0150	0.0165	0.0195
					Feed (ipm)	635	832	1059	1059	908	832	737
ALUMINUM DIE CAST ALLOYS (HIGH SILICONE) A-390, A-392, B-390	Slot 	1	≤ 1	600	RPM	18336	9168	6112	4584	3667	3056	2292
				(480-720)	Fz	0.0009	0.0025	0.0045	0.0060	0.0065	0.0070	0.0085
					Feed (ipm)	50	69	83	83	72	64	58
	Profile 	≤ 0.5	≤ 1.5	750	RPM	22920	11460	7640	5730	4584	3820	2865
				(600-900)	Fz	0.0009	0.0025	0.0045	0.0060	0.0065	0.0070	0.0085
					Feed (ipm)	62	86	103	103	89	80	73
	HSM 	≤ 0.05	≤ 2	1240	RPM	37894	18947	12631	9474	7579	6316	4737
				(992-1488)	Fz	0.0021	0.0055	0.0105	0.0140	0.0150	0.0165	0.0195
					Feed (ipm)	239	313	398	398	341	313	277
COPPER ALLOYS Aluminum Bronze Brass Naval Brass Red Brass	Slot 	1	≤ 1	865	RPM	26434	13217	8811	6609	5287	4406	3304
				(692-1038)	Fz	0.0008	0.0020	0.0040	0.0050	0.0055	0.0060	0.0070
					Feed (ipm)	63	79	106	99	87	79	69
	Profile 	≤ 0.5	≤ 1.5	1080	RPM	33005	16502	11002	8251	6601	5501	4126
				(864-1296)	Fz	0.0008	0.0020	0.0040	0.0050	0.0055	0.0060	0.0070
					Feed (ipm)	79	99	132	124	109	99	87
	HSM 	≤ 0.05	≤ 2	1780	RPM	54397	27198	18132	13599	10879	9066	6800
				(1424-2136)	Fz	0.0017	0.0045	0.0085	0.0115	0.0125	0.0140	0.0160
					Feed (ipm)	277	367	462	469	408	381	326
COPPER ALLOYS Beryllium Copper C110, Malleable Bronze, Tin Bronze	Slot 	1	≤ 1	345	RPM	10543	5272	3514	2636	2109	1757	1318
				(276-414)	Fz	0.0008	0.0020	0.0040	0.0050	0.0055	0.0060	0.0070
					Feed (ipm)	25	32	42	40	35	32	28
	Profile 	≤ 0.5	≤ 1.5	430	RPM	13141	6570	4380	3285	2628	2190	1643
				(344-516)	Fz	0.0008	0.0020	0.0040	0.0050	0.0055	0.0060	0.0070
					Feed (ipm)	32	39	53	49	43	39	34
	HSM 	≤ 0.05	≤ 2	710	RPM	21698	10849	7233	5424	4340	3616	2712
				(568-852)	Fz	0.0017	0.0045	0.0085	0.0115	0.0125	0.0140	0.0160
					Feed (ipm)	111	146	184	187	163	152	130
PLASTICS ABS, Polycarbonate, PVC, Polypropylene	Slot 	1	≤ 1	1600	RPM	48896	24448	16299	12224	9779	8149	6112
				(1280-1920)	Fz	0.0015	0.0040	0.0075	0.0100	0.0110	0.0120	0.0140
					Feed (ipm)	220	293	367	367	323	293	257
	Profile 	≤ 0.5	≤ 1.5	2000	RPM	61120	30560	20373	15280	12224	10187	7640
				(1600-2400)	Fz	0.0015	0.0040	0.0075	0.0100	0.0110	0.0120	0.0140
					Feed (ipm)	275	367	458	458	403	367	321
	HSM 	≤ 0.05	≤ 2	3300	RPM	100848	50424	33616	25212	20170	16808	12606
				(2640-3960)	Fz	0.0034	0.0090	0.0170	0.0230	0.0250	0.0275	0.0320
					Feed (ipm)	1029	1361	1714	1740	1513	1387	1210

Bhn (Brinell) HRC (Rockwell C) HRB (Rockwell B) HSM (High Speed Machining)
 $rpm = Vc \times 3.82 / DC$
 $ipm = Fz \times 3 \times rpm$
 reduce speed and feed for materials harder than listed
 reduce cut depth and feed by 50% for long flute and long reach tools
 reduce feed and Ae when finish milling (.02 x DC maximum)
 refer to the SGS Tool Wizard® for complete technical information (www.kyocera-sgstool.com)

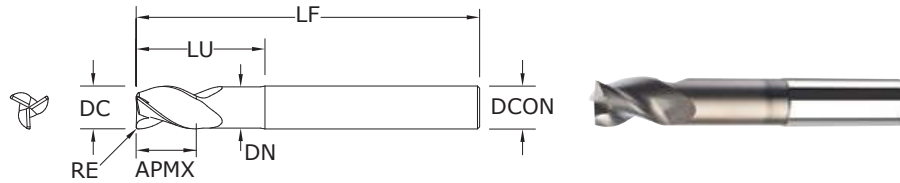
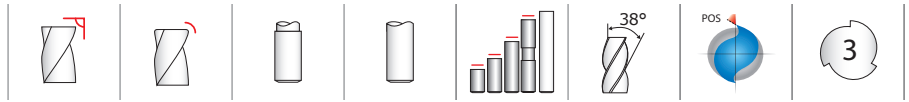

**43M •
43MCR**
METRIC SERIES

TOLERANCES (mm)

6 DIAMETER

DC = +0,000/-0,008

DCON = h₆

RE = +0,000/-0,050

>6-10 DIAMETER

DC = +0,000/-0,009

DCON = h₆

RE = +0,000/-0,050

>10-18 DIAMETER

DC = +0,000/-0,011

DCON = h₆

RE = +0,000/-0,050

>18-20 DIAMETER

DC = +0,000/-0,013

DCON = h₆

RE = +0,000/-0,050

NON-FERROUS

PLASTICS/COMPOSITES

For patent information visit www.ksptpatents.com

mm								EDP NO.	
CUTTING DIAMETER DC	LENGTH OF CUT APMX	OVERALL LENGTH LF	SHANK DIAMETER DCON	CORNER RADIUS RE	REACH LU	NECK DIAMETER DN	POLISHED FLUTE	UNCOATED Ti-NAMITE-B (TiB ₂)	
3,0	8,0	52,0	6,0	—	—	—	•	—	44890
4,0	11,0	55,0	6,0	—	—	—	•	—	44891
5,0	13,0	57,0	6,0	—	—	—	•	—	44892
6,0	13,0	57,0	6,0	—	—	—	•	44701	44715
6,0	13,0	57,0	6,0	1,5	—	—	•	—	44732
6,0	13,0	57,0	6,0	0,5	—	—	•	—	44902
6,0	13,0	57,0	6,0	1,0	—	—	•	—	44894
6,0	13,0	72,0	6,0	—	—	—	•	44702	44716
6,0	13,0	72,0	6,0	0,8	—	—	•	—	44842
6,0	13,0	72,0	6,0	1,2	—	—	•	—	44843
6,0	24,0	75,0	6,0	—	—	—	•	—	44893
6,0	24,0	75,0	6,0	0,5	—	—	•	—	44844
6,0	24,0	75,0	6,0	1,0	—	—	•	—	44845
8,0	19,0	63,0	8,0	—	—	—	•	44703	44717
8,0	19,0	63,0	8,0	0,3	—	—	•	—	44846
8,0	19,0	63,0	8,0	0,5	—	—	•	—	44847
8,0	19,0	63,0	8,0	1,0	—	—	•	—	44848
8,0	19,0	63,0	8,0	1,5	—	—	•	—	44849
8,0	32,0	75,0	8,0	—	—	—	•	—	44895
8,0	32,0	75,0	8,0	0,5	—	—	•	—	44850
8,0	32,0	75,0	8,0	1,0	—	—	•	—	44851
8,0	32,0	75,0	8,0	1,5	—	—	•	—	44852
8,0	32,0	75,0	8,0	2,0	—	—	•	—	44853
10,0	22,0	72,0	10,0	—	—	—	•	44705	44719
10,0	22,0	72,0	10,0	0,3	—	—	•	—	44854
10,0	22,0	72,0	10,0	0,5	—	—	•	—	44855
10,0	22,0	72,0	10,0	1,0	—	—	•	—	44856
10,0	22,0	72,0	10,0	1,5	—	—	•	—	44857
10,0	40,0	100,0	10,0	—	—	—	•	—	44896
10,0	40,0	100,0	10,0	0,5	—	—	•	—	44858

continued on next page

- Circular land allows for increased control at various speed and feed rates and reduces chatter
- Symmetrical end gashing for excellent balance at high speeds and aggressive plunging capability
- Open fluting for deep slotting and profiling
- Polished flutes maximize chip evacuation and provides enhanced finish
- Enhanced corner geometry with tight tolerance corner radii
- Recommended for materials ≤ 150 Bhn (≤ 7 HRC)

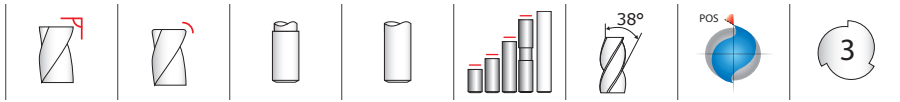

**43M •
43MCR**
METRIC SERIES

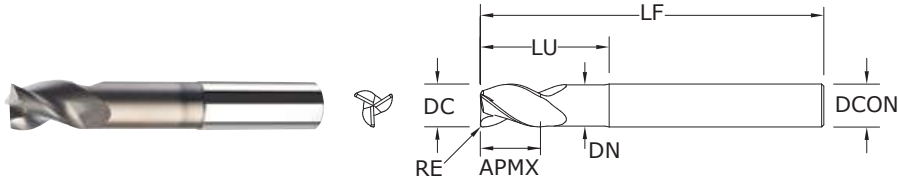

CONTINUED

mm								EDP NO.	
CUTTING DIAMETER DC	LENGTH OF CUT APMX	OVERALL LENGTH LF	SHANK DIAMETER DCON	CORNER RADIUS RE	REACH LU	NECK DIAMETER DN	POLISHED FLUTE	UNCOATED	Ti-NAMITE-B (TiB ₂)
10,0	40,0	100,0	10,0	1,0	—	—	•	—	44859
10,0	40,0	100,0	10,0	1,5	—	—	•	—	44860
10,0	40,0	100,0	10,0	2,0	—	—	•	—	44861
12,0	26,0	83,0	12,0	—	—	—	•	44708	44722
12,0	26,0	83,0	12,0	1,5	—	—	•	44814	44733
12,0	26,0	83,0	12,0	2,0	—	—	•	44815	44826
12,0	26,0	83,0	12,0	2,5	—	—	•	44816	44827
12,0	26,0	83,0	12,0	3,0	—	—	•	44817	44734
12,0	48,0	100,0	12,0	—	—	—	•	—	44897
12,0	48,0	100,0	12,0	0,5	—	—	•	—	44862
12,0	48,0	100,0	12,0	1,0	—	—	•	—	44863
12,0	48,0	100,0	12,0	1,5	—	—	•	—	44864
12,0	48,0	100,0	12,0	2,0	—	—	•	—	44865
12,0	48,0	100,0	12,0	2,5	—	—	•	—	44866
12,0	48,0	100,0	12,0	3,0	—	—	•	—	44867
14,0	30,0	89,0	14,0	—	—	—	•	—	44898
14,0	30,0	89,0	14,0	1,0	—	—	•	—	44868
14,0	30,0	89,0	14,0	2,0	—	—	•	—	44869
14,0	30,0	89,0	14,0	3,0	—	—	•	—	44870
14,0	18,0	125,0	14,0	—	45,0	13,49	•	—	44899
16,0	32,0	92,0	16,0	—	—	—	•	44711	44725
16,0	32,0	92,0	16,0	1,5	—	—	•	44818	44735
16,0	32,0	92,0	16,0	2,0	—	—	•	44819	44828
16,0	32,0	92,0	16,0	2,5	—	—	•	44820	44829
16,0	32,0	92,0	16,0	3,0	—	—	•	44821	44736
16,0	32,0	92,0	16,0	4,0	—	—	•	—	44871
16,0	64,0	125,0	16,0	—	—	—	•	—	44900
16,0	64,0	125,0	16,0	0,5	—	—	•	—	44872
16,0	64,0	125,0	16,0	1,0	—	—	•	—	44873
16,0	64,0	125,0	16,0	1,5	—	—	•	—	44874
16,0	64,0	125,0	16,0	2,0	—	—	•	—	44875
16,0	64,0	125,0	16,0	2,5	—	—	•	—	44876

continued on next page

TOLERANCES (mm)

6 DIAMETER

DC = +0,000/-0,008

DCON = h₆

RE = +0,000/-0,050

>6-10 DIAMETER

DC = +0,000/-0,009

DCON = h₆

RE = +0,000/-0,050

>10-18 DIAMETER

DC = +0,000/-0,011

DCON = h₆

RE = +0,000/-0,050

>18-20 DIAMETER

DC = +0,000/-0,013

DCON = h₆

RE = +0,000/-0,050

NON-FERROUS

PLASTICS/COMPOSITES

For patent information visit www.ksptpatents.com

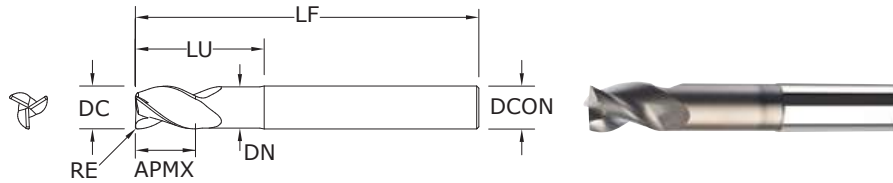
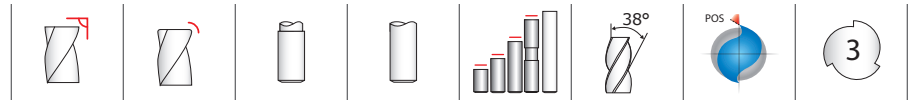

**43M •
43MCR**
METRIC SERIES

mm								EDP NO.	
CUTTING DIAMETER DC	LENGTH OF CUT APMX	OVERALL LENGTH LF	SHANK DIAMETER DCON	CORNER RADIUS RE	REACH LU	NECK DIAMETER DN	POLISHED FLUTE	UNCOATED Ti-NAMITE-B (TiB ₂)	
16,0	64,0	125,0	16,0	3,0	—	—	•	—	44877
16,0	64,0	125,0	16,0	4,0	—	—	•	—	44878
20,0	38,0	104,0	20,0	—	—	—		44714	44728
20,0	38,0	104,0	20,0	2,0	—	—		44822	44830
20,0	38,0	104,0	20,0	2,5	—	—		44823	44831
20,0	38,0	104,0	20,0	3,0	—	—		44824	44737
20,0	38,0	104,0	20,0	4,0	—	—	•	—	44879
20,0	80,0	150,0	20,0	—	—	—	•	—	44901
20,0	80,0	150,0	20,0	0,5	—	—	•	—	44880
20,0	80,0	150,0	20,0	1,0	—	—	•	—	44881
20,0	80,0	150,0	20,0	1,5	—	—	•	—	44882
20,0	80,0	150,0	20,0	2,0	—	—	•	—	44883
20,0	80,0	150,0	20,0	2,5	—	—	•	—	44884
20,0	80,0	150,0	20,0	3,0	—	—	•	—	44885
20,0	80,0	150,0	20,0	4,0	—	—	•	—	44886
25,0	50,0	125,0	25,0	—	—	—		—	44731

CONTINUED

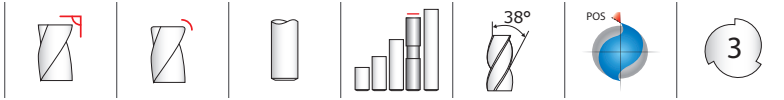

**43ML •
43MLC**
METRIC SERIES

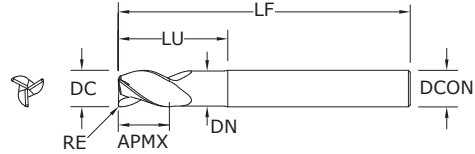

- Circular land allows for increased control at various speed and feed rates and reduces chatter
- Symmetrical end gashing for excellent balance at high speeds and aggressive plunging capability
- Open fluting for deep slotting and profiling
- Polished flutes maximize chip evacuation and provides enhanced finish
- Necked design with blended diameter transitions provide clearance to reach
- Enhanced corner geometry with tight tolerance corner radii
- Recommended for materials ≤ 150 Bhn (≤ 7 HRC)

CUTTING DIAMETER DC	LENGTH OF CUT APMX	OVERALL LENGTH LF	mm					POLISHED FLUTE	EDP NO.	
			SHANK DIAMETER DCON	REACH LU	NECK DIAMETER DN	CORNER RADIUS RE	UNCOATED		Ti-NAMITE-B (TiB ₂)	
6,0	10,0	63,0	6,0	20,0	5,49	0,5		44769	44789	
6,0	10,0	63,0	6,0	20,0	5,49	1,0		44770	44790	
6,0	10,0	75,0	6,0	20,0	5,49	—		—	42706	
6,0	13,0	72,0	6,0	30,0	5,49	0,5		44771	44791	
6,0	13,0	72,0	6,0	30,0	5,49	1,0		44772	44792	
8,0	12,0	75,0	8,0	25,0	7,49	—		—	44792	
8,0	12,0	75,0	8,0	25,0	7,49	—		—	42707	
8,0	12,0	75,0	8,0	25,0	7,49	0,3		44773	44793	
8,0	12,0	75,0	8,0	25,0	7,49	0,5		44774	44794	
8,0	12,0	75,0	8,0	25,0	7,49	0,8	•	—	44950	
8,0	12,0	75,0	8,0	25,0	7,49	1,0		44775	44795	
8,0	12,0	75,0	8,0	25,0	7,49	1,2	•	—	44951	
8,0	12,0	75,0	8,0	25,0	7,49	1,5		44776	44796	
8,0	12,0	75,0	8,0	25,0	7,49	1,6	•	—	44952	
10,0	14,0	100,0	10,0	35,0	9,48	—		—	42708	
10,0	14,0	100,0	10,0	35,0	9,48	0,3		44777	44797	
10,0	14,0	100,0	10,0	35,0	9,48	0,5		44778	44798	
10,0	14,0	100,0	10,0	35,0	9,48	1,0		44779	44799	
10,0	14,0	100,0	10,0	35,0	9,48	1,5		44780	44800	
10,0	14,0	100,0	10,0	35,0	9,50	0,8	•	—	44953	
10,0	14,0	100,0	10,0	35,0	9,50	1,2	•	—	44954	
10,0	14,0	100,0	10,0	35,0	9,50	1,6	•	—	44955	
10,0	14,0	100,0	10,0	35,0	9,50	2,4	•	—	44956	
12,0	16,0	100,0	12,0	40,0	11,48	—		—	42709	
12,0	16,0	100,0	12,0	40,0	11,48	0,5		44781	44801	
12,0	16,0	100,0	12,0	40,0	11,48	0,8	•	—	44957	
12,0	16,0	100,0	12,0	40,0	11,48	1,0		44782	44802	
12,0	16,0	100,0	12,0	40,0	11,48	1,2	•	—	44958	
12,0	16,0	100,0	12,0	40,0	11,48	1,5		44783	44803	
12,0	16,0	100,0	12,0	40,0	11,48	1,6	•	—	44959	
12,0	16,0	100,0	12,0	40,0	11,48	2,0		44784	44804	
12,0	16,0	100,0	12,0	40,0	11,48	2,4	•	—	44960	
12,0	16,0	100,0	12,0	40,0	11,48	2,5		44832	44839	
12,0	16,0	100,0	12,0	40,0	11,48	3,0		44833	44738	

TOLERANCES (mm)

6 DIAMETER

DC = +0,000/-0,008
DCON = h₆

>6-10 DIAMETER

DC = +0,000/-0,009
DCON = h₆
RE = +0,000/-0,050

>10-18 DIAMETER

DC = +0,000/-0,011
DCON = h₆
RE = +0,000/-0,050

>18-20 DIAMETER

DC = +0,000/-0,013
DCON = h₆
RE = +0,000/-0,050

- NON-FERROUS
- PLASTICS/COMPOSITES

For patent information visit www.kspatents.com

continued on next page

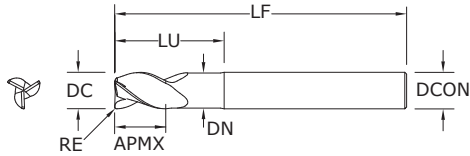
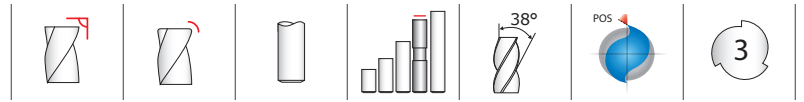

**43ML •
43MLC**
METRIC SERIES

CUTTING DIAMETER DC	LENGTH OF CUT APMX	OVERALL LENGTH LF	SHANK DIAMETER DCON	mm				EDP NO.	
				REACH LU	NECK DIAMETER DN	CORNER RADIUS RE	POLISHED FLUTE	UNCOATED	Ti-NAMITE-B (TiB ₂)
12,0	16,0	100,0	12,0	40,0	11,48	4,0		44834	44741
14,0	18,0	125,0	14,0	45,0	13,49	1,0	•	–	44961
14,0	18,0	125,0	14,0	45,0	13,49	2,0	•	–	44962
14,0	18,0	125,0	14,0	45,0	13,49	3,0	•	–	44963
14,0	18,0	125,0	14,0	45,0	13,49	4,0	•	–	44964
16,0	20,0	125,0	16,0	50,0	15,47	–		–	42710
16,0	20,0	125,0	16,0	50,0	15,47	2,0		44785	44805
16,0	20,0	125,0	16,0	50,0	15,47	2,5		44835	44840
16,0	20,0	125,0	16,0	50,0	15,47	3,0		44836	44739
16,0	20,0	125,0	16,0	50,0	15,47	4,0		44786	44806
16,0	20,0	125,0	16,0	50,0	15,49	0,8	•	–	44965
16,0	20,0	125,0	16,0	50,0	15,49	1,2	•	–	44966
16,0	20,0	125,0	16,0	50,0	15,49	1,6	•	–	44967
16,0	20,0	125,0	16,0	50,0	15,49	2,4	•	–	44968
16,0	20,0	125,0	16,0	50,0	15,49	3,2	•	–	44969
20,0	25,0	150,0	20,0	65,0	19,46	–		–	42711
20,0	25,0	150,0	20,0	65,0	19,46	2,0		44787	44807
20,0	25,0	150,0	20,0	65,0	19,46	2,4	•	–	44973
20,0	25,0	150,0	20,0	65,0	19,46	2,5		44837	44841
20,0	25,0	150,0	20,0	65,0	19,46	3,0		44838	44740
20,0	25,0	150,0	20,0	65,0	19,46	4,0		44788	44808
20,0	25,0	150,0	20,0	65,0	19,48	0,8	•	–	44970
20,0	25,0	150,0	20,0	65,0	19,48	1,2	•	–	44971
20,0	25,0	150,0	20,0	65,0	19,48	1,6	•	–	44972
20,0	25,0	150,0	20,0	65,0	19,48	3,2	•	–	44974

CONTINUED

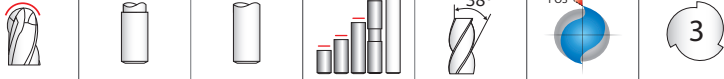

43MB
METRIC SERIES

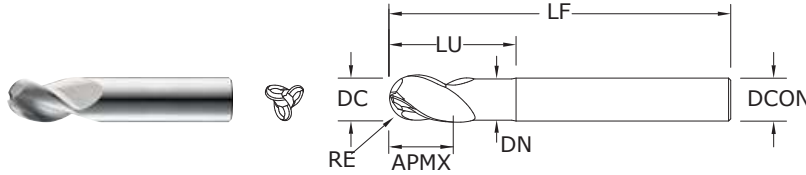

- Circular land allows for increased control at various speed and feed rates and reduces chatter
- Open fluting for deep slotting and profiling
- Polished flutes maximize chip evacuation and provides enhanced finish
- Ball nose design ideal for finishing operations in complex workpieces
- Recommended for materials ≤ 150 Bhn (≤ 7 HRC)

CUTTING DIAMETER DC	LENGTH OF CUT APMX	OVERALL LENGTH LF	mm				POLISHED FLUTE	EDP NO. Ti-NAMITE-B (TiB ₂)
			SHANK DIAMETER DCON	REACH LU	NECK DIAMETER DN			
3,0	4,5	57,0	6,0	—	—	•	44916	
3,0	6,0	57,0	6,0	10,0	2,74	•	44917	
3,0	9,0	57,0	6,0	16,0	2,74	•	44918	
4,0	6,0	57,0	6,0	—	—	•	44919	
4,0	8,0	57,0	6,0	13,0	3,73	•	44920	
4,0	12,0	57,0	6,0	21,0	3,73	•	44921	
5,0	7,5	57,0	6,0	—	—	•	44922	
5,0	10,0	63,0	6,0	16,0	4,50	•	44923	
5,0	15,0	63,0	6,0	26,0	4,50	•	44924	
6,0	9,0	57,0	6,0	—	—	•	44925	
6,0	12,0	63,0	6,0	19,0	5,49	•	44926	
6,0	18,0	75,0	6,0	31,0	5,49	•	44927	
8,0	12,0	63,0	8,0	—	—	•	44928	
8,0	16,0	75,0	8,0	25,0	7,49	•	44929	
8,0	24,0	83,0	8,0	41,0	7,49	•	44930	
10,0	15,0	75,0	10,0	—	—	•	44931	
10,0	20,0	83,0	10,0	31,0	9,50	•	44932	
10,0	30,0	100,0	10,0	51,0	9,50	•	44933	
12,0	18,0	83,0	12,0	—	—	•	44934	
12,0	24,0	100,0	12,0	37,0	11,48	•	44935	
12,0	36,0	130,0	12,0	61,0	11,48	•	44936	
16,0	24,0	100,0	16,0	—	—	•	44937	
16,0	32,0	130,0	16,0	49,0	15,49	•	44938	
16,0	48,0	150,0	16,0	81,0	15,49	•	44939	
20,0	30,0	108,0	20,0	—	—	•	44940	
20,0	40,0	130,0	20,0	61,0	19,48	•	44941	
20,0	60,0	150,0	20,0	101,0	19,48	•	44942	
25,0	37,5	127,0	25,0	—	—	•	44943	
25,0	50,0	152,0	25,0	76,0	24,49	•	44944	
25,0	75,0	170,0	25,0	126,0	24,49	•	44945	

RE = 1/2 Cutting Diameter (DC)

TOLERANCES (mm)

3 DIAMETER

DC = +0,000/-0,006
DCON = h₆
RE = +0,0127/-0,0127

>3-6 DIAMETER

DC = +0,000/-0,008
DCON = h₆
RE = +0,0127/-0,0127

>6-10 DIAMETER

DC = +0,000/-0,009
DCON = h₆
RE = +0,0127/-0,0127

>10-18 DIAMETER

DC = +0,000/-0,011
DCON = h₆
RE = +0,0127/-0,0127

>18-25 DIAMETER

DC = +0,000/-0,013
DCON = h₆
RE = +0,0127/-0,0127

NON-FERROUS
PLASTICS/COMPOSITES

For patent information visit www.ksptpatents.com

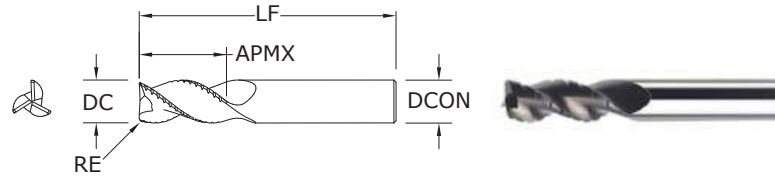

43MCB
METRIC SERIES

TOLERANCES (mm)

>6–10 DIAMETER

DC = +0,000/–0,009

DCON = h₆

RE = +0,000/–0,050

>10–18 DIAMETER

DC = +0,000/–0,011

DCON = h₆

RE = +0,000/–0,050

>18–20 DIAMETER

DC = +0,000/–0,013

DCON = h₆

RE = +0,000/–0,050

NON-FERROUS

PLASTICS/COMPOSITES

For patent information visit
www.ksptpatents.com

CUTTING DIAMETER DC	LENGTH OF CUT APMX	mm			EDP NO.	
		OVERALL LENGTH LF	SHANK DIAMETER DCON	CORNER RADIUS RE	UNCOATED	Ti-NAMITE-B (TiB ₂)
6,0	19,0	63,0	6,0	0,5	44298	44299
8,0	19,0	63,0	8,0	0,3	44300	44305
10,0	22,0	72,0	10,0	0,3	44301	44306
12,0	26,0	83,0	12,0	1,0	44302	44307
16,0	32,0	92,0	16,0	1,0	44303	44308
20,0	38,0	104,0	20,0	1,0	44304	44309

- Circular land allows for increased control at various speed and feed rates and reduces chatter
- Symmetrical end gashing for excellent balance at high speeds and aggressive plunging capability
- Chip breakers reduce machine loads up to 15% for increased roughing feed rate capability
- Open fluting for deep slotting and profiling
- Recommended for materials ≤ 150 Bhn (≤ 7 HRC)

Series
43M, 43MB, 43MCR,
43ML, 43MLC,
43MCB
Metric

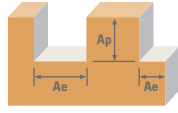

Material	Hardness	Ae x DC	Ap x DC	Vc (m/min)	DC • mm								
					3	6	10	12	16	20	25		
ALUMINUM ALLOYS 2024, 5052, 5086, 6061, 6073, 7075	≤ 150 Bhn or ≤ 7 HRc	Slot 	1	≤ 1	490	RPM	52022	26011	15607	13005	9754	7803	6243
					(392-588)	Fz	0.022	0.060	0.120	0.144	0.166	0.187	0.213
					Feed (mm/min)	3371	4682	5618	5618	4869	4370	3980	
		Profile 	≤ 0.5	≤ 1.5	610	RPM	64762	32381	19429	16190	12143	9714	7771
					(488-732)	Fz	0.022	0.060	0.120	0.144	0.166	0.187	0.213
					Feed (mm/min)	4196	5828	6994	6994	6061	5440	4955	
		HSM 	≤ 0.05	≤ 2	1005	RPM	106698	53349	32009	26674	20006	16005	12804
					(804-1206)	Fz	0.050	0.132	0.280	0.336	0.384	0.440	0.488
					Feed (mm/min)	16131	21124	26888	26885	23046	21126	18726	
ALUMINUM DIE CAST ALLOYS (HIGH SILICONE) A-390, A-392, B-390	≤ 125 Bhn or ≤ 77 HRb	Slot 	1	≤ 1	185	RPM	19641	9820	5892	4910	3683	2946	2357
					(148-222)	Fz	0.022	0.060	0.120	0.144	0.166	0.187	0.213
					Feed (mm/min)	1273	1768	2121	2121	1838	1650	1503	
		Profile 	≤ 0.5	≤ 1.5	230	RPM	24418	12209	7326	6105	4578	3663	2930
					(184-276)	Fz	0.022	0.060	0.120	0.144	0.166	0.187	0.213
					Feed (mm/min)	1582	2197	2637	2637	2285	2051	1868	
		HSM 	≤ 0.05	≤ 2	380	RPM	40343	20172	12103	10086	7564	6052	4841
					(304-456)	Fz	0.050	0.132	0.280	0.336	0.384	0.440	0.488
					Feed (mm/min)	6099	7987	10166	10166	8714	7988	7081	
COPPER ALLOYS Aluminum Bronze Brass Naval Brass Red Brass	≤ 140 Bhn or ≤ 3 HRc	Slot 	1	≤ 1	265	RPM	28134	14067	8440	7034	5275	4220	3376
					(212-318)	Fz	0.019	0.048	0.107	0.120	0.141	0.160	0.175
					Feed (mm/min)	1620	2025	2701	2532	2228	2026	1773	
		Profile 	≤ 0.5	≤ 1.5	330	RPM	35035	17518	10511	8759	6569	5255	4204
					(264-396)	Fz	0.019	0.048	0.107	0.120	0.141	0.160	0.175
					Feed (mm/min)	2018	2522	3363	3153	2775	2523	2207	
		HSM 	≤ 0.05	≤ 2	545	RPM	57861	28930	17358	14465	10849	8679	6943
					(436-654)	Fz	0.041	0.108	0.227	0.276	0.320	0.373	0.400
					Feed (mm/min)	7082	9373	11804	11976	10415	9721	8332	
COPPER ALLOYS Beryllium Copper C110, Manganese Bronze, Tin Bronze	≤ 200 Bhn or ≤ 23 HRc	Slot 	1	≤ 1	105	RPM	11148	5574	3344	2787	2090	1672	1338
					(84-126)	Fz	0.019	0.048	0.107	0.120	0.141	0.160	0.175
					Feed (mm/min)	642	803	1070	1003	883	803	702	
		Profile 	≤ 0.5	≤ 1.5	130	RPM	13802	6901	4141	3450	2588	2070	1656
					(104-156)	Fz	0.019	0.048	0.107	0.120	0.141	0.160	0.175
					Feed (mm/min)	795	994	1325	1242	1093	994	870	
		HSM 	≤ 0.05	≤ 2	215	RPM	22826	11413	6848	5706	4280	3424	2739
					(172-258)	Fz	0.041	0.108	0.227	0.276	0.320	0.373	0.400
					Feed (mm/min)	2794	3697	4656	4725	4109	3835	3287	
PLASTICS ABS, Polycarbonate, PVC, Polypropylene		Slot 	1	≤ 1	490	RPM	52022	26011	15607	13005	9754	7803	6243
					(392-588)	Fz	0.036	0.096	0.200	0.240	0.282	0.320	0.350
					Feed (mm/min)	5618	7490	9364	9363	8240	7491	6555	
		Profile 	≤ 0.5	≤ 1.5	610	RPM	64762	32381	19429	16190	12143	9714	7771
					(488-732)	Fz	0.036	0.096	0.200	0.240	0.282	0.320	0.350
					Feed (mm/min)	6994	9325	11657	11656	10258	9326	8160	
		HSM 	≤ 0.05	≤ 2	1005	RPM	106698	53349	32009	26674	20006	16005	12804
					(804-1206)	Fz	0.082	0.216	0.453	0.552	0.640	0.733	0.800
					Feed (mm/min)	26117	34567	43532	44169	38410	35210	30730	

Bhn (Brinell) HRc (Rockwell C) HRb (Rockwell B) HSM (High Speed Machining)
 $rpm = (Vc \times 1000) / (DC \times 3.14)$
 $mm/min = Fz \times 3 \times rpm$
 reduce speed and feed for materials harder than listed
 reduce cut depth and feed by 50% for long flute and long reach tools
 reduce feed and Ae when finish milling (.02 x DC maximum)
 refer to the SGS Tool Wizard® for complete technical information (www.kyocera-sgstool.com)

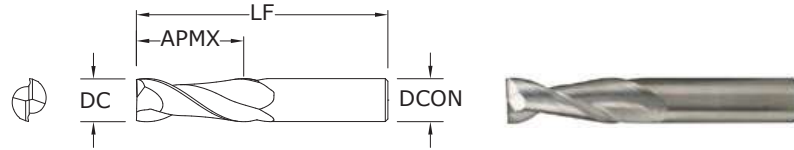
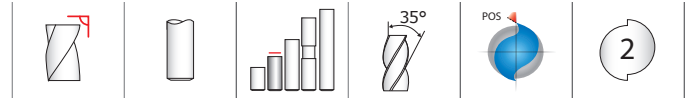

47
FRACTIONAL SERIES

TOLERANCES (inch)

1/8–3/16 DIAMETER
DC = +0.0000/–0.00032
DCON = h₆

1/4–3/8 DIAMETER
DC = +0.0000/–0.00035
DCON = h₆

1/2–5/8 DIAMETER
DC = +0.0000/–0.00043
DCON = h₆

3/4–1 DIAMETER
DC = +0.0000/–0.00051
DCON = h₆

- NON-FERROUS
- PLASTICS/COMPOSITES

For patent information visit www.ksptpatents.com

inch				EDP NO.	
CUTTING DIAMETER DC	LENGTH OF CUT APMX	OVERALL LENGTH LF	SHANK DIAMETER DCON	UNCOATED	Ti-NAMITE-B (TiB ₂)
1/8	3/8	1-1/2	1/8	34620	34660
3/16	9/16	2	3/16	34621	34661
1/4	3/4	2-1/2	1/4	34622	34662
5/16	13/16	2-1/2	5/16	34623	34663
3/8	1	2-1/2	3/8	34624	34664
1/2	1-1/4	3-1/4	1/2	34625	34665
5/8	1-5/8	3-3/4	5/8	34626	34666
3/4	1-5/8	4	3/4	34627	34667
1	2	4-1/2	1	34628	34668

- Circular land reduces edge aggressiveness for varied speed and feed rates
- 2 Flutes effectively manage the large size and volume of chips produced during the aggressive machining process
- Excellent balance at high speeds and aggressive plunging capability
- Recommended for materials ≤ 150 Bhn (≤ 7 HRc)

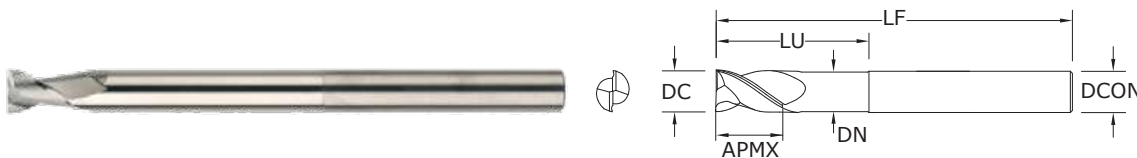
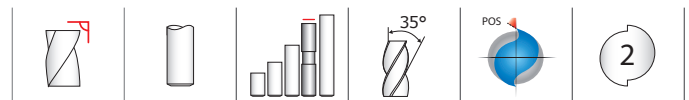

47L
FRACTIONAL SERIES

TOLERANCES (inch)

1/4–3/8 DIAMETER
DC = +0.0000/–0.00035
DCON = h₆

1/2–5/8 DIAMETER
DC = +0.0000/–0.00043
DCON = h₆

3/4–1 DIAMETER
DC = +0.0000/–0.00051
DCON = h₆

- NON-FERROUS
- PLASTICS/COMPOSITES

For patent information visit www.ksptpatents.com

inch						EDP NO.	
CUTTING DIAMETER DC	LENGTH OF CUT APMX	OVERALL LENGTH LF	SHANK DIAMETER DCON	REACH LU	NECK DIAMETER DN	UNCOATED	Ti-NAMITE-B (TiB ₂)
1/4	3/8	4	1/4	2-1/8	.235	34640	34678
3/8	1/2	4	3/8	2-1/8	.360	34641	34679
1/2	5/8	6	1/2	2-1/8	.485	34642	34680
1/2	5/8	6	1/2	3-3/8	.485	34643	34681
5/8	3/4	6	5/8	2-3/8	.610	34644	34682
5/8	3/4	6	5/8	3-3/8	.610	34645	34683
3/4	1	6	3/4	2-1/2	.735	34646	34684
3/4	1	6	3/4	3-3/8	.735	34647	34685

- Circular land reduces edge aggressiveness for varied speed and feed rates
- 2 Flutes effectively manage the large size and volume of chips produced during the aggressive machining process
- Excellent balance at high speeds and aggressive plunging capability
- Necked design with blended diameter transitions provide clearance to reach
- Recommended for materials ≤ 150 Bhn (≤ 7 HRc)



47B
FRACTIONAL SERIES

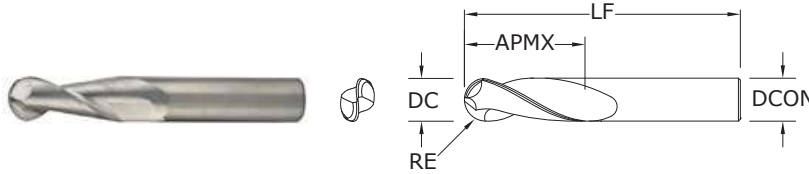

- Circular land reduces edge aggressiveness for varied speed and feed rates
- 2 Flutes effectively manage the large size and volume of chips produced during the aggressive machining process
- Excellent balance at high speeds and aggressive plunging capability
- Ball nose design ideal for finishing operations in complex workpieces
- Recommended for materials ≤ 150 Bhn (≤ 7 HRC)

CUTTING DIAMETER DC	LENGTH OF CUT APMX	OVERALL LENGTH LF	SHANK DIAMETER DCON	EDP NO.	
				UNCOATED	Ti-NAMITE-B (TiB ₂)
1/8	3/8	1-1/2	1/8	34630	34669
3/16	9/16	2	3/16	34631	34670
1/4	3/4	2-1/2	1/4	34632	34671
5/16	13/16	2-1/2	5/16	34633	34672
3/8	1	2-1/2	3/8	34634	34673
1/2	1-1/4	3-1/4	1/2	34635	34674
5/8	1-5/8	3-3/4	5/8	34636	34675
3/4	1-5/8	4	3/4	34637	34676
1	2	4-1/2	1	34638	34677

RE = 1/2 Cutting Diameter (DC)

TOLERANCES (inch)

- 1/8–3/16 DIAMETER**
DC = +0.0000/–0.00032
DCON = h₆
RE = +.0005/–.0005
- 1/4–3/8 DIAMETER**
DC = +0.0000/–0.00035
DCON = h₆
RE = +.0005/–.0005
- 1/2–5/8 DIAMETER**
DC = +0.0000/–0.00043
DCON = h₆
RE = +.0005/–.0005
- 3/4–1 DIAMETER**
DC = +0.0000/–0.00051
DCON = h₆
RE = +.0005/–.0005

NON-FERROUS
PLASTICS/COMPOSITES

For patent information visit www.ksptpatents.com



47LB
FRACTIONAL SERIES

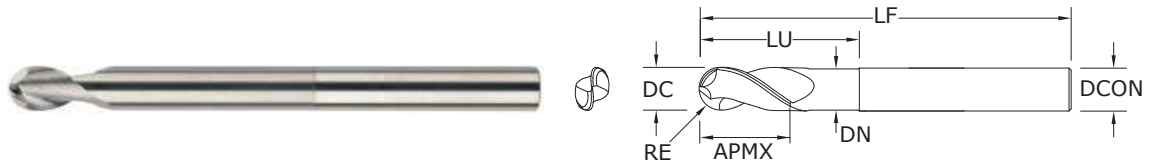

- Circular land reduces edge aggressiveness for varied speed and feed rates
- 2 Flutes effectively manage the large size and volume of chips produced during the aggressive machining process
- Excellent balance at high speeds and aggressive plunging capability
- Necked design with blended diameter transitions provide clearance to reach
- Ball nose design ideal for finishing operations in complex workpieces
- Recommended for materials ≤ 150 Bhn (≤ 7 HRC)

CUTTING DIAMETER DC	LENGTH OF CUT APMX	OVERALL LENGTH LF	SHANK DIAMETER DCON	REACH LU	NECK DIAMETER DN	EDP NO.	
						UNCOATED	Ti-NAMITE-B (TiB ₂)
1/4	3/8	4	1/4	2-1/8	.235	34650	34686
3/8	1/2	4	3/8	2-1/8	.360	34651	34687
1/2	5/8	6	1/2	2-1/8	.485	34652	34688
1/2	5/8	6	1/2	3-3/8	.485	34653	34689
5/8	3/4	6	5/8	2-3/8	.610	34655	34691
5/8	3/4	6	5/8	3-3/8	.610	34654	34690
3/4	1	6	3/4	2-1/2	.735	34656	34693
3/4	1	6	3/4	3-3/8	.735	34657	34692

RE = 1/2 Cutting Diameter (DC)

TOLERANCES (inch)

- 1/4–3/8 DIAMETER**
DC = +0.0000/–0.00035
DCON = h₆
RE = +.0005/–.0005
- 1/2–5/8 DIAMETER**
DC = +0.0000/–0.00043
DCON = h₆
RE = +.0005/–.0005
- 3/4–1 DIAMETER**
DC = +0.0000/–0.00051
DCON = h₆
RE = +.0005/–.0005

NON-FERROUS
PLASTICS/COMPOSITES

For patent information visit www.ksptpatents.com

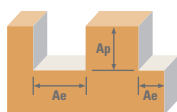

Series
47, 47B, 47L, 47LB
Fractional

Hardness

Ae x DC Ap x DC

Vc
(sfm)

DC • in

1/8 1/4 3/8 1/2 5/8 3/4 1

Material	Hardness	Ae x DC	Ap x DC	Vc (sfm)	Tool Type	DC • in							
						1/8	1/4	3/8	1/2	5/8	3/4	1	
ALUMINUM ALLOYS 2024, 5052, 5086, 6061, 6073, 7075	≤ 150 Bhn or ≤ 7 HRc	1	≤ 1	1600 (1280-1920)	Slot	RPM	48896	24448	16299	12224	9779	8149	6112
					Fz	0.0009	0.0025	0.0045	0.0060	0.0065	0.0070	0.0085	
					Feed (ipm)	88	122	147	147	127	114	104	
				2000 (1600-2400)	Slot	RPM	61120	30560	20373	15280	12224	10187	7640
					Fz	0.0009	0.0025	0.0045	0.0060	0.0065	0.0070	0.0085	
					Feed (ipm)	110	153	183	183	159	143	130	
				3300 (2640-3960)	Slot	RPM	100848	50424	33616	25212	20170	16808	12606
					Fz	0.0021	0.0055	0.0105	0.0140	0.0150	0.0165	0.0195	
					Feed (ipm)	424	555	706	706	605	555	492	
ALUMINUM DIE CAST ALLOYS (HIGH SILICONE) A-390, A-392, B- 390	≤ 125 Bhn or ≤ 77 HRb	1	≤ 1	600 (480-720)	Slot	RPM	18336	9168	6112	4584	3667	3056	2292
					Fz	0.0009	0.0025	0.0045	0.0060	0.0065	0.0070	0.0085	
					Feed (ipm)	33	46	55	55	48	43	39	
				750 (600-900)	Slot	RPM	22920	11460	7640	5730	4584	3820	2865
					Fz	0.0009	0.0025	0.0045	0.0060	0.0065	0.0070	0.0085	
					Feed (ipm)	41	57	69	69	60	53	49	
				1240 (992-1488)	Slot	RPM	37894	18947	12631	9474	7579	6316	4737
					Fz	0.0021	0.0055	0.0105	0.0140	0.0150	0.0165	0.0195	
					Feed (ipm)	159	208	265	265	227	208	185	
COPPER ALLOYS Aluminum Bronze Naval Brass Red Brass	≤ 140 Bhn or ≤ 3 HRc	1	≤ 1	865 (692-1038)	Slot	RPM	26434	13217	8811	6609	5287	4406	3304
					Fz	0.0008	0.0020	0.0040	0.0050	0.0055	0.0060	0.0070	
					Feed (ipm)	42	53	70	66	58	53	46	
				1080 (864-1296)	Slot	RPM	33005	16502	11002	8251	6601	5501	4126
					Fz	0.0008	0.0020	0.0040	0.0050	0.0055	0.0060	0.0070	
					Feed (ipm)	53	66	88	83	73	66	58	
				1780 (1424-2136)	Slot	RPM	54397	27198	18132	13599	10879	9066	6800
					Fz	0.0017	0.0045	0.0085	0.0115	0.0125	0.0140	0.0160	
					Feed (ipm)	185	245	308	313	272	254	218	
COPPER ALLOYS Beryllium Copper C110, Manganese Bronze, Tin Bronze	≤ 200 Bhn or ≤ 23 HRc	1	≤ 1	345 (276-414)	Slot	RPM	10543	5272	3514	2636	2109	1757	1318
					Fz	0.0008	0.0020	0.0040	0.0050	0.0055	0.0060	0.0070	
					Feed (ipm)	17	21	28	26	23	21	18	
				430 (344-516)	Slot	RPM	13141	6570	4380	3285	2628	2190	1643
					Fz	0.0008	0.0020	0.0040	0.0050	0.0055	0.0060	0.0070	
					Feed (ipm)	21	26	35	33	29	26	23	
				710 (568-852)	Slot	RPM	21698	10849	7233	5424	4340	3616	2712
					Fz	0.0017	0.0045	0.0085	0.0115	0.0125	0.0140	0.0160	
					Feed (ipm)	74	98	123	125	108	101	87	
PLASTICS ABS, Polycarbonate, PVC, Polypropylene		1	≤ 1	1600 (1280-1920)	Slot	RPM	48896	24448	16299	12224	9779	8149	6112
					Fz	0.0015	0.0040	0.0075	0.0100	0.0110	0.0120	0.0140	
					Feed (ipm)	147	196	244	244	215	196	171	
				2000 (1600-2400)	Slot	RPM	61120	30560	20373	15280	12224	10187	7640
					Fz	0.0015	0.0040	0.0075	0.0100	0.0110	0.0120	0.0140	
					Feed (ipm)	183	244	306	306	269	244	214	
				3300 (2640-3960)	Slot	RPM	100848	50424	33616	25212	20170	16808	12606
					Fz	0.0034	0.0090	0.0170	0.0230	0.0250	0.0275	0.0320	
					Feed (ipm)	686	908	1143	1160	1008	924	807	

Bhn (Brinell) HRc (Rockwell C) HRb (Rockwell B) HSM (High Speed Machining)
 rpm = Vc x 3.82 / DC
 ipm = Fz x 2 x rpm
 reduce speed and feed for materials harder than listed
 reduce cut depth and feed by 50% for long flute and long reach tools
 reduce feed and Ae when finish milling (.02 x DC maximum)
 refer to the SGS Tool Wizard® for complete technical information (www.kyocera-sgstool.com)



47M
METRIC SERIES

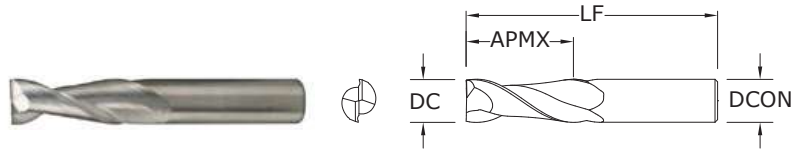

- Circular land reduces edge aggressiveness for varied speed and feed rates
- 2 Flutes effectively manage the large size and volume of chips produced during the aggressive machining process
- Excellent balance at high speeds and aggressive plunging capability
- Recommended for materials ≤ 150 Bhn (≤ 7 HRC)

mm				EDP NO.	
CUTTING DIAMETER DC	LENGTH OF CUT APMX	OVERALL LENGTH LF	SHANK DIAMETER DCON	UNCOATED	Ti-NAMITE-B (TiB ₂)
3,0	8,0	38,0	3,0	44550	44587
4,0	11,0	50,0	4,0	44551	44588
5,0	13,0	50,0	5,0	44552	44589
6,0	13,0	57,0	6,0	44553	44590
8,0	19,0	63,0	8,0	44554	44591
10,0	22,0	72,0	10,0	44555	44592
12,0	26,0	83,0	12,0	44556	44593
14,0	26,0	83,0	14,0	44557	44594
16,0	32,0	92,0	16,0	44558	44595
20,0	38,0	104,0	20,0	44559	44596
25,0	38,0	104,0	25,0	44560	44597

TOLERANCES (mm)

3 DIAMETER

DC = +0,000/-0,006
DCON = h₆

>3-6 DIAMETER

DC = +0,000/-0,008
DCON = h₆

>6-10 DIAMETER

DC = +0,000/-0,009
DCON = h₆

>10-18 DIAMETER

DC = +0,000/-0,012
DCON = h₆

>18-25 DIAMETER

DC = +0,000/-0,013
DCON = h₆

NON-FERROUS

PLASTICS/COMPOSITES

For patent information visit www.ksptpatents.com

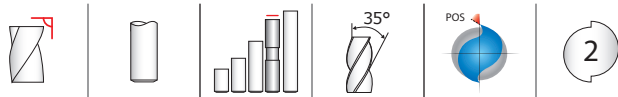

47ML
METRIC SERIES

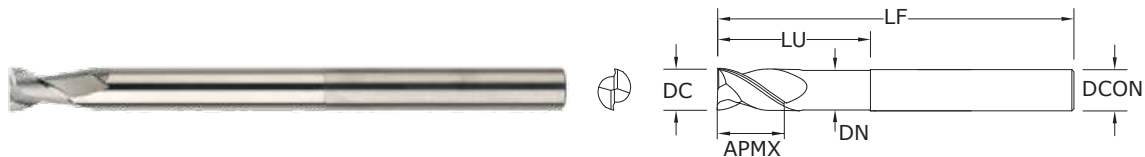

- Circular land reduces edge aggressiveness for varied speed and feed rates
- 2 Flutes effectively manage the large size and volume of chips produced during the aggressive machining process
- Excellent balance at high speeds and aggressive plunging capability
- Necked design with blended diameter transitions provide clearance to reach
- Recommended for materials ≤ 150 Bhn (≤ 7 HRC)

mm					EDP NO.		
CUTTING DIAMETER DC	LENGTH OF CUT APMX	OVERALL LENGTH LF	SHANK DIAMETER DCON	REACH LU	NECK DIAMETER DN	UNCOATED	Ti-NAMITE-B (TiB ₂)
6,0	10,0	100,0	6,0	54,0	5,62	44561	44609
8,0	12,0	100,0	8,0	54,0	7,62	44562	44610
10,0	12,0	100,0	10,0	54,0	9,62	44563	44611
12,0	16,0	150,0	12,0	80,0	11,62	44564	44612
16,0	20,0	150,0	16,0	80,0	15,62	44565	44613
20,0	25,0	150,0	20,0	80,0	19,62	44566	44614

TOLERANCES (mm)

6 DIAMETER

DC = +0,000/-0,008
DCON = h₆

>6-10 DIAMETER

DC = +0,000/-0,009
DCON = h₆

>10-18 DIAMETER

DC = +0,000/-0,011
DCON = h₆

>18-20 DIAMETER

DC = +0,000/-0,013
DCON = h₆

NON-FERROUS

PLASTICS/COMPOSITES

For patent information visit www.ksptpatents.com

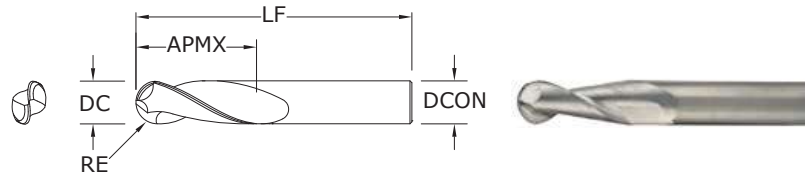
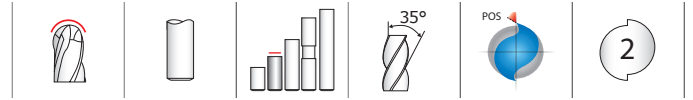

47MB
METRIC SERIES

TOLERANCES (mm)

3 DIAMETER
DC = +0,000/-0,006
DCON = h₆
RE = +0,0127/-0,0127

>3-6 DIAMETER
DC = +0,000/-0,008
DCON = h₆
RE = +0,0127/-0,0127

>6-10 DIAMETER
DC = +0,000/-0,009
DCON = h₆
RE = +0,0127/-0,0127

>10-18 DIAMETER
DC = +0,000/-0,012
DCON = h₆
RE = +0,0127/-0,0127

>18-25 DIAMETER
DC = +0,000/-0,013
DCON = h₆
RE = +0,0127/-0,0127

CUTTING DIAMETER DC	LENGTH OF CUT APMX	OVERALL LENGTH LF	SHANK DIAMETER DCON	EDP NO.	
				UNCOATED	Ti-NAMITE-B (TiB ₂)
3,0	8,0	38,0	3,0	44570	44598
4,0	11,0	50,0	4,0	44571	44599
5,0	13,0	50,0	5,0	44572	44600
6,0	13,0	57,0	6,0	44573	44601
8,0	19,0	63,0	8,0	44574	44602
10,0	22,0	72,0	10,0	44575	44603
12,0	26,0	83,0	12,0	44576	44604
14,0	26,0	83,0	14,0	44577	44605
16,0	32,0	92,0	16,0	44578	44606
20,0	37,3	104,0	20,0	44579	44607
25,0	38,0	104,0	25,0	44580	44608

- Circular land reduces edge aggressiveness for varied speed and feed rates
- 2 Flutes effectively manage the large size and volume of chips produced during the aggressive machining process
- Excellent balance at high speeds and aggressive plunging capability
- Ball nose design ideal for finishing operations in complex workpieces
- Recommended for materials ≤ 150 Bhn (≤ 7 HRC)

RE = 1/2 Cutting Diameter (DC)

NON-FERROUS
PLASTICS/COMPOSITES

For patent information visit www.ksptpatents.com

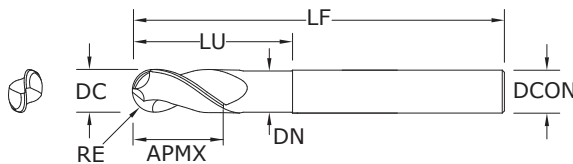
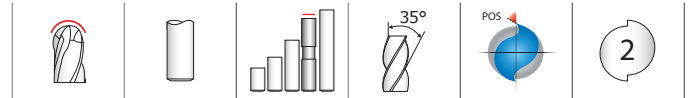

47MLB
METRIC SERIES

TOLERANCES (mm)

6 DIAMETER
DC = +0,000/-0,008
DCON = h₆
RE = +0,0127/-0,0127

>6-10 DIAMETER
DC = +0,000/-0,009
DCON = h₆
RE = +0,0127/-0,0127

>10-18 DIAMETER
DC = +0,000/-0,011
DCON = h₆
RE = +0,0127/-0,0127

>18-20 DIAMETER
DC = +0,000/-0,013
DCON = h₆
RE = +0,0127/-0,0127

CUTTING DIAMETER DC	LENGTH OF CUT APMX	OVERALL LENGTH LF	SHANK DIAMETER DCON	REACH LU	NECK DIAMETER DN	EDP NO.	
						UNCOATED	Ti-NAMITE-B (TiB ₂)
6,0	10,0	100,0	6,0	54,0	5,62	44581	44615
8,0	12,0	100,0	8,0	54,0	7,62	44582	44616
10,0	12,0	100,0	10,0	54,0	9,62	44583	44617
12,0	16,0	150,0	12,0	80,0	11,62	44584	44618
16,0	20,0	150,0	16,0	80,0	15,62	44585	44619
20,0	25,0	150,0	20,0	80,0	19,62	44586	44620

- Circular land reduces edge aggressiveness for varied speed and feed rates
- 2 Flutes effectively manage the large size and volume of chips produced during the aggressive machining process
- Excellent balance at high speeds and aggressive plunging capability
- Necked design with blended diameter transitions provide clearance to reach
- Ball nose design ideal for finishing operations in complex workpieces
- Recommended for materials ≤ 150 Bhn (≤ 7 HRC)

RE = 1/2 Cutting Diameter (DC)

NON-FERROUS
PLASTICS/COMPOSITES

For patent information visit www.ksptpatents.com

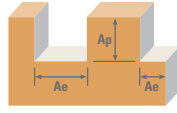

Series
47M, 47MB,
47ML, 47MLB
Metric

Series	Hardness	Ae x DC	Ap x DC	Vc (m/min)	DC • mm								
					3	6	10	12	16	20	25		
ALUMINUM ALLOYS 2024, 5052, 5086, 6061, 6073, 7075	≤ 150 Bhn or ≤ 7 HRc	Slot 	1	≤ 1	490	RPM	52022	26011	15607	13005	9754	7803	6243
					(392-588)	Fz	0.022	0.060	0.120	0.144	0.166	0.187	0.213
						Feed (mm/min)	2247	3121	3746	3745	3246	2913	2653
		Profile 	≤ 0.5	≤ 1.5	610	RPM	64762	32381	19429	16190	12143	9714	7771
					(488-732)	Fz	0.022	0.060	0.120	0.144	0.166	0.187	0.213
						Feed (mm/min)	2797	3885	4663	4662	4041	3627	3303
		HSM 	≤ 0.05	≤ 2	1005	RPM	106698	53349	32009	26674	20006	16005	12804
					(804-1206)	Fz	0.050	0.132	0.280	0.336	0.384	0.440	0.488
						Feed (mm/min)	10754	14083	17925	17924	15364	14084	12484
ALUMINUM DIE CAST ALLOYS (HIGH SILICONE) A-390, A-392, B-390	≤ 125 Bhn or ≤ 77 HRb	Slot 	1	≤ 1	185	RPM	19641	9820	5892	4910	3683	2946	2357
					(148-222)	Fz	0.022	0.060	0.120	0.144	0.166	0.187	0.213
						Feed (mm/min)	848	1178	1414	1414	1226	1100	1002
		Profile 	≤ 0.5	≤ 1.5	230	RPM	24418	12209	7326	6105	4578	3663	2930
					(184-276)	Fz	0.022	0.060	0.120	0.144	0.166	0.187	0.213
						Feed (mm/min)	1055	1465	1758	1758	1524	1367	1245
		HSM 	≤ 0.05	≤ 2	380	RPM	40343	20172	12103	10086	7564	6052	4841
					(304-456)	Fz	0.050	0.132	0.280	0.336	0.384	0.440	0.488
						Feed (mm/min)	4066	5325	6778	6777	5809	5325	4720
COPPER ALLOYS Aluminum Bronze Brass Naval Brass Red Brass	≤ 140 Bhn or ≤ 3 HRc	Slot 	1	≤ 1	265	RPM	28134	14067	8440	7034	5275	4220	3376
					(212-318)	Fz	0.019	0.048	0.107	0.120	0.141	0.160	0.175
						Feed (mm/min)	1080	1350	1801	1688	1485	1350	1182
		Profile 	≤ 0.5	≤ 1.5	330	RPM	35035	17518	10511	8759	6569	5255	4204
					(264-396)	Fz	0.019	0.048	0.107	0.120	0.141	0.160	0.175
						Feed (mm/min)	1345	1682	2242	2102	1850	1682	1472
		HSM 	≤ 0.05	≤ 2	545	RPM	57861	28930	17358	14465	10849	8679	6943
					(436-654)	Fz	0.041	0.108	0.227	0.276	0.320	0.373	0.400
						Feed (mm/min)	4721	6248	7869	7984	6943	6480	5555
COPPER ALLOYS Beryllium Copper C110, Manganese Bronze, Tin Bronze	≤ 200 Bhn or ≤ 23 HRc	Slot 	1	≤ 1	105	RPM	11148	5574	3344	2787	2090	1672	1338
					(84-126)	Fz	0.019	0.048	0.107	0.120	0.141	0.160	0.175
						Feed (mm/min)	428	535	713	669	589	535	468
		Profile 	≤ 0.5	≤ 1.5	130	RPM	13802	6901	4141	3450	2588	2070	1656
					(104-156)	Fz	0.019	0.048	0.107	0.120	0.141	0.160	0.175
						Feed (mm/min)	530	662	883	828	729	662	580
		HSM 	≤ 0.05	≤ 2	215	RPM	22826	11413	6848	5706	4280	3424	2739
					(172-258)	Fz	0.041	0.108	0.227	0.276	0.320	0.373	0.400
						Feed (mm/min)	1862	2465	3104	3150	2739	2556	2191
PLASTICS ABS, Polycarbonate, PVC, Polypropylene		Slot 	1	≤ 1	490	RPM	52022	26011	15607	13005	9754	7803	6243
					(392-588)	Fz	0.036	0.096	0.200	0.240	0.282	0.320	0.350
						Feed (mm/min)	3745	4994	6243	6242	5493	4994	4370
		Profile 	≤ 0.5	≤ 1.5	610	RPM	64762	32381	19429	16190	12143	9714	7771
					(488-732)	Fz	0.036	0.096	0.200	0.240	0.282	0.320	0.350
						Feed (mm/min)	4662	6217	7771	7771	6839	6217	5440
		HSM 	≤ 0.05	≤ 2	1005	RPM	106698	53349	32009	26674	20006	16005	12804
					(804-1206)	Fz	0.082	0.216	0.453	0.552	0.640	0.733	0.800
						Feed (mm/min)	17412	23045	29022	29446	25607	23473	20487

Bhn (Brinell) HRc (Rockwell C) HRb (Rockwell B) HSM (High Speed Machining)
 $rpm = (Vc \times 1000) / (DC \times 3.14)$
 $mm/min = Fz \times 2 \times rpm$
 reduce speed and feed for materials harder than listed
 reduce cut depth and feed by 50% for long flute and long reach tools
 reduce feed and Ae when finish milling (.02 x DC maximum)
 refer to the SGS Tool Wizard® for complete technical information (www.kyocera-sgstool.com)

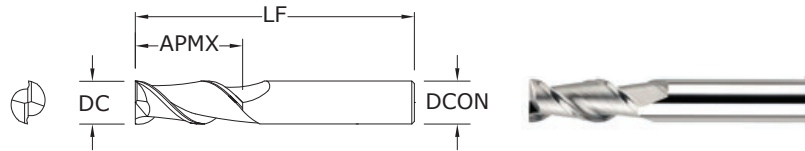
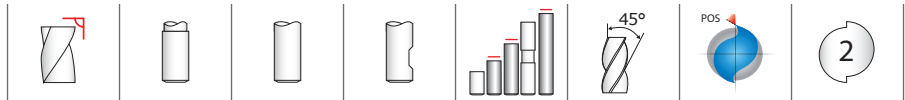

TOLERANCES (inch)

1/4–3/8 DIAMETER

DC = +0.0000/-0.00035

DCON = h₆

1/2–5/8 DIAMETER

DC = +0.0000/-0.00043

DCON = h₆

3/4–1 DIAMETER

DC = +0.0000/-0.00051

DCON = h₆

NON-FERROUS

PLASTICS/COMPOSITES

For patent information visit www.ksptpatents.com

inch				EDP NO.			
CUTTING DIAMETER DC	LENGTH OF CUT APMX	OVERALL LENGTH LF	SHANK DIAMETER DCON	UNCOATED W/FLAT	Ti-NAMITE-B (TiB ₂) W/FLAT	UNCOATED	Ti-NAMITE-B (TiB ₂)
1/4	3/4	2-7/16	3/8	34501	34502	32033	32053
1/4	1-1/4	3-1/16	3/8	34503	34504	32034	32054
1/4	1-3/4	3-9/16	3/8	34505	34506	32035	32055
5/16	1-3/8	3-1/8	3/8	34507	34508	32036	32056
3/8	3/4	2-1/2	3/8	34509	34510	32037	32057
3/8	1-1/2	3-1/4	3/8	34511	34512	32038	32058
3/8	2-1/2	4-1/4	3/8	34513	34514	32039	32059
1/2	1-1/4	3-1/4	1/2	34515	34516	32040	32060
1/2	2	4	1/2	34517	34518	32041	32061
1/2	3	5	1/2	34519	34520	32042	32062
5/8	1-5/8	3-3/4	5/8	34521	34522	32043	32063
5/8	2-1/2	4-5/8	5/8	34523	34524	32044	32064
3/4	1-5/8	3-7/8	3/4	34525	34526	32045	32065
3/4	3	5-1/4	3/4	34527	34528	32046	32066
3/4	4	6-1/4	3/4	34529	34530	32047	32067
1	2	4-1/2	1	34531	34532	32048	32068
1	4	6-1/2	1	34533	34534	32049	32069

44
FRACTIONAL SERIES

- Polished ski land with primary and secondary flute wall design minimizes chip interference by directing chips away from secondary flute
- Circular land allows for increased control at various speed and feed rates ultimately reducing chatter
- Recommended for materials ≤ 150 Bhn (≤ 7 HRC)

Contact your KSPT Sales Representative for more information on Corner Radius options.

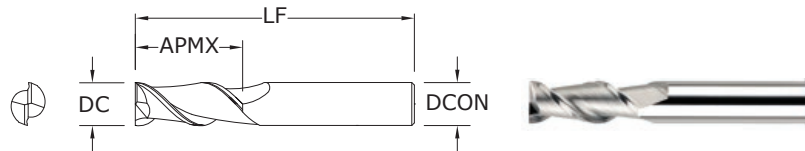

TOLERANCES (mm)

≤3 DIAMETER

DC = +0,000/-0,006

DCON = h₆

>3–6 DIAMETER

DC = +0,000/-0,008

DCON = h₆

>6–10 DIAMETER

DC = +0,000/-0,009

DCON = h₆

>10–18 DIAMETER

DC = +0,000/-0,011

DCON = h₆

>18–20 DIAMETER

DC = +0,000/-0,013

DCON = h₆

NON-FERROUS

PLASTICS/COMPOSITES

For patent information visit www.ksptpatents.com

mm				EDP NO.			
CUTTING DIAMETER DC	LENGTH OF CUT APMX	OVERALL LENGTH LF	SHANK DIAMETER DCON	UNCOATED W/FLAT	UNCOATED	Ti-NAMITE-B (TiB ₂) W/FLAT	Ti-NAMITE-B (TiB ₂)
3,0	8,0	52,0	6,0	44505	49663	44506	49674
4,0	11,0	55,0	6,0	44509	49664	44510	49675
5,0	13,0	57,0	6,0	44513	49665	44514	49676
6,0	13,0	57,0	6,0	44517	49666	44518	49677
8,0	19,0	69,0	10,0	44521	49667	44522	49678
10,0	22,0	72,0	10,0	44525	49668	44526	49679
12,0	26,0	83,0	12,0	44529	49669	44530	49680
14,0	26,0	83,0	14,0	44533	49670	44534	49681
16,0	32,0	92,0	16,0	44537	49671	44538	49682
18,0	32,0	92,0	18,0	44541	49672	44542	49683
20,0	38,0	104,0	20,0	44545	49673	44546	49684

44M
METRIC SERIES

- Polished ski land with primary and secondary flute wall design minimizes chip interference by directing chips away from secondary flute
- Circular land allows for increased control at various speed and feed rates ultimately reducing chatter
- Recommended for materials ≤ 150 Bhn (≤ 7 HRC)

Contact your KSPT Sales Representative for more information on Corner Radius options.

FRACTIONAL Ski-Carb

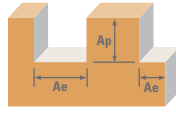

Series 44 Fractional	Hardness	Ae x DC	Ap x DC	Vc (sfm)	DC • in									
					1/8	1/4	3/8	1/2	5/8	3/4	1			
ALUMINUM ALLOYS 2024, 5052, 5086, 6061, 6073, 7075	≤ 150 Bhn or ≤ 7 HRc	Slot 	1	≤ 1	1600 (1280-1920)	RPM	48896	24448	16299	12224	9779	8149	6112	
						Fz	0.0009	0.0025	0.0045	0.0060	0.0065	0.0070	0.0085	
						Feed (ipm)	88	122	147	147	127	114	104	
		Profile 	≤ 0.5	≤ 1.5	2000 (1600-2400)	RPM	61120	30560	20373	15280	12224	10187	7640	
						Fz	0.0009	0.0025	0.0045	0.0060	0.0065	0.0070	0.0085	
						Feed (ipm)	110	153	183	183	159	143	130	
	HSM 	≤ 0.05	≤ 2	3300 (2640-3960)	RPM	100848	50424	33616	25212	20170	16808	12606		
					Fz	0.0021	0.0055	0.0105	0.0140	0.0150	0.0165	0.0195		
					Feed (ipm)	424	555	706	706	605	555	492		
	ALUMINUM DIE CAST ALLOYS (HIGH SILICONE) A-390, A-392, B-390	≤ 125 Bhn or ≤ 77 HRb	Slot 	1	≤ 1	600 (480-720)	RPM	18336	9168	6112	4584	3667	3056	2292
							Fz	0.0009	0.0025	0.0045	0.0060	0.0065	0.0070	0.0085
							Feed (ipm)	33	46	55	55	48	43	39
Profile 			≤ 0.5	≤ 1.5	750 (600-900)	RPM	22920	11460	7640	5730	4584	3820	2865	
						Fz	0.0009	0.0025	0.0045	0.0060	0.0065	0.0070	0.0085	
						Feed (ipm)	41	57	69	69	60	53	49	
HSM 		≤ 0.05	≤ 2	1240 (992-1488)	RPM	37894	18947	12631	9474	7579	6316	4737		
					Fz	0.0021	0.0055	0.0105	0.0140	0.0150	0.0165	0.0195		
					Feed (ipm)	159	208	265	265	227	208	185		
COPPER ALLOYS Aluminum Bronze Brass Naval Brass Red Brass		≤ 140 Bhn or ≤ 3 HRc	Slot 	1	≤ 1	865 (692-1038)	RPM	26434	13217	8811	6609	5287	4406	3304
							Fz	0.0008	0.0020	0.0040	0.0050	0.0055	0.0060	0.0070
							Feed (ipm)	42	53	70	66	58	53	46
	Profile 		≤ 0.5	≤ 1.5	1080 (864-1296)	RPM	33005	16502	11002	8251	6601	5501	4126	
						Fz	0.0008	0.0020	0.0040	0.0050	0.0055	0.0060	0.0070	
						Feed (ipm)	53	66	88	83	73	66	58	
	HSM 	≤ 0.05	≤ 2	1780 (1424-2136)	RPM	54397	27198	18132	13599	10879	9066	6800		
					Fz	0.0017	0.0045	0.0085	0.0115	0.0125	0.0140	0.0160		
					Feed (ipm)	185	245	308	313	272	254	218		
	COPPER ALLOYS Beryllium Copper C110, Manganese Bronze, Tin Bronze	≤ 200 Bhn or ≤ 23 HRc	Slot 	1	≤ 1	345 (276-414)	RPM	10543	5272	3514	2636	2109	1757	1318
							Fz	0.0008	0.0020	0.0040	0.0050	0.0055	0.0060	0.0070
							Feed (ipm)	17	21	28	26	23	21	18
Profile 			≤ 0.5	≤ 1.5	430 (344-516)	RPM	13141	6570	4380	3285	2628	2190	1643	
						Fz	0.0008	0.0020	0.0040	0.0050	0.0055	0.0060	0.0070	
						Feed (ipm)	21	26	35	33	29	26	23	
HSM 		≤ 0.05	≤ 2	710 (568-852)	RPM	21698	10849	7233	5424	4340	3616	2712		
					Fz	0.0017	0.0045	0.0085	0.0115	0.0125	0.0140	0.0160		
					Feed (ipm)	74	98	123	125	108	101	87		
PLASTICS ABS, Polycarbonate, PVC, Polypropylene			Slot 	1	≤ 1	1600 (1280-1920)	RPM	48896	24448	16299	12224	9779	8149	6112
							Fz	0.0015	0.0040	0.0075	0.0100	0.0110	0.0120	0.0140
							Feed (ipm)	147	196	244	244	215	196	171
	Profile 		≤ 0.5	≤ 1.5	2000 (1600-2400)	RPM	61120	30560	20373	15280	12224	10187	7640	
						Fz	0.0015	0.0040	0.0075	0.0100	0.0110	0.0120	0.0140	
						Feed (ipm)	183	244	306	306	269	244	214	
	HSM 	≤ 0.05	≤ 2	3300 (2640-3960)	RPM	100848	50424	33616	25212	20170	16808	12606		
					Fz	0.0034	0.0090	0.0170	0.0230	0.0250	0.0275	0.0320		
					Feed (ipm)	686	908	1143	1160	1008	924	807		

Bhn (Brinell) HRc (Rockwell C) HRb (Rockwell B) HSM (High Speed Machining)
 $rpm = Vc \times 3.82 / DC$
 $ipm = Fz \times 2 \times rpm$
 reduce speed and feed for materials harder than listed
 reduce cut depth and feed by 50% for long flute and long reach tools
 reduce feed and Ae when finish milling (.02 x DC maximum)
 refer to the SGS Tool Wizard® for complete technical information (www.kyocera-sgstool.com)

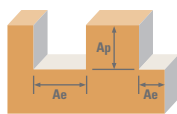

Series 44M Metric	Hardness	Ae x DC	Ap x DC	Vc (m/min)	DC • mm								
					3	6	10	12	16	20	25		
ALUMINUM ALLOYS 2024, 5052, 5086, 6061, 6073, 7075	≤ 150 Bhn or ≤ 7HRc	Slot 	1	≤ 1	490 (392-588)	RPM	52022	26011	15607	13005	9754	7803	6243
						Fz	0.022	0.060	0.120	0.144	0.166	0.187	0.213
						Feed (mm/min)	2247	3121	3746	3745	3246	2913	2653
		Profile 	≤ 0.5	≤ 1.5	610 (488-732)	RPM	64762	32381	19429	16190	12143	9714	7771
						Fz	0.022	0.060	0.120	0.144	0.166	0.187	0.213
						Feed (mm/min)	2797	3885	4663	4662	4041	3627	3303
		HSM 	≤ 0.05	≤ 2	1005 (804-1206)	RPM	106698	53349	32009	26674	20006	16005	12804
						Fz	0.050	0.132	0.280	0.336	0.384	0.440	0.488
						Feed (mm/min)	10754	14083	17925	17924	15364	14084	12484
ALUMINUM DIE CAST ALLOYS (HIGH SILICONE) A-390, A-392, B- 390	≤ 125 Bhn or ≤ 77 HRb	Slot 	1	≤ 1	185 (148-222)	RPM	19641	9820	5892	4910	3683	2946	2357
						Fz	0.022	0.060	0.120	0.144	0.166	0.187	0.213
						Feed (mm/min)	848	1178	1414	1414	1226	1100	1002
		Profile 	≤ 0.5	≤ 1.5	230 (184-276)	RPM	24418	12209	7326	6105	4578	3663	2930
						Fz	0.022	0.060	0.120	0.144	0.166	0.187	0.213
						Feed (mm/min)	1055	1465	1758	1758	1524	1367	1245
		HSM 	≤ 0.05	≤ 2	380 (304-456)	RPM	40343	20172	12103	10086	7564	6052	4841
						Fz	0.050	0.132	0.280	0.336	0.384	0.440	0.488
						Feed (mm/min)	4066	5325	6778	6777	5809	5325	4720
COPPER ALLOYS Aluminum Bronze Brass Naval Brass Red Brass	≤ 140 Bhn or ≤ 3 HRc	Slot 	1	≤ 1	265 (212-318)	RPM	28134	14067	8440	7034	5275	4220	3376
						Fz	0.019	0.048	0.107	0.120	0.141	0.160	0.175
						Feed (mm/min)	1080	1350	1801	1688	1485	1350	1182
		Profile 	≤ 0.5	≤ 1.5	330 (264-396)	RPM	35035	17518	10511	8759	6569	5255	4204
						Fz	0.019	0.048	0.107	0.120	0.141	0.160	0.175
						Feed (mm/min)	1345	1682	2242	2102	1850	1682	1472
		HSM 	≤ 0.05	≤ 2	545 (436-654)	RPM	57861	28930	17358	14465	10849	8679	6943
						Fz	0.041	0.108	0.227	0.276	0.320	0.373	0.400
						Feed (mm/min)	4721	6248	7869	7984	6943	6480	5555
COPPER ALLOYS Beryllium Copper C110, Manganese Bronze, Tin Bronze	≤ 200 Bhn or ≤ 23 HRc	Slot 	1	≤ 1	105 (84-126)	RPM	11148	5574	3344	2787	2090	1672	1338
						Fz	0.019	0.048	0.107	0.120	0.141	0.160	0.175
						Feed (mm/min)	428	535	713	669	589	535	468
		Profile 	≤ 0.5	≤ 1.5	130 (104-156)	RPM	13802	6901	4141	3450	2588	2070	1656
						Fz	0.019	0.048	0.107	0.120	0.141	0.160	0.175
						Feed (mm/min)	530	662	883	828	729	662	580
		HSM 	≤ 0.05	≤ 2	215 (172-258)	RPM	22826	11413	6848	5706	4280	3424	2739
						Fz	0.041	0.108	0.227	0.276	0.320	0.373	0.400
						Feed (mm/min)	1862	2465	3104	3150	2739	2556	2191
PLASTICS ABS, Polycarbonate, PVC, Polypropylene		Slot 	1	≤ 1	490 (392-588)	RPM	52022	26011	15607	13005	9754	7803	6243
						Fz	0.036	0.096	0.200	0.240	0.282	0.320	0.350
						Feed (mm/min)	3745	4994	6243	6242	5493	4994	4370
		Profile 	≤ 0.5	≤ 1.5	610 (488-732)	RPM	64762	32381	19429	16190	12143	9714	7771
						Fz	0.036	0.096	0.200	0.240	0.282	0.320	0.350
						Feed (mm/min)	4662	6217	7771	7771	6839	6217	5440
		HSM 	≤ 0.05	≤ 2	1005 (804-1206)	RPM	106698	53349	32009	26674	20006	16005	12804
						Fz	0.082	0.216	0.453	0.552	0.640	0.733	0.800
						Feed (mm/min)	17412	23045	29022	29446	25607	23473	20487

Bhn (Brinell) HRc (Rockwell C) HRb (Rockwell B) HSM (High Speed Machining)
 $rpm = (Vc \times 1000) / (DC \times 3.14)$
 $mm/min = Fz \times 2 \times rpm$
 reduce speed and feed for materials harder than listed
 reduce cut depth and feed by 50% for long flute and long reach tools
 reduce feed and Ae when finish milling (.02 x DC maximum)
 refer to the SGS Tool Wizard® for complete technical information (www.kyocera-sgstool.com)

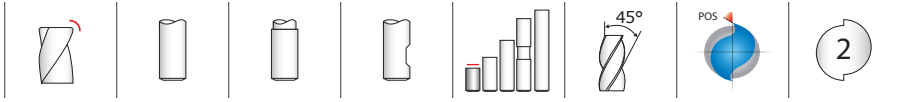

45
FRACTIONAL SERIES

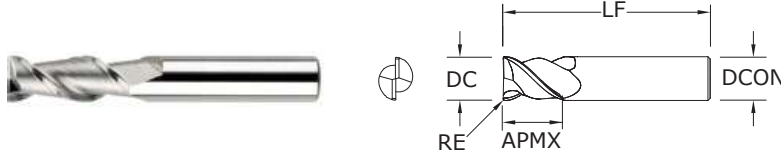

- Polished ski land with primary and secondary flute wall design minimizes chip interference by directing chips away from secondary flute
- Circular land allows for increased control at various speed and feed rates ultimately reducing chatter
- Recommended for materials ≤ 150 Bhn (≤ 7 HRC)

CUTTING DIAMETER DC	LENGTH OF CUT APMX	inch			EDP NO.			
		OVERALL LENGTH LF	SHANK DIAMETER DCON	CORNER RADIUS RE	UNCOATED W/FLAT	UNCOATED	Ti-NAMITE-B (TiB ₂) W/FLAT	Ti-NAMITE-B (TiB ₂)
1/4	3/8	2-1/2	3/8	.010	91257	91250	91242	91235
5/16	7/16	2-1/2	3/8	.012	91258	91251	91243	91236
3/8	9/16	2-1/2	3/8	.015	91259	91252	91244	91237
1/2	3/4	3	1/2	.020	91260	91253	91245	91238
5/8	7/8	3-1/2	5/8	.025	91261	91254	91246	91239
3/4	1	4	3/4	.030	91262	91255	91247	91240
1	1-1/4	4	1	.040	91263	91256	91248	91241

Contact your KSPT representative for reach options.

TOLERANCES (inch)

- 1/4–3/8 DIAMETER**
 DC = +0.0000/–0.00035
 DCON = h₆
 RE = +0.0000/–0.0020
- 1/2–5/8 DIAMETER**
 DC = +0.0000/–0.00043
 DCON = h₆
 RE = +0.0000/–0.0020
- 3/4–1 DIAMETER**
 DC = +0.0000/–0.00051
 DCON = h₆
 RE = +0.0000/–0.0020

- NON-FERROUS
- PLASTICS/COMPOSITES

For patent information visit www.ksptpatents.com

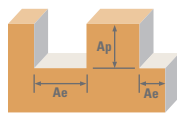

Series 45 Fractional	Hardness	Ae x DC	Ap x DC	Vc (sfm)	DC • in							
					1/4	3/8	1/2	5/8	3/4	1		
ALUMINUM ALLOYS 2024, 5052, 5086, 6061, 6073, 7075	≤ 150 Bhn or ≤ 7 HRc	Slot 	1	≤ 1	1600	RPM	24448	16299	12224	9779	8149	6112
					(1280-1920)	Fz	0.0025	0.0045	0.0060	0.0065	0.0070	0.0085
					Feed (ipm)	122	147	147	127	114	104	
	Profile 	≤ 0.5	≤ 1.5	2000	RPM	30560	20373	15280	12224	10187	7640	
				(1600-2400)	Fz	0.0025	0.0045	0.0060	0.0065	0.0070	0.0085	
				Feed (ipm)	153	183	183	159	143	130		
	HSM 	≤ 0.05	≤ 2	3300	RPM	50424	33616	25212	20170	16808	12606	
				(2640-3960)	Fz	0.0055	0.0105	0.0140	0.0150	0.0165	0.0195	
				Feed (ipm)	555	706	706	605	555	492		
ALUMINUM DIE CAST ALLOYS (HIGH SILICONE) A-390, A-392, B- 390	≤ 125 Bhn or ≤ 77 HRb	Slot 	1	≤ 1	600	RPM	9168	6112	4584	3667	3056	2292
					(480-720)	Fz	0.0025	0.0045	0.0060	0.0065	0.0070	0.0085
					Feed (ipm)	46	55	55	48	43	39	
	Profile 	≤ 0.5	≤ 1.5	750	RPM	11460	7640	5730	4584	3820	2865	
				(600-900)	Fz	0.0025	0.0045	0.0060	0.0065	0.0070	0.0085	
				Feed (ipm)	57	69	69	60	53	49		
	HSM 	≤ 0.05	≤ 2	1240	RPM	18947	12631	9474	7579	6316	4737	
				(992-1488)	Fz	0.0055	0.0105	0.0140	0.0150	0.0165	0.0195	
				Feed (ipm)	208	265	265	227	208	185		
COPPER ALLOYS Aluminum Bronze Brass Naval Brass Red Brass	≤ 140 Bhn or ≤ 3 HRc	Slot 	1	≤ 1	865	RPM	13217	8811	6609	5287	4406	3304
					(692-1038)	Fz	0.0020	0.0040	0.0050	0.0055	0.0060	0.0070
					Feed (ipm)	53	70	66	58	53	46	
	Profile 	≤ 0.5	≤ 1.5	1080	RPM	16502	11002	8251	6601	5501	4126	
				(864-1296)	Fz	0.0020	0.0040	0.0050	0.0055	0.0060	0.0070	
				Feed (ipm)	66	88	83	73	66	58		
	HSM 	≤ 0.05	≤ 2	1780	RPM	27198	18132	13599	10879	9066	6800	
				(1424-2136)	Fz	0.0045	0.0085	0.0115	0.0125	0.0140	0.0160	
				Feed (ipm)	245	308	313	272	254	218		
COPPER ALLOYS Beryllium Copper C110, Manganese Bronze, Tin Bronze	≤ 200 Bhn or ≤ 23 HRc	Slot 	1	≤ 1	345	RPM	5272	3514	2636	2109	1757	1318
					(276-414)	Fz	0.0020	0.0040	0.0050	0.0055	0.0060	0.0070
					Feed (ipm)	21	28	26	23	21	18	
	Profile 	≤ 0.5	≤ 1.5	430	RPM	6570	4380	3285	2628	2190	1643	
				(344-516)	Fz	0.0020	0.0040	0.0050	0.0055	0.0060	0.0070	
				Feed (ipm)	26	35	33	29	26	23		
	HSM 	≤ 0.05	≤ 2	710	RPM	10849	7233	5424	4340	3616	2712	
				(568-852)	Fz	0.0045	0.0085	0.0115	0.0125	0.0140	0.0160	
				Feed (ipm)	98	123	125	108	101	87		
PLASTICS ABS, Polycarbonate, PVC, Polypropylene	≤ 150 Bhn or ≤ 7 HRc	Slot 	1	≤ 1	1600	RPM	24448	16299	12224	9779	8149	6112
					(1280-1920)	Fz	0.0040	0.0075	0.0100	0.0110	0.0120	0.0140
					Feed (ipm)	196	244	244	215	196	171	
	Profile 	≤ 0.5	≤ 1.5	2000	RPM	30560	20373	15280	12224	10187	7640	
				(1600-2400)	Fz	0.0040	0.0075	0.0100	0.0110	0.0120	0.0140	
				Feed (ipm)	244	306	306	269	244	214		
	HSM 	≤ 0.05	≤ 2	3300	RPM	50424	33616	25212	20170	16808	12606	
				(2640-3960)	Fz	0.0090	0.0170	0.0230	0.0250	0.0275	0.0320	
				Feed (ipm)	908	1143	1160	1008	924	807		

Bhn (Brinell) HRc (Rockwell C) HRb (Rockwell B) HSM (High Speed Machining)
 $rpm = Vc \times 3.82 / DC$
 $ipm = Fz \times 2 \times rpm$
 reduce speed and feed for materials harder than listed
 reduce cut depth and feed by 50% for long flute and long reach tools
 reduce feed and Ae when finish milling (.02 x DC maximum)
 refer to the SGS Tool Wizard® for complete technical information (www.kyocera-sgtool.com)

General Purpose End Mills





Milling

SERIES	GENERAL PURPOSE END MILLS DESCRIPTION	PAGE
3	2 Flute Square End Standard Length Fractional	176
3L	2 Flute Square End Long Reach Fractional	176
3EL	2 Flute Square End Extended Length Fractional	176
3CR	2 Flute Corner Radius Standard Length Fractional	176
3M	2 Flute Square End Standard Length Metric	179
3XLM	2 Flute Square End Extra Long Reach Metric	179
3B	2 Flute Ball End Standard Length Fractional	180
3LB	2 Flute Ball End Long Reach Fractional	180
3ELB	2 Flute Ball End Extended Length Fractional	180
3MB	2 Flute Ball End Standard Length Metric	182
3XLMB	2 Flute Ball End Extra Long Reach Metric	182
15	2 Flute Double End Square Stub Fractional	183
15M	2 Flute Double End Square Stub Metric	183
15B	2 Flute Double End Ball Stub Fractional	184
15MB	2 Flute Double End Ball Stub Metric	184
17	2 Flute Square End Stub Fractional	185
17M	2 Flute Square End Stub Metric	185
52	2 Flute High Shear Square End Standard Length Fractional	186
52M	2 Flute High Shear Square End Standard Length Metric	186
59	2 Flute Square End Long Reach Fractional	187
59M	2 Flute Square End Long Reach Metric	187
59B	2 Flute Ball End Long Reach Fractional	188
59MB	2 Flute Ball End Long Reach Metric	188
5	3 Flute Square End Standard Length Fractional	189
5M	3 Flute Square End Standard Length Metric	190
5XLM	3 Flute Square End Extra Long Reach Metric	190
5B	3 Flute Ball End Standard Length Fractional	191
5MB	3 Flute Ball End Standard Length Metric	192
5XLMB	3 Flute Ball End Extra Long Reach Metric	192
23	3 Flute Tapered Square End Standard Length Fractional	193
24	3 Flute Tapered Corner Radius Standard Length Fractional	194
1	4 Flute Square End Standard Length Fractional	195
1L	4 Flute Square End Long Reach Fractional	195
1EL	4 Flute Square End Extended Length Fractional	195
1CR	4 Flute Corner Radius Standard Length Fractional	195
1M	4 Flute Square End Standard Length Metric	199
1XLM	4 Flute Square End Extra Long Reach Metric	199
1MCR	4 Flute Corner Radius Standard Length Metric	199

Speed & Feed Recommendations listed at the end of this section

SERIES	GENERAL PURPOSE END MILLS DESCRIPTION	PAGE
1B	4 Flute Ball End Standard Length Fractional	201
1LB	4 Flute Ball End Long Reach Fractional	201
1ELB	4 Flute Ball End Extended Length Fractional	201
1MB	4 Flute Ball End Standard Length Metric	202
1XLMB	4 Flute Ball End Extra Long Reach Metric	202
14	4 Flute Double End Square Stub Fractional	203
14M	4 Flute Double End Square Stub Metric	203
14B	4 Flute Double End Ball Stub Fractional	204
14MB	4 Flute Double End Ball Stub Metric	204
16	4 Flute Square End Stub Fractional	205
16M	4 Flute Square End Stub Metric	205
54	4 Flute High Shear Square End Standard Length Fractional	206
54M	4 Flute High Shear Square End Standard Length Metric	206
61	Multi-Flute Coarse Pitch Rougher Fractional	207
61M	Multi-Flute Coarse Pitch Rougher Metric	207
62	Multi-Flute Fine Pitch Rougher Fractional	208
62M	Multi-Flute Fine Pitch Rougher Metric	209
End Mill Sets	2, 3, & 4 Flute Square End Series 1, 3, 5, 14, 15	210
	2, 3, & 4 Flute Ball End Series 1B, 3B, 5B, 14B ,15B	211

Speed & Feed Recommendations listed at the end of this section

Fresado

SERIE	DESCRIPCIÓN DE FRESAS DE USO GENERAL	PÁGINA
3	2 filos, punta cuadrada, longitud estándar, fraccional	176
3L	2 filos, punta cuadrada, largo alcance, fraccional	176
3EL	2 filos, punta cuadrada, longitud extendida, fraccional	176
3CR	2 filos, radio angulado, longitud estándar, fraccional	176
3M	2 filos, punta cuadrada, longitud estándar, métrico	179
3XLM	2 filos, punta cuadrada, alcance extralargo, métrico	179
3B	2 filos, punta esférica, longitud estándar, fraccional	180
3LB	2 filos, punta esférica, largo alcance, fraccional	180
3ELB	2 filos, punta esférica, longitud extendida, fraccional	180
3MB	2 filos, punta esférica, longitud estándar, métrico	182
3XLMB	2 filos, punta esférica, alcance extralargo, métrico	182
15	2 filos, pieza doble de punta cuadrada, fraccional	183
15M	2 filos, pieza doble de punta cuadrada, métrico	183
15B	2 filos, pieza doble de punta esférica, fraccional	184
15MB	2 filos, pieza doble de punta esférica, métrico	184
17	2 filos, pieza de punta cuadrada, fraccional	185

SERIE	DESCRIPCIÓN DE FRESAS DE USO GENERAL	PÁGINA
17M	2 filos, pieza de punta cuadrada, métrico	185
52	2 filos, alto rendimiento, punta cuadrada, longitud estándar, fraccional	186
52M	2 filos, alto rendimiento, punta cuadrada, longitud estándar, métrico	186
59	2 filos, punta cuadrada, largo alcance, fraccional	187
59M	2 filos, punta cuadrada, largo alcance, métrico	187
59B	2 filos, punta esférica, largo alcance, fraccional	188
59MB	2 filos, punta esférica, largo alcance, métrico	188
5	3 filos, punta cuadrada, longitud estándar, fraccional	189
5M	3 filos, punta cuadrada, longitud estándar, métrico	190
5XLM	3 filos, punta cuadrada, alcance extralargo, métrico	190
5B	3 filos, punta esférica, longitud estándar, fraccional	191
5MB	3 filos, punta esférica, longitud estándar, métrico	192
5XLMB	3 filos, punta esférica, alcance extralargo, métrico	192
23	3 filos, cónico, punta cuadrada, longitud estándar, fraccional	193
24	3 filos, cónico, radio angulado, longitud estándar, fraccional	194
1	4 filos, punta cuadrada, longitud estándar, fraccional	195
1L	4 filos, punta cuadrada, largo alcance, fraccional	195
1EL	4 filos, punta cuadrada, longitud extendida, fraccional	195
1CR	4 filos, radio angulado, longitud estándar, fraccional	195
1M	4 filos, punta cuadrada, longitud estándar, métrico	199
1XLM	4 filos, punta cuadrada, alcance extralargo, métrico	199
1MCR	4 filos, radio angulado, longitud estándar, métrico	199
1B	4 filos, punta esférica, longitud estándar, fraccional	201
1LB	4 filos, punta esférica, largo alcance, fraccional	201
1ELB	4 filos, punta esférica, longitud extendida, fraccional	201
1MB	4 filos, punta esférica, longitud estándar, métrico	202
1XLMB	4 filos, punta esférica, alcance extralargo, métrico	202
14	4 filos, pieza doble de punta cuadrada, fraccional	203
14M	4 filos, pieza doble de punta cuadrada, métrico	203
14B	4 filos, pieza doble de punta esférica, fraccional	204
14MB	4 filos, pieza doble de punta esférica, métrico	204
16	4 filos, pieza de punta cuadrada, fraccional	205
16M	4 filos, pieza de punta cuadrada, métrico	205
54	4 filos, alto rendimiento, punta cuadrada, longitud estándar, fraccional	206
54M	4 filos, alto rendimiento, punta cuadrada, longitud estándar, métrico	206
61	Filo múltiple, paso grueso, desbastador, fraccional	207
61M	Filo múltiple, paso grueso, desbastador, métrico	207
62	Filo múltiple, paso fino, desbastador, fraccional	208
62M	Filo múltiple, paso fino, desbastador, métrico	209
Juegos de fresas	2, 3 y 4 filos, punta cuadrada, series 1, 3, 5, 14, 15	210
	2, 3 y 4 filos, punta esférica, series 1B, 3B, 5B, 14B, 15B	211

Recomendaciones de Velocidad y Avance mostrados al final de esta sección.

SÉRIES	DESCRIPTION DE FRAISES À USAGE GÉNÉRAL	PAGE
3	2 dents non rayonné longueur standard (fractionnel)	176
3L	2 dents non rayonné longue portée (fractionnel)	176
3EL	2 dents non rayonné extra-long (fractionnel)	176
3CR	2 dents rayonné longueur standard (fractionnel)	176
3M	2 dents non rayonné longueur standard (métrique)	179
3XLM	2 dents non rayonné portée extra-longue (métrique)	179
3B	2 dents à bout hémisphérique longueur standard (fractionnel)	180
3LB	2 dents à bout hémisphérique longue portée (fractionnel)	180
3ELB	2 dents à bout hémisphérique extra-long (fractionnel)	180
3MB	2 dents à bout hémisphérique longueur standard (métrique)	182
3XLMB	2 dents à bout hémisphérique portée extra-longue (métrique)	182
15	2 dents à double bouts plats court (fractionnel)	183
15M	2 dents à double bouts plats court (métrique)	183
15B	2 dents à double bouts hémisphériques court (fractionnel)	184
15MB	2 dents à double bouts hémisphériques court (métrique)	184
17	2 dents non rayonné court (fractionnel)	185
17M	2 dents non rayonné court (métrique)	185
52	2 dents cisaillement élevé non rayonné longueur standard (fractionnel)	186
52M	2 dents cisaillement élevé non rayonné longueur standard (métrique)	186
59	2 dents non rayonné longue portée (fractionnel)	187
59M	2 dents non rayonné longue portée (métrique)	187
59B	2 dents à bout hémisphérique longue portée (fractionnel)	188
59MB	2 dents à bout hémisphérique longue portée (métrique)	188
5	3 dents non rayonné longueur standard (fractionnel)	189
5M	3 dents non rayonné longueur standard (métrique)	190
5XLM	3 dents non rayonné portée extra-longue (métrique)	190
5B	3 dents à bout hémisphérique longueur standard (fractionnel)	191
5MB	3 dents à bout hémisphérique longueur standard (métrique)	192
5XLMB	3 dents à bout hémisphérique portée extra-longue (métrique)	192
23	3 dents conique non rayonné longueur standard (fractionnel)	193
24	3 dents conique rayonné longueur standard (fractionnel)	194
1	4 dents non rayonné longueur standard (fractionnel)	195
1L	4 dents non rayonné longue portée (fractionnel)	195
1EL	4 dents non rayonné extra-long (fractionnel)	195
1CR	4 dents rayonné longueur standard (fractionnel)	195
1M	4 dents non rayonné longueur standard (métrique)	199
1XLM	4 dents non rayonné portée extra-longue (métrique)	199
1MCR	4 dents rayonné longueur standard (métrique)	199
1B	4 dents à bout hémisphérique longueur standard (fractionnel)	201
1LB	4 dents à bout hémisphérique longue portée (fractionnel)	201

SÉRIES	DESCRIPTION DE FRAISES À USAGE GÉNÉRAL	PAGE
1ELB	4 dents à bout hémisphérique extra-long (fractionnel)	201
1MB	4 dents à bout hémisphérique longueur standard (métrique)	202
1XLMB	4 dents à bout hémisphérique portée extra-longue (métrique)	202
14	4 dents à double bouts plats court (fractionnel)	203
14M	4 dents à double bouts plats court (métrique)	203
14B	4 dents à double bouts hémisphériques court (fractionnel)	204
14MB	4 dents à double bouts hémisphériques court (métrique)	204
16	4 dents non rayonné court (fractionnel)	205
16M	4 dents non rayonné court (métrique)	205
54	4 dents cisaillement élevé non rayonné longueur standard (fractionnel)	206
54M	4 dents cisaillement élevé non rayonné longueur standard (métrique)	206
61	Multi-dents à pas gros d'ébauche (fractionnel)	207
61M	Multi-dents à pas gros d'ébauche (métrique)	207
62	Multi-dents à pas fin d'ébauche (fractionnel)	208
62M	Multi-dents à pas fin d'ébauche (métrique)	209
Jeux de fraises	2, 3, & 4 Série goujure non rayonné 1,3,5,14,15	210
	2, 3, & 4 Série goujure à bout hémisphérique 15B, 15MB, 15B, 15MB, 15B, 15MB	211

Les avances et les vitesses recommandées se trouvent à la fin du chapitre.

SERIE	BESCHREIBUNG DER STANDARD-SCHAFTFRÄSER	SEITE
3	Zölliger Schafffräser mit 2 Schneiden ohne Eckenradien, Standardlänge	176
3L	Zölliger Langloch-Schafffräser mit 2 Schneiden ohne Eckenradien	176
3EL	Zölliger Schafffräser mit 2 Schneiden ohne Eckenradien, extra lang	176
3CR	Zölliger Schafffräser mit 2 Schneiden mit Eckenradien, Standardlänge	176
3M	Schafffräser mit 2 Schneiden ohne Eckenradien, Standardlänge	179
3XLM	Langloch-Schafffräser mit 2 Schneiden ohne Eckenradien	179
3B	Zölliger Radiuschafffräser mit 2 Schneiden, Standardlänge	180
3LB	Zölliger Langloch-Radiuschafffräser mit 2 Schneiden	180
3ELB	Zölliger Schafffräser mit 2 Schneiden, Extra lang	180
3MB	Schafffräser mit 2 Schneiden, Standardlänge	182
3XLMB	Superlangloch-Schafffräser mit 2 Schneiden	182
15	Zölliger Schafffräser mit 2 Schneiden, kurze Ausführung	183
15M	Schafffräser mit 2 Schneiden, kurze Ausführung	183
15B	Zölliger Doppelend-Radiuschafffräser mit 2 Schneiden, kurze Ausführung	184
15MB	Doppelend-Radiuschafffräser mit 2 Schneiden, kurze Ausführung	184
17	Zölliger Schafffräser mit 2 Schneiden ohne Eckenradien, kurze Ausführung	185
17M	Schafffräser mit 2 Schneiden ohne Eckenradien, kurze Ausführung	185
52	Zölliger Schafffräser hoher Scherfestigkeit mit 2 Schneiden ohne Eckenradien, Standardlänge	186
52M	Schafffräser hoher Scherfestigkeit mit 2 Schneiden ohne Eckenradien, Standardlänge	186
59	Zölliger Langloch-Schafffräser mit 2 Schneiden ohne Eckenradien	187
59M	Langloch-Schafffräser mit 2 Schneiden ohne Eckenradien	187
59B	Zölliger Langloch-Radiuschafffräser mit 2 Schneiden	188
59MB	Langloch-Radiuschafffräser mit 2 Schneiden	188
5	Zölliger Schafffräser mit 3 Schneiden ohne Eckenradien, Standardlänge	189
5M	Schafffräser mit 3 Schneiden ohne Eckenradien, Standardlänge	190
5XLM	Langloch-Schafffräser mit 3 Schneiden ohne Eckenradien	190
5B	Zölliger Schafffräser mit 3 Schneiden, Standardlänge	191
5MB	Schafffräser mit 3 Schneiden, Standardlänge	192
5XLMB	Langloch-Schafffräser mit 3 Schneiden	192
23	Zölliger Schafffräser mit 3 Schneiden ohne Eckenradien, Standardlänge	193
24	Zölliger Schafffräser mit 3 Schneiden mit Eckenradien, Standardlänge	194
1	Zölliger Schafffräser mit 4 Schneiden ohne Eckenradien, Standardlänge	195
1L	Zölliger Langloch-Schafffräser mit 4 Schneiden ohne Eckenradien	195
1EL	Zölliger Schafffräser mit 4 Schneiden ohne Eckenradien, extra lang	195
1CR	Zölliger Schafffräser mit 4 Schneiden mit Eckenradien, Standardlänge	195
1M	Schafffräser mit 4 Schneiden ohne Eckenradien, Standardlänge	199
1XLM	Superlangloch-Schafffräser mit 4 Schneiden ohne Eckenradien	199
1MCR	Schafffräser mit 4 Schneiden mit Eckenradien, Standardlänge	199
1B	Zölliger Schafffräser mit 4 Schneiden, Standardlänge	201
1LB	Zölliger Langloch-Radiuschafffräser mit 4 Schneiden	201

SERIE	BESCHREIBUNG DER STANDARD-SCHAFTFRÄSER	SEITE
1ELB	Zölliger Schaftfräser mit 4 Schneiden, Extra lang	201
1MB	Schaftfräser mit 4 Schneiden, Standardlänge	202
1XLMB	Langloch-Radiuschaftfräser mit 4 Schneiden	202
14	Zölliger Schaftfräser mit 4 Schneiden, kurze Ausführung	203
14M	Schaftfräser mit 4 Schneiden, kurze Ausführung	203
14B	Zölliger Doppelend-Radiuschaftfräser mit 4 Schneiden, kurze Ausführung	204
14MB	Doppelend-Radiuschaftfräser mit 4 Schneiden, kurze Ausführung	204
16	Zölliger Schaftfräser mit 4 Schneiden ohne Eckenradien, kurze Ausführung	205
16M	Schaftfräser mit 4 Schneiden ohne Eckenradien, kurze Ausführung	205
54	Zölliger Schaftfräser hoher Scherfestigkeit mit 4 Schneiden ohne Eckenradien, Standardlänge	206
54M	Schaftfräser hoher Scherfestigkeit mit 4 Schneiden ohne Eckenradien, Standardlänge	206
61	Zölliger mehrschneidiger fein verzahnter Schruffräser	207
61M	Mehrschneidiger fein verzahnter Schruffräser	207
62	Zölliger mehrschneidiger fein verzahnter Schruffräser	208
62M	Mehrschneidiger fein verzahnter Schruffräser	209
Richtwerte zum Fräsen	Schaftfräser mit 2, 3 und 4 Schneiden ohne Eckenradien, Serien 1, 3, 5, 14, 15 Radiuschaftfräser mit 2, 3 und 4 Schneiden, Serien 1B, 3B, 5B, 14B ,15B	210 211

Schnittwertempfehlungen finden Sie am Ende dieses Abschnitts

2 Flute Square End • 2 Flute Corner Radius

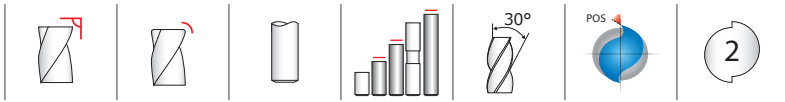

**3•3L•
3EL•3CR**
FRACTIONAL SERIES

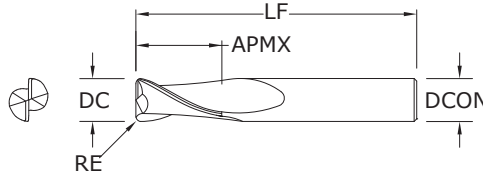

TOLERANCES (inch)

DC = -0.001/-0.002
DCON = h₆
RE = +0.0000/-0.0020

- STEELS
- STAINLESS STEELS
- CAST IRON
- HIGH TEMP ALLOYS
- TITANIUM
- HARDENED STEELS
- NON-FERROUS
- PLASTICS/COMPOSITES

For patent information visit www.ksptpatents.com

CUTTING DIAMETER DC	LENGTH OF CUT APMX	inch			EDP NO.					SERIES
		OVERALL LENGTH LF	SHANK DIAMETER DCON	CORNER RADIUS RE	UNCOATED	Ti-NAMITE (TiN)	Ti-NAMITE-C (TiCN)	Ti-NAMITE-A (AlTiN)	Di-NAMITE® (Diamond)	
1/64	1/32	1-1/2	1/8	—	30301	39301	39501	30397	—	3
1/32	5/64	1-1/2	1/8	—	30303	39303	39503	30398	—	3
3/64	7/64	1-1/2	1/8	—	30305	39305	39505	30399	—	3
1/16	3/16	1-1/2	1/8	—	30307	39307	39507	30400	91266	3
5/64	3/16	1-1/2	1/8	—	30309	39309	39509	30435	—	3
3/32	9/32	1-1/2	1/8	—	30311	39311	39511	30436	—	3
7/64	3/8	1-1/2	1/8	—	30313	39313	39513	30437	—	3
1/8	3/8	1-1/2	1/8	—	30377	39377	39577	30469	—	3
*1/8	1/2	1-1/2	1/8	—	30315	39315	39515	30438	91270	3
**1/8	1/2	1-1/2	1/8	.015	38201	38202	38315	38357	—	3CR
**1/8	1/2	1-1/2	1/8	.020	38203	38204	38316	38358	—	3CR
1/8	3/4	2-1/4	1/8	—	33341	31800	31810	31850	—	3L
1/8	1	3	1/8	—	33343	31938	31948	31958	—	3EL
9/64	1/2	2	3/16	—	30317	39317	39517	30439	—	3
5/32	1/2	2	3/16	—	30319	39319	39519	30440	—	3
11/64	5/8	2	3/16	—	30321	39321	39521	30441	—	3
*3/16	5/8	2	3/16	—	30323	39323	39523	30442	91274	3
**3/16	5/8	2	3/16	.015	38209	38210	38317	38359	—	3CR
**3/16	5/8	2	3/16	.020	38211	38212	38318	38360	—	3CR
**3/16	5/8	2	3/16	.030	38213	38214	38319	38361	—	3CR
3/16	3/4	2-1/2	3/16	—	33301	31820	31825	31851	—	3L
3/16	1-1/8	3	3/16	—	33321	31939	31949	31959	—	3EL
13/64	5/8	2-1/2	1/4	—	30325	39325	39525	30443	—	3
7/32	5/8	2-1/2	1/4	—	30327	39327	39527	30444	—	3
15/64	3/4	2-1/2	1/4	—	30329	39329	39529	30445	—	3
*1/4	3/4	2-1/2	1/4	—	30331	39331	39531	30446	91278	3
**1/4	3/4	2-1/2	1/4	.015	38219	38220	38320	38362	—	3CR
**1/4	3/4	2-1/2	1/4	.020	38221	38222	38321	38363	—	3CR
**1/4	3/4	2-1/2	1/4	.030	38223	38224	38322	38364	—	3CR
**1/4	3/4	2-1/2	1/4	.045	38225	38226	38323	38365	—	3CR
1/4	1-1/8	3	1/4	—	33303	31802	31812	31852	—	3L
1/4	1-1/2	4	1/4	—	33323	31940	31950	31960	—	3EL
17/64	3/4	2-1/2	5/16	—	30333	39333	39533	30447	—	3
9/32	3/4	2-1/2	5/16	—	30335	39335	39535	30448	—	3

continued on next page

2 Flute Square End • 2 Flute Corner Radius

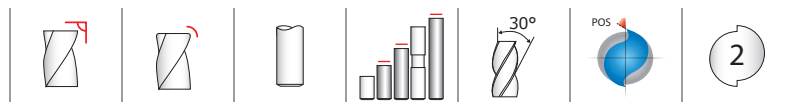

TOLERANCES (inch)
 DC = -0.001/-0.002
 DCON = h₆
 RE = +0.0000/-0.0020

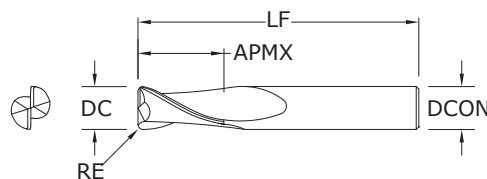

**3•3L•
3EL•3CR**
 FRACTIONAL SERIES

CUTTING DIAMETER DC	LENGTH OF CUT APMX	inch			CORNER RADIUS RE	EDP NO.					SERIES
		OVERALL LENGTH LF	SHANK DIAMETER DCON	UNCOATED		Ti-NAMITE (TiN)	Ti-NAMITE-C (TiCN)	Ti-NAMITE-A (AlTiN)	Di-NAMITE® (Diamond)		
19/64	13/16	2-1/2	5/16	-	30337	39337	39537	30449	-	3	
*5/16	13/16	2-1/2	5/16	-	30339	39339	39539	30450	91282	3	
**5/16	13/16	2-1/2	5/16	.015	38231	38232	38324	38366	-	3CR	
**5/16	13/16	2-1/2	5/16	.020	38233	38234	38325	38367	-	3CR	
**5/16	13/16	2-1/2	5/16	.030	38235	38236	38326	38368	-	3CR	
**5/16	13/16	2-1/2	5/16	.045	38237	38238	38327	38369	-	3CR	
5/16	1-1/8	3	5/16	-	33305	31821	31826	31853	-	3L	
5/16	1-5/8	4	5/16	-	33325	31941	31951	31961	-	3EL	
21/64	1	2-1/2	3/8	-	30341	39341	39541	30451	-	3	
11/32	1	2-1/2	3/8	-	30343	39343	39543	30452	-	3	
23/64	1	2-1/2	3/8	-	30345	39345	39545	30453	-	3	
*3/8	1	2-1/2	3/8	-	30347	39347	39547	30454	91286	3	
3/8	1	2-1/2	3/8	.015	38245	38246	38328	38370	-	3CR	
3/8	1	2-1/2	3/8	.020	38247	38248	38329	38371	-	3CR	
3/8	1	2-1/2	3/8	.030	38249	38250	38330	38372	-	3CR	
3/8	1	2-1/2	3/8	.045	38251	38252	38331	38373	-	3CR	
3/8	1-1/8	3	3/8	-	33307	31804	31814	31854	-	3L	
3/8	1-3/4	4	3/8	-	33327	31942	31952	31962	-	3EL	
25/64	1	2-3/4	7/16	-	30349	39349	39549	30455	-	3	
13/32	1	2-3/4	7/16	-	30351	39351	39551	30456	-	3	
27/64	1	2-3/4	7/16	-	30353	39353	39553	30457	-	3	
7/16	1	2-3/4	7/16	-	30355	39355	39555	30458	-	3	
7/16	2	4-1/2	7/16	-	33309	31822	31827	31855	-	3L	
7/16	3	6	7/16	-	33329	31943	31953	31963	-	3EL	
29/64	1	3	1/2	-	30357	39357	39557	30459	-	3	
15/32	1	3	1/2	-	30359	39359	39559	30460	-	3	
31/64	1	3	1/2	-	30361	39361	39561	30461	-	3	
*1/2	1	3	1/2	-	30363	39363	39563	30462	91290	3	
1/2	1	3	1/2	.015	38259	38260	38332	38374	-	3CR	
1/2	1	3	1/2	.020	38261	38262	38333	38375	-	3CR	
1/2	1	3	1/2	.030	38263	38264	38334	38376	-	3CR	
1/2	1	3	1/2	.045	38265	38266	38335	38377	-	3CR	
1/2	1	3	1/2	.060	38267	38268	38336	38378	-	3CR	
1/2	2	4-1/2	1/2	-	33311	31806	31816	31856	-	3L	

CONTINUED

- STEELS
- STAINLESS STEELS
- CAST IRON
- HIGH TEMP ALLOYS
- TITANIUM
- HARDENED STEELS
- NON-FERROUS
- PLASTICS/COMPOSITES

For patent information visit www.ksptpatents.com

continued on next page

2 Flute Square End • 2 Flute Corner Radius

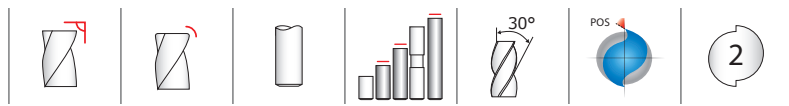

**3•3L•
3EL•3CR**
FRACTIONAL SERIES

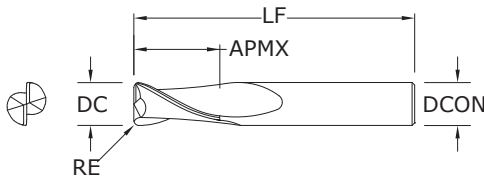

TOLERANCES (inch)

DC = -0.001/-0.002
DCON = h₆
RE = +0.0000/-0.0020

CONTINUED

- STEELS
- STAINLESS STEELS
- CAST IRON
- HIGH TEMP ALLOYS
- TITANIUM
- HARDENED STEELS
- NON-FERROUS
- PLASTICS/COMPOSITES

For patent information visit www.ksptpatents.com

CUTTING DIAMETER DC	LENGTH OF CUT APMX	inch			EDP NO.					SERIES
		OVERALL LENGTH LF	SHANK DIAMETER DCON	CORNER RADIUS RE	UNCOATED	Ti-NAMITE (TiN)	Ti-NAMITE-C (TiCN)	Ti-NAMITE-A (AlTiN)	Di-NAMITE® (Diamond)	
1/2	3	6	1/2	—	33331	31944	31954	31964	—	3EL
9/16	1-1/8	3-1/2	9/16	—	30365	39365	39565	30463	—	3
5/8	1-1/4	3-1/2	5/8	—	30367	39367	39567	30464	—	3
5/8	1-1/4	3-1/2	5/8	.015	38273	38274	38337	38379	—	3CR
5/8	1-1/4	3-1/2	5/8	.020	38275	38276	38338	38380	—	3CR
5/8	1-1/4	3-1/2	5/8	.030	38277	38278	38339	38381	—	3CR
5/8	1-1/4	3-1/2	5/8	.045	38279	38280	38340	38382	—	3CR
5/8	1-1/4	3-1/2	5/8	.060	38281	38282	38341	38383	—	3CR
5/8	1-1/4	3-1/2	5/8	.090	38283	38284	38342	38384	—	3CR
5/8	2-1/4	5	5/8	—	33313	31823	31817	31857	—	3L
5/8	3	6	5/8	—	33333	31945	31955	31965	—	3EL
11/16	1-3/8	4	3/4	—	30369	39369	39569	30465	—	3
3/4	1-1/2	4	3/4	—	30371	39371	39571	30466	—	3
3/4	1-1/2	4	3/4	.015	38287	38288	38343	38385	—	3CR
3/4	1-1/2	4	3/4	.020	38289	38290	38344	38386	—	3CR
3/4	1-1/2	4	3/4	.030	38291	38292	38345	38387	—	3CR
3/4	1-1/2	4	3/4	.045	38293	38294	38346	38388	—	3CR
3/4	1-1/2	4	3/4	.060	38295	38296	38347	38389	—	3CR
3/4	1-1/2	4	3/4	.090	38297	38298	38348	38390	—	3CR
3/4	1-1/2	4	3/4	.125	38299	38300	38349	38391	—	3L
3/4	3	6	3/4	—	33335	31946	31956	31966	—	3EL
7/8	1-1/2	4	7/8	—	30373	39373	39573	30467	—	3
1	1-1/2	4	1	—	30375	39375	39575	30468	—	3
1	1-1/2	4	1	.015	38301	38302	38350	38392	—	3CR
1	1-1/2	4	1	.020	38303	38304	38351	38393	—	3CR
1	1-1/2	4	1	.030	38305	38306	38352	38394	—	3CR
1	1-1/2	4	1	.045	38307	38308	38353	38395	—	3CR
1	1-1/2	4	1	.060	38309	38310	38354	38396	—	3CR
1	1-1/2	4	1	.090	38311	38312	38355	38397	—	3CR
1	1-1/2	4	1	.125	38313	38314	38356	38398	—	3CR
1	2-1/4	5	1	—	33317	31824	31819	31859	—	3L
1	3	6	1	—	33337	31947	31957	31967	—	3EL
*Series 3 Set				—	30389	39389	39589	30470	—	3

**Without Flat

2 Flute Square End

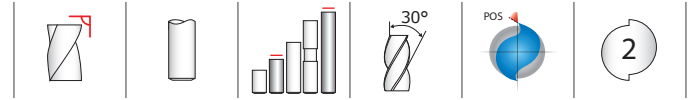

TOLERANCES (mm)

DC = +0,000/-0,050
 DCON = h₆

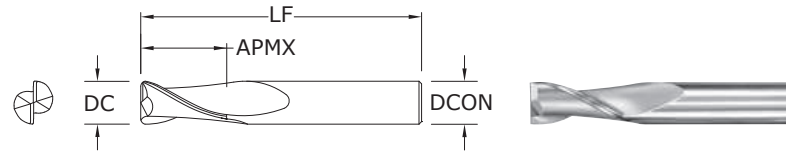

**3M·
3XLM**
METRIC SERIES

mm				EDP NO.				SERIES
CUTTING DIAMETER DC	LENGTH OF CUT APMX	OVERALL LENGTH LF	SHANK DIAMETER DCON	UNCOATED	Ti-NAMITE (TiN)	Ti-NAMITE-C (TiCN)	Ti-NAMITE-A (AlTiN)	
1,0	4,0	38,0	3,0	40305	48628	48650	48671	3M
1,5	4,5	38,0	3,0	40309	48629	48651	48672	3M
2,0	6,3	38,0	3,0	40313	48630	48652	48673	3M
2,5	9,5	38,0	3,0	40317	48631	48653	48674	3M
3,0	12,0	38,0	3,0	40321	48632	48654	48675	3M
3,0	25,0	75,0	3,0	43301	49427	49440	49453	3XLM
3,5	12,0	50,0	4,0	40325	48633	48655	48676	3M
4,0	14,0	50,0	4,0	40329	48634	48656	48677	3M
4,0	25,0	75,0	4,0	43303	49428	49441	49454	3XLM
4,5	16,0	50,0	6,0	40333	48635	48657	48678	3M
5,0	16,0	50,0	6,0	40337	48636	48658	48679	3M
5,0	25,0	75,0	5,0	43307	49430	49443	49456	3XLM
6,0	19,0	50,0	6,0	40341	48637	48659	48680	3M
6,0	25,0	75,0	6,0	43305	49429	49442	49455	3XLM
7,0	19,0	63,0	8,0	40345	48638	48660	48681	3M
8,0	20,0	63,0	8,0	40349	48639	48661	48682	3M
8,0	25,0	75,0	8,0	43315	49431	49444	49457	3XLM
9,0	22,0	75,0	10,0	40353	48640	48662	48683	3M
10,0	22,0	75,0	10,0	40357	48641	48663	48684	3M
10,0	38,0	100,0	10,0	43325	49432	49445	49458	3XLM
11,0	25,0	75,0	12,0	40361	48642	48664	48685	3M
12,0	25,0	75,0	12,0	40365	48643	48665	48686	3M
12,0	50,0	100,0	12,0	43335	49433	49446	49459	3XLM
12,0	75,0	150,0	12,0	43345	49434	49447	49460	3XLM
14,0	32,0	89,0	14,0	40369	48644	48666	48687	3M
14,0	75,0	150,0	14,0	43355	49435	49448	49461	3XLM
16,0	32,0	89,0	16,0	40373	48645	48667	48688	3M
16,0	75,0	150,0	16,0	43365	49436	49449	49462	3XLM
18,0	38,0	100,0	18,0	40377	48646	48668	48689	3M
18,0	75,0	150,0	18,0	43375	49437	49450	49463	3XLM
20,0	38,0	100,0	20,0	40381	48647	48669	48690	3M
20,0	75,0	150,0	20,0	43385	49438	49451	49464	3XLM
25,0	38,0	100,0	25,0	40385	48648	48670	48691	3M
25,0	75,0	150,0	25,0	43395	49439	49452	49465	3XLM

- STEELS
- STAINLESS STEELS
- CAST IRON
- HIGH TEMP ALLOYS
- TITANIUM
- HARDENED STEELS
- NON-FERROUS
- PLASTICS/COMPOSITES

For patent information visit www.ksptpatents.com

2 Flute Ball End

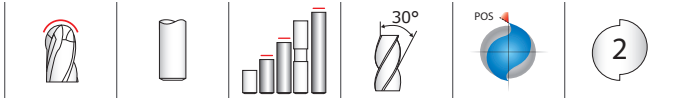

**3B•3LB•
3ELB**
FRACTIONAL SERIES

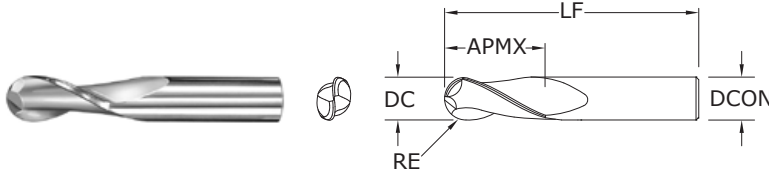

TOLERANCES (inch)

DC = -0.0000/-0.0020
DCON = h_6
RE = +0.0000/-0.0010

- STEELS
- STAINLESS STEELS
- CAST IRON
- HIGH TEMP ALLOYS
- TITANIUM
- HARDENED STEELS
- NON-FERROUS
- PLASTICS/COMPOSITES

For patent information visit www.ksptpatents.com

CUTTING DIAMETER DC	LENGTH OF CUT APMX	OVERALL LENGTH LF	SHANK DIAMETER DCON	EDP NO.				SERIES
				UNCOATED	Ti-NAMITE (TiN)	Ti-NAMITE-C (TiCN)	Ti-NAMITE-A (AlTiN)	
1/64	1/32	1-1/2	1/8	30302	39302	39502	30471	3B
1/32	5/64	1-1/2	1/8	30304	39304	39504	30472	3B
3/64	7/64	1-1/2	1/8	30306	39306	39506	30473	3B
1/16	3/16	1-1/2	1/8	30308	39308	39508	30474	3B
5/64	3/16	1-1/2	1/8	30310	39310	39510	30475	3B
3/32	9/32	1-1/2	1/8	30312	39312	39512	30476	3B
7/64	3/8	1-1/2	1/8	30314	39314	39514	30477	3B
1/8	3/8	1-1/2	1/8	30378	39378	39578	30599	3B
*1/8	1/2	1-1/2	1/8	30316	39316	39516	30478	3B
1/8	3/4	2-1/4	1/8	33342	31830	31840	31890	3LB
1/8	1	3	1/8	33344	31968	31978	31988	3ELB
9/64	1/2	2	3/16	30318	39318	39518	30479	3B
5/32	1/2	2	3/16	30320	39320	39520	30480	3B
11/64	5/8	2	3/16	30322	39322	39522	30481	3B
*3/16	5/8	2	3/16	30324	39324	39524	30482	3B
3/16	3/4	2-1/2	3/16	33302	31831	31841	31891	3LB
3/16	1-1/8	3	3/16	33322	31969	31979	31989	3ELB
13/64	5/8	2-1/2	1/4	30326	39326	39526	30483	3B
7/32	5/8	2-1/2	1/4	30328	39328	39528	30484	3B
15/64	3/4	2-1/2	1/4	30330	39330	39530	30485	3B
*1/4	3/4	2-1/2	1/4	30332	39332	39532	30486	3B
1/4	1-1/8	3	1/4	33304	31832	31842	31892	3LB
1/4	1-1/2	4	1/4	33324	31970	31980	31990	3ELB
17/64	3/4	2-1/2	5/16	30334	39334	39534	30487	3B
9/32	3/4	2-1/2	5/16	30336	39336	39536	30488	3B
19/64	13/16	2-1/2	5/16	30338	39338	39538	30489	3B
*5/16	13/16	2-1/2	5/16	30340	39340	39540	30490	3B
5/16	1-1/8	3	5/16	33306	31833	31843	31893	3LB
5/16	1-5/8	4	5/16	33326	31971	31981	31991	3ELB
21/64	1	2-1/2	3/8	30342	39342	39542	30491	3B

continued on next page

FRACTIONAL 2 Flute Ball End

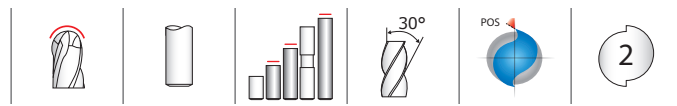

TOLERANCES (inch)

DC = -0.0000/-0.0020

DCON = h_6

RE = +0.0000/-0.0010

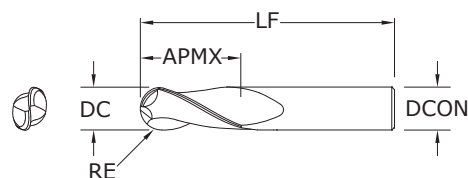

**3B•3LB•
3ELB**
FRACTIONAL SERIES

inch				EDP NO.				SERIES
CUTTING DIAMETER DC	LENGTH OF CUT APMX	OVERALL LENGTH LF	SHANK DIAMETER DCON	UNCOATED	Ti-NAMITE (TiN)	Ti-NAMITE-C (TiCN)	Ti-NAMITE-A (AlTiN)	
11/32	1	2-1/2	3/8	30344	39344	39544	30492	3B
23/64	1	2-1/2	3/8	30346	39346	39546	30493	3B
*3/8	1	2-1/2	3/8	30348	39348	39548	30494	3B
3/8	1-1/8	3	3/8	33308	31834	31844	31894	3LB
3/8	1-3/4	4	3/8	33328	31972	31982	31992	3ELB
25/64	1	2-3/4	7/16	30350	39350	39550	30495	3B
13/32	1	2-3/4	7/16	30352	39352	39552	30496	3B
27/64	1	2-3/4	7/16	30354	39354	39554	30497	3B
7/16	1	2-3/4	7/16	30356	39356	39556	30498	3B
7/16	2	4-1/2	7/16	33310	31835	31845	31895	3LB
7/16	3	6	7/16	33330	31973	31983	31993	3ELB
29/64	1	3	1/2	30358	39358	39558	30499	3B
15/32	1	3	1/2	30360	39360	39560	30500	3B
31/64	1	3	1/2	30362	39362	39562	30591	3B
*1/2	1	3	1/2	30364	39364	39564	30592	3B
1/2	2	4-1/2	1/2	33312	31836	31846	31896	3LB
1/2	3	6	1/2	33332	31974	31984	31994	3ELB
9/16	1-1/8	3-1/2	9/16	30366	39366	39566	30593	3B
5/8	1-1/4	3-1/2	5/8	30368	39368	39568	30594	3B
5/8	2-1/4	5	5/8	33314	31837	31847	31897	3LB
5/8	3	6	5/8	33334	31975	31985	31995	3ELB
11/16	1-3/8	4	3/4	30370	39370	39570	30595	3B
3/4	1-1/2	4	3/4	30372	39372	39572	30596	3B
3/4	2-1/4	5	3/4	33316	31838	31848	31898	3LB
3/4	3	6	3/4	33336	31976	31986	31996	3ELB
7/8	1-1/2	4	7/8	30374	39374	39574	30597	3B
1	1-1/2	4	1	30376	39376	39576	30598	3B
1	2-1/4	5	1	33318	31839	31849	31899	3LB
1	3	6	1	33338	31977	31987	31997	3ELB
*Series 3B Set				30390	39390	39590	30600	3B

RE = 1/2 Cutting Diameter (DC)

CONTINUED

- STEELS
- STAINLESS STEELS
- CAST IRON
- HIGH TEMP ALLOYS
- TITANIUM
- HARDENED STEELS
- NON-FERROUS
- PLASTICS/COMPOSITES

For patent information visit www.ksptpatents.com

2 Flute Ball End

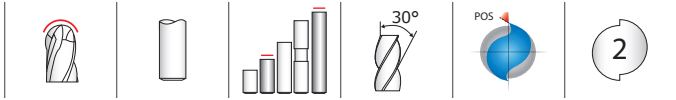

**3MB·
3XLMB**
METRIC SERIES

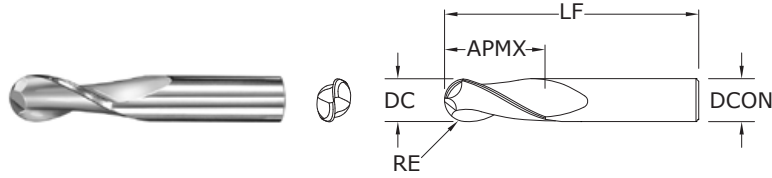

TOLERANCES (mm)

DC = +0,000/-0,050
 DCON = h₆
 RE = +0,000/-0,025

- STEELS
- STAINLESS STEELS
- CAST IRON
- HIGH TEMP ALLOYS
- TITANIUM
- HARDENED STEELS
- NON-FERROUS
- PLASTICS/COMPOSITES

For patent information visit www.ksptpatents.com

CUTTING DIAMETER DC	mm			EDP NO.				SERIES
	LENGTH OF CUT APMX	OVERALL LENGTH LF	SHANK DIAMETER DCON	UNCOATED	Ti-NAMITE (TiN)	Ti-NAMITE-C (TiCN)	Ti-NAMITE-A (AlTiN)	
1,0	4,0	38,0	3,0	40306	48692	48714	48735	3MB
1,5	4,5	38,0	3,0	40310	48693	48715	48736	3MB
2,0	6,3	38,0	3,0	40314	48694	48716	48737	3MB
2,5	9,5	38,0	3,0	40318	48695	48717	48738	3MB
3,0	12,0	38,0	3,0	40322	48696	48718	48739	3MB
3,0	25,0	75,0	3,0	43302	49544	49557	49570	3XLMB
3,5	12,0	50,0	4,0	40326	48697	48719	48740	3MB
4,0	14,0	50,0	4,0	40330	48698	48720	48741	3MB
4,0	25,0	75,0	4,0	43304	49545	49558	49571	3XLMB
4,5	16,0	50,0	6,0	40334	48699	48721	48742	3MB
5,0	16,0	50,0	6,0	40338	48700	48722	48743	3MB
5,0	25,0	75,0	5,0	43308	49547	49560	49573	3XLMB
6,0	19,0	50,0	6,0	40342	48701	48723	48744	3MB
6,0	25,0	75,0	6,0	43306	49546	49559	49572	3XLMB
7,0	19,0	63,0	8,0	40346	48702	48724	48745	3MB
8,0	20,0	63,0	8,0	40350	48703	48725	48746	3MB
8,0	25,0	75,0	8,0	43316	49548	49561	49574	3XLMB
9,0	22,0	75,0	10,0	40354	48704	48726	48747	3MB
10,0	22,0	75,0	10,0	40358	48705	48727	48748	3MB
10,0	38,0	100,0	10,0	43326	49549	49562	49575	3XLMB
11,0	25,0	75,0	12,0	40362	48706	48728	48749	3MB
12,0	25,0	75,0	12,0	40366	48707	48729	48750	3MB
12,0	50,0	100,0	12,0	43336	49550	49563	49576	3XLMB
12,0	75,0	150,0	12,0	43346	49551	49564	49577	3XLMB
14,0	32,0	89,0	14,0	40370	48708	48730	48751	3MB
14,0	75,0	150,0	14,0	43356	49552	49565	49578	3XLMB
16,0	32,0	89,0	16,0	40374	48709	48731	48752	3MB
16,0	75,0	150,0	16,0	43366	49553	49566	49579	3XLMB
18,0	38,0	100,0	18,0	40378	48710	48732	48753	3MB
18,0	75,0	150,0	18,0	43376	49554	49567	49580	3XLMB
20,0	38,0	100,0	20,0	40382	48711	48733	48754	3MB
20,0	75,0	150,0	20,0	43386	49555	49568	49581	3XLMB
25,0	38,0	100,0	25,0	40386	48712	48734	48755	3MB
25,0	75,0	150,0	25,0	43396	49556	49569	49582	3XLMB

RE = 1/2 Cutting Diameter (DC)

FRACTIONAL & METRIC 2 Flute Double End

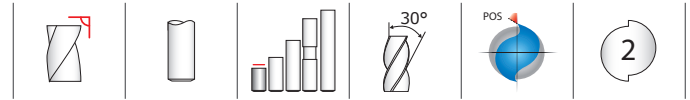

TOLERANCES (inch)

DC = +0.0000/-0.0020
DCON = h₆

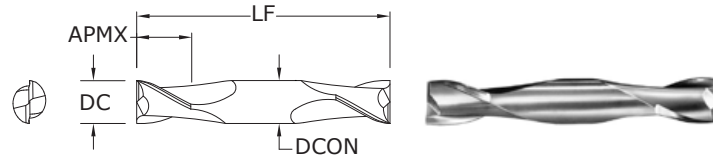

15
FRACTIONAL SERIES

inch				EDP NO.			
CUTTING DIAMETER DC	LENGTH OF CUT APMX	OVERALL LENGTH LF	SHANK DIAMETER DCON	UNCOATED	Ti-NAMITE (TiN)	Ti-NAMITE-C (TiCN)	Ti-NAMITE-A (AlTiN)
1/32	1/16	1-1/2	1/8	31501	31541	39651	31316
3/64	3/32	1-1/2	1/8	31503	31543	39653	31317
1/16	1/8	1-1/2	1/8	31505	31545	39655	31318
5/64	1/8	1-1/2	1/8	31507	31547	39657	31319
3/32	3/16	1-1/2	1/8	31509	31549	39659	31320
7/64	3/16	1-1/2	1/8	31511	31551	39661	31321
*1/8	1/4	1-1/2	1/8	31513	31553	39663	31322
9/64	5/16	2	3/16	31515	31555	39665	31323
5/32	5/16	2	3/16	31517	31557	39667	31324
11/64	5/16	2	3/16	31519	31559	39669	31325
*3/16	3/8	2	3/16	31521	31561	39671	31326
13/64	1/2	2-1/2	1/4	31523	31563	39673	31327
7/32	1/2	2-1/2	1/4	31525	31565	39675	31328
15/64	1/2	2-1/2	1/4	31527	31567	39677	31329
*1/4	1/2	2-1/2	1/4	31529	31569	39679	31330
9/32	1/2	2-1/2	5/16	31531	31571	39681	31331
*5/16	1/2	2-1/2	5/16	31533	31573	39683	31332
*3/8	9/16	2-1/2	3/8	31535	31575	39685	31333
7/16	9/16	2-3/4	7/16	31537	31577	39687	31334
*1/2	5/8	3	1/2	31539	31579	39689	31335
*Series 15 Set				31589	31581	39691	31336

- STEELS
- STAINLESS STEELS
- CAST IRON
- HIGH TEMP ALLOYS
- TITANIUM
- HARDENED STEELS
- NON-FERROUS
- PLASTICS/COMPOSITES

For patent information visit www.ksptpatents.com

TOLERANCES (mm)

DC = +0,000/-0,050
DCON = h₆

mm				EDP NO.			
CUTTING DIAMETER DC	LENGTH OF CUT APMX	OVERALL LENGTH LF	SHANK DIAMETER DCON	UNCOATED	Ti-NAMITE (TiN)	Ti-NAMITE-C (TiCN)	Ti-NAMITE-A (AlTiN)
1,0	2,0	38,0	3,0	41505	49010	49031	49052
1,5	3,0	38,0	3,0	41509	49011	49032	49053
2,0	4,0	38,0	3,0	41513	49012	49033	49054
2,5	5,0	38,0	3,0	41517	49013	49034	49055
3,0	6,0	38,0	3,0	41521	49014	49035	49056
3,5	7,0	50,0	4,0	41525	49015	49036	49057
4,0	8,0	50,0	4,0	41529	49016	49037	49058
4,5	9,5	63,0	4,5	41533	49017	49038	49059
5,0	10,0	63,0	5,0	41537	49018	49039	49060
6,0	12,0	63,0	6,0	41541	49019	49040	49061
7,0	12,0	63,0	8,0	41545	49020	49041	49062
8,0	12,0	63,0	8,0	41549	49021	49042	49063
9,0	14,0	75,0	9,0	41553	49022	49043	49064
10,0	14,0	75,0	10,0	41557	49023	49044	49065
11,0	14,0	75,0	12,0	41561	49024	49045	49066
12,0	16,0	75,0	12,0	41565	49025	49046	49067

- STEELS
- STAINLESS STEELS
- CAST IRON
- HIGH TEMP ALLOYS
- TITANIUM
- HARDENED STEELS
- NON-FERROUS
- PLASTICS/COMPOSITES

For patent information visit www.ksptpatents.com

15M
METRIC SERIES

2 Flute Double End Ball End

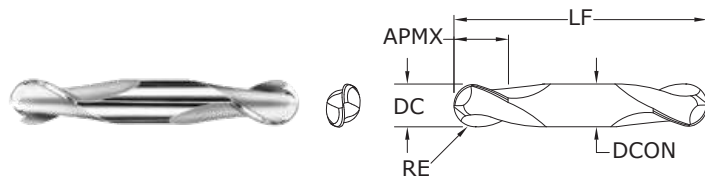
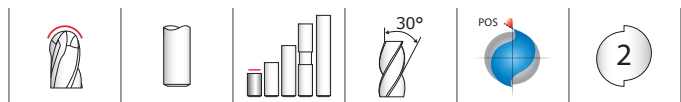

TOLERANCES (inch)

DC = -0.0000/-0.0020
 DCON = h₆
 RE = +0.0000/-0.0010

15B

FRACTIONAL SERIES

- STEELS
- STAINLESS STEELS
- CAST IRON
- HIGH TEMP ALLOYS
- TITANIUM
- HARDENED STEELS
- NON-FERROUS
- PLASTICS/COMPOSITES

For patent information visit www.ksptpatents.com

inch				EDP NO.			
CUTTING DIAMETER DC	LENGTH OF CUT APMX	OVERALL LENGTH LF	SHANK DIAMETER DCON	UNCOATED	Ti-NAMITE (TiN)	Ti-NAMITE-C (TiCN)	Ti-NAMITE-A (AITiN)
1/32	1/16	1-1/2	1/8	31502	31542	39652	31337
3/64	3/32	1-1/2	1/8	31504	31544	39654	31338
1/16	1/8	1-1/2	1/8	31506	31546	39656	31339
5/64	1/8	1-1/2	1/8	31508	31548	39658	31340
3/32	3/16	1-1/2	1/8	31510	31550	39660	31341
7/64	3/16	1-1/2	1/8	31512	31552	39662	31342
*1/8	1/4	1-1/2	1/8	31514	31554	39664	31343
9/64	5/16	2	3/16	31516	31556	39666	31344
5/32	5/16	2	3/16	31518	31558	39668	31345
11/64	5/16	2	3/16	31520	31560	39670	31346
*3/16	3/8	2	3/16	31522	31562	39672	31347
13/64	1/2	2-1/2	1/4	31524	31564	39674	31348
7/32	1/2	2-1/2	1/4	31526	31566	39676	31349
15/64	1/2	2-1/2	1/4	31528	31568	39678	31350
*1/4	1/2	2-1/2	1/4	31530	31570	39680	31351
9/32	1/2	2-1/2	5/16	31532	31572	39682	31352
*5/16	1/2	2-1/2	5/16	31534	31574	39684	31353
*3/8	9/16	2-1/2	3/8	31536	31576	39686	31354
7/16	9/16	2-3/4	7/16	31538	31578	39688	31355
*1/2	5/8	3	1/2	31540	31580	39690	31356
				31590	31582	39692	31357

*Series 15B Set
 RE = 1/2 Cutting Diameter (DC)

TOLERANCES (mm)

DC = +0,000/-0,050
 DCON = h₆
 RE = +0,000/0,025

15MB

METRIC SERIES

- STEELS
- STAINLESS STEELS
- CAST IRON
- HIGH TEMP ALLOYS
- TITANIUM
- HARDENED STEELS
- NON-FERROUS
- PLASTICS/COMPOSITES

For patent information visit www.ksptpatents.com

mm				EDP NO.			
CUTTING DIAMETER DC	LENGTH OF CUT APMX	OVERALL LENGTH LF	SHANK DIAMETER DCON	UNCOATED	Ti-NAMITE (TiN)	Ti-NAMITE-C (TiCN)	Ti-NAMITE-A (AITiN)
1,0	2,0	38,0	3,0	41506	49073	49094	49115
1,5	3,0	38,0	3,0	41510	49074	49095	49116
2,0	4,0	38,0	3,0	41514	49075	49096	49117
2,5	5,0	38,0	3,0	41518	49076	49097	49118
3,0	6,0	38,0	3,0	41522	49077	49098	49119
3,5	7,0	50,0	4,0	41526	49078	49099	49120
4,0	8,0	50,0	4,0	41530	49079	49100	49121
4,5	9,5	63,0	4,5	41534	49080	49101	49122
5,0	10,0	63,0	5,0	41538	49081	49102	49123
6,0	12,0	63,0	6,0	41542	49082	49103	49124
7,0	12,0	63,0	8,0	41546	49083	49104	49125
8,0	12,0	63,0	8,0	41550	49084	49105	49126
9,0	14,0	75,0	9,0	41554	49085	49106	49127
10,0	14,0	75,0	10,0	41558	49086	49107	49128
11,0	14,0	75,0	12,0	41562	49087	49108	49129
12,0	16,0	75,0	12,0	41566	49088	49109	49130

RE = 1/2 Cutting Diameter (DC)

2 Flute Square End Stub



TOLERANCES (inch)

DC = +0.0000/-0.0020

DCON = h₆

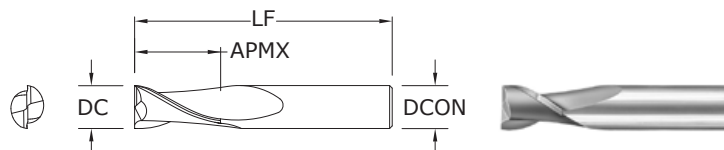

17
FRACTIONAL SERIES

inch				EDP NO.			
CUTTING DIAMETER DC	LENGTH OF CUT APMX	OVERALL LENGTH LF	SHANK DIAMETER DCON	UNCOATED	Ti-NAMITE (TiN)	Ti-NAMITE-C (TiCN)	Ti-NAMITE-A (AlTiN)
1/16	1/8	1-1/2	1/8	31701	31750	31303	31358
3/32	3/16	1-1/2	1/8	31703	31751	31304	31359
1/8	1/4	1-1/2	1/8	31705	31752	31305	31360
5/32	5/16	2	3/16	31707	31753	31306	31361
3/16	3/8	2	3/16	31709	31754	31307	31362
7/32	7/16	2	1/4	31711	31755	31308	31363
1/4	1/2	2	1/4	31713	31756	31309	31364
5/16	1/2	2	5/16	31715	31757	31310	31365
3/8	5/8	2	3/8	31717	31758	31311	31366
7/16	5/8	2-1/2	7/16	31719	31759	31312	31367
1/2	5/8	2-1/2	1/2	31721	31760	31313	31368
5/8	3/4	3	5/8	31723	31761	31314	31369
3/4	1	3	3/4	31725	31762	31315	31370

- STEELS
- STAINLESS STEELS
- CAST IRON
- HIGH TEMP ALLOYS
- TITANIUM
- HARDENED STEELS
- NON-FERROUS
- PLASTICS/COMPOSITES

For patent information visit www.ksptpatents.com

TOLERANCES (mm)

DC = +0,000/-0,050

DCON = h₆

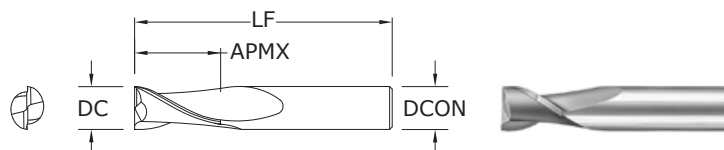

17M
METRIC SERIES

mm				EDP NO.			
CUTTING DIAMETER DC	LENGTH OF CUT APMX	OVERALL LENGTH LF	SHANK DIAMETER DCON	UNCOATED	Ti-NAMITE (TiN)	Ti-NAMITE-C (TiCN)	Ti-NAMITE-A (AlTiN)
1,0	2,0	38,0	3,0	41705	49262	49283	49304
1,5	3,0	38,0	3,0	41709	49263	49284	49305
2,0	4,0	38,0	3,0	41713	49264	49285	49306
2,5	5,0	38,0	3,0	41717	49265	49286	49307
3,0	6,0	38,0	3,0	41721	49266	49287	49308
3,5	7,0	50,0	4,0	41725	49267	49288	49309
4,0	8,0	50,0	4,0	41729	49268	49289	49310
4,5	9,5	50,0	4,5	41733	49269	49290	49311
5,0	10,0	50,0	5,0	41737	49270	49291	49312
6,0	12,0	50,0	6,0	41741	49271	49292	49313
7,0	12,0	50,0	8,0	41745	49272	49293	49314
8,0	12,0	50,0	8,0	41749	49273	49294	49315
9,0	14,0	50,0	9,0	41753	49274	49295	49316
10,0	16,0	50,0	10,0	41757	49275	49296	49317
11,0	19,0	63,0	12,0	41761	49276	49297	49318
12,0	19,0	63,0	12,0	41765	49277	49298	49319

- STEELS
- STAINLESS STEELS
- CAST IRON
- HIGH TEMP ALLOYS
- TITANIUM
- HARDENED STEELS
- NON-FERROUS
- PLASTICS/COMPOSITES

For patent information visit www.ksptpatents.com

2 Flute High Shear

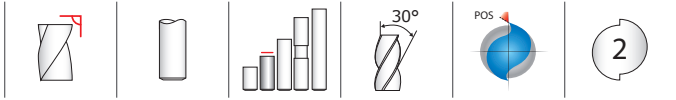

52 FRACTIONAL SERIES

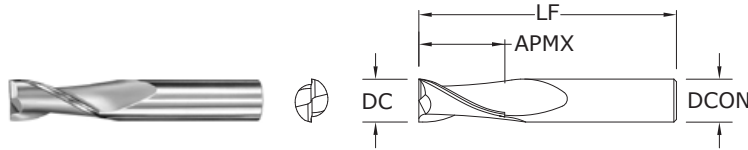

TOLERANCES (inch)
 DC = +0.0000/-0.0020
 DCON = h₆

CUTTING DIAMETER DC	LENGTH OF CUT APMX	OVERALL LENGTH LF	SHANK DIAMETER DCON	EDP NO.	
				UNCOATED	Ti-NAMITE-C (TiCN)
1/16	3/16	1-1/2	1/8	35273	35300
3/32	3/8	1-1/2	1/8	35275	35301
1/8	7/16	1-1/2	1/8	35277	35302
5/32	9/16	2	3/16	35278	35303
3/16	9/16	2	3/16	35279	35304
7/32	5/8	2-1/2	1/4	35280	35305
1/4	3/4	2-1/2	1/4	35281	35306
9/32	3/4	2-1/2	5/16	35282	35307
5/16	13/16	2-1/2	5/16	35283	35308
3/8	7/8	2-1/2	3/8	35285	35309
7/16	1	2-3/4	7/16	35287	35310
1/2	1	3	1/2	35289	35311
9/16	1-1/8	3-1/2	9/16	35291	35312
5/8	1-1/4	3-1/2	5/8	35293	35313
3/4	1-1/2	4	3/4	35295	35314
1	1-1/2	4	1	35297	35315

NON-FERROUS

PLASTICS/COMPOSITES

For patent information visit www.ksptpatents.com

52M METRIC SERIES

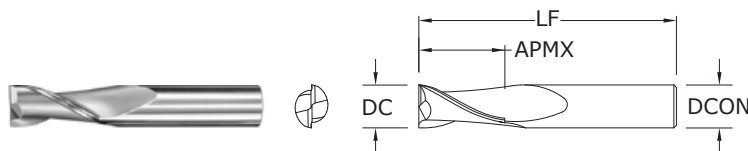

TOLERANCES (mm)
 DC = +0,000/-0,050
 DCON = h₆

CUTTING DIAMETER DC	LENGTH OF CUT APMX	OVERALL LENGTH LF	SHANK DIAMETER DCON	EDP NO.	
				UNCOATED	Ti-NAMITE-C (TiCN)
3,0	7,0	38,0	3,0	45277	49829
3,5	7,0	57,0	6,0	45279	49830
4,0	8,0	57,0	6,0	45281	49831
4,5	8,0	57,0	6,0	45283	49832
5,0	10,0	57,0	6,0	45285	49833
6,0	10,0	57,0	6,0	45287	49834
8,0	16,0	63,0	8,0	45289	49835
10,0	19,0	72,0	10,0	45291	49836
12,0	22,0	83,0	12,0	45293	49837
14,0	22,0	83,0	14,0	45295	49838
16,0	26,0	92,0	16,0	45297	49839
20,0	32,0	104,0	20,0	45299	49840

NON-FERROUS

PLASTICS/COMPOSITES

For patent information visit www.ksptpatents.com

2 Flute Square End Long Reach

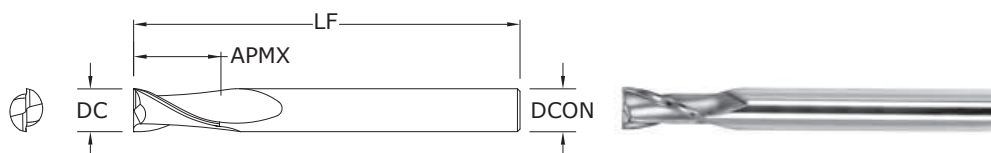
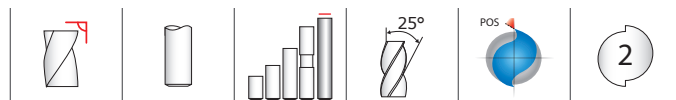

TOLERANCES (mm)

DC = +0,000/-0,050
DCON = h₆

59

FRACTIONAL SERIES

inch				EDP NO.		
CUTTING DIAMETER DC	LENGTH OF CUT APMX	OVERALL LENGTH LF	SHANK DIAMETER DCON	Ti-NAMITE (TiN)	Ti-NAMITE-C (TiCN)	Ti-NAMITE-A (AlTiN)
1/8	3/8	2-1/2	1/4	32280	32260	32270
3/16	9/16	3	1/4	32281	32261	32271
1/4	5/8	3-1/2	1/4	32282	32262	32272
5/16	11/16	4	5/16	32283	32263	32273
3/8	7/8	4	3/8	32284	32264	32274
1/2	1	4-1/2	1/2	32285	32265	32275
5/8	1-1/8	5	5/8	32286	32266	32276
3/4	1-3/8	5-1/4	3/4	32287	32267	32277

- STEELS
- STAINLESS STEELS
- CAST IRON
- HIGH TEMP ALLOYS
- TITANIUM
- HARDENED STEELS
- NON-FERROUS
- PLASTICS/COMPOSITES

Neck Option Available

For patent information visit www.ksptpatents.com

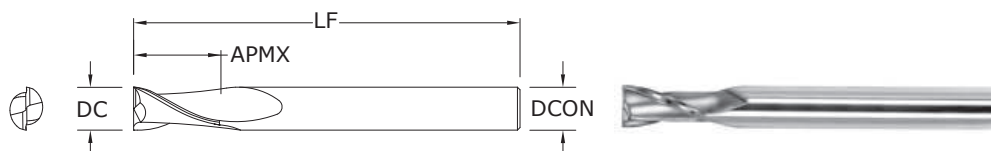

TOLERANCES (mm)

DC = +0,000/-0,050
DCON = h₆

59M

METRIC SERIES

mm				EDP NO.			
CUTTING DIAMETER DC	LENGTH OF CUT APMX	OVERALL LENGTH LF	SHANK DIAMETER DCON	UNCOATED	Ti-NAMITE (TiN)	Ti-NAMITE-C (TiCN)	Ti-NAMITE-A (AlTiN)
3,0	9,0	60,0	6,0	43910	43920	43930	43950
4,0	12,0	70,0	6,0	43911	43921	43931	43951
6,0	15,0	80,0	6,0	43912	43922	43932	43952
8,0	20,0	89,0	8,0	43913	43923	43933	43953
10,0	25,0	100,0	10,0	43914	43924	43934	43954
12,0	30,0	110,0	12,0	43915	43925	43935	43955
14,0	35,0	120,0	16,0	43916	43926	43936	43956
16,0	40,0	120,0	16,0	43917	43927	43937	43957
18,0	40,0	130,0	20,0	43918	43928	43938	43958
20,0	45,0	130,0	20,0	43919	43929	43939	43959

- STEELS
- STAINLESS STEELS
- CAST IRON
- HIGH TEMP ALLOYS
- TITANIUM
- HARDENED STEELS
- NON-FERROUS
- PLASTICS/COMPOSITES

Neck Option Available

For patent information visit www.ksptpatents.com

2 Flute Ball End Long Reach

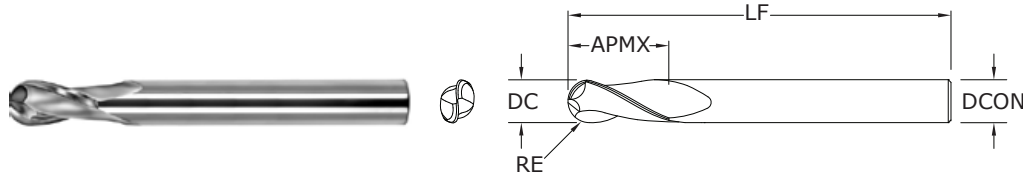
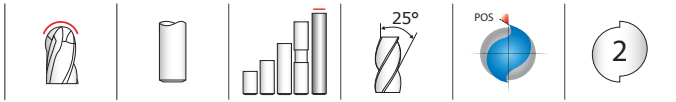

TOLERANCES (inch)

DC = -0.0000/-0.0020
 DCON = h_6
 RE = +0.0000/-0.0010

59B

FRACTIONAL SERIES

- STEELS
- STAINLESS STEELS
- CAST IRON
- HIGH TEMP ALLOYS
- TITANIUM
- HARDENED STEELS
- NON-FERROUS
- PLASTICS/COMPOSITES

inch				EDP NO.		
CUTTING DIAMETER DC	LENGTH OF CUT APMX	OVERALL LENGTH LF	SHANK DIAMETER DCON	Ti-NAMITE (TiN)	Ti-NAMITE-C (TiCN)	Ti-NAMITE-A (AlTiN)
1/8	3/8	2-1/2	1/4	32210	32290	32200
3/16	9/16	3	1/4	32211	32291	32201
1/4	5/8	3-1/2	1/4	32212	32292	32202
5/16	11/16	4	5/16	32213	32293	32203
3/8	7/8	4	3/8	32214	32294	32204
1/2	1	4-1/2	1/2	32215	32295	32205
5/8	1-1/8	5	5/8	32216	32296	32206
3/4	1-3/8	5-1/4	3/4	32217	32297	32207

Neck Option Available
 RE = 1/2 Cutting Diameter (DC)

For patent information visit www.ksptpatents.com

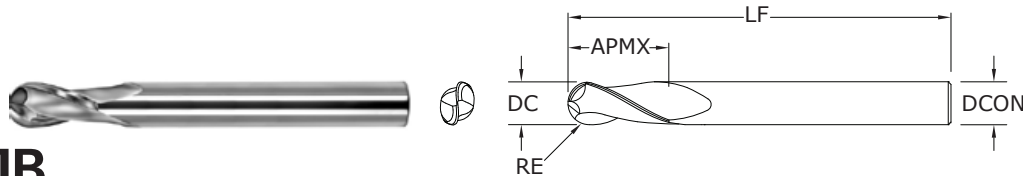

TOLERANCES (mm)

DC = +0,000/-0,050
 DCON = h_6
 RE = +0,000/-0,025

59MB

METRIC SERIES

- STEELS
- STAINLESS STEELS
- CAST IRON
- HIGH TEMP ALLOYS
- TITANIUM
- HARDENED STEELS
- NON-FERROUS
- PLASTICS/COMPOSITES

mm				EDP NO.			
CUTTING DIAMETER DC	LENGTH OF CUT APMX	OVERALL LENGTH LF	SHANK DIAMETER DCON	UNCOATED	Ti-NAMITE (TiN)	Ti-NAMITE-C (TiCN)	Ti-NAMITE-A (AlTiN)
3,0	9,0	60,0	6,0	43900	49622	49632	49642
4,0	12,0	70,0	6,0	43901	49623	49633	49643
6,0	15,0	80,0	6,0	43902	49624	49634	49644
8,0	20,0	89,0	8,0	43903	49625	49635	49645
10,0	25,0	100,0	10,0	43904	49626	49636	49646
12,0	30,0	110,0	12,0	43905	49627	49637	49647
14,0	35,0	120,0	16,0	43906	49628	49638	49648
16,0	40,0	120,0	16,0	43907	49629	49639	49649
18,0	40,0	130,0	20,0	43908	49630	49640	49650
20,0	45,0	130,0	20,0	43909	49631	49641	49651

Neck Option Available
 RE = 1/2 Cutting Diameter (DC)

For patent information visit www.ksptpatents.com

3 Flute Square End

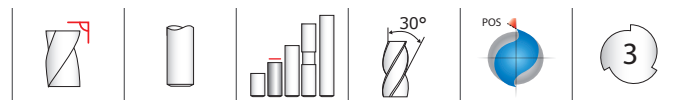

TOLERANCES (inch)

DC = -0.0000/-0.0020
 DCON = h₆

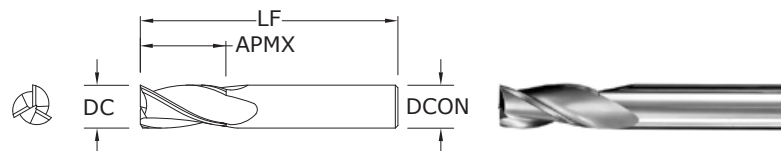

5
 FRACTIONAL SERIES

inch				EDP NO.			
CUTTING DIAMETER DC	LENGTH OF CUT APMX	OVERALL LENGTH LF	SHANK DIAMETER DCON	UNCOATED	Ti-NAMITE (TiN)	Ti-NAMITE-C (TiCN)	Ti-NAMITE-A (AlTiN)
1/64	1/32	1-1/2	1/8	30501	39701	30771	30811
1/32	5/64	1-1/2	1/8	30503	39703	30772	30812
3/64	7/64	1-1/2	1/8	30505	39705	30773	30813
1/16	3/16	1-1/2	1/8	30507	39707	30774	30814
5/64	3/16	1-1/2	1/8	30509	39709	30775	30815
3/32	9/32	1-1/2	1/8	30511	39711	30776	30816
7/64	3/8	1-1/2	1/8	30513	39713	30777	30817
1/8	3/8	1-1/2	1/8	30577	39777	30809	30849
*1/8	1/2	1-1/2	1/8	30515	39715	30778	30818
9/64	1/2	2	3/16	30517	39717	30779	30819
5/32	1/2	2	3/16	30519	39719	30780	30820
11/64	5/8	2	3/16	30521	39721	30781	30821
*3/16	5/8	2	3/16	30523	39723	30782	30822
13/64	5/8	2-1/2	1/4	30525	39725	30783	30823
7/32	5/8	2-1/2	1/4	30527	39727	30784	30824
15/64	3/4	2-1/2	1/4	30529	39729	30785	30825
*1/4	3/4	2-1/2	1/4	30531	39731	30786	30826
17/64	3/4	2-1/2	5/16	30533	39733	30787	30827
9/32	3/4	2-1/2	5/16	30535	39735	30788	30828
19/64	13/16	2-1/2	5/16	30537	39737	30789	30829
*5/16	13/16	2-1/2	5/16	30539	39739	30790	30830
21/64	1	2-1/2	3/8	30541	39741	30791	30831
11/32	1	2-1/2	3/8	30543	39743	30792	30832
23/64	1	2-1/2	3/8	30545	39745	30793	30833
*3/8	1	2-1/2	3/8	30547	39747	30794	30834
25/64	1	2-3/4	7/16	30549	39749	30795	30835
13/32	1	2-3/4	7/16	30551	39751	30796	30836
27/64	1	2-3/4	7/16	30553	39753	30797	30837
7/16	1	2-3/4	7/16	30555	39755	30798	30838
29/64	1	3	1/2	30557	39757	30799	30839
15/32	1	3	1/2	30559	39759	30800	30840
31/64	1	3	1/2	30561	39761	30801	30841
*1/2	1	3	1/2	30563	39763	30802	30842
9/16	1-1/8	3-1/2	9/16	30565	39765	30803	30843
5/8	1-1/4	3-1/2	5/8	30567	39767	30804	30844
11/16	1-3/8	4	3/4	30569	39769	30805	30845
3/4	1-1/2	4	3/4	30571	39771	30806	30846
7/8	1-1/2	4	7/8	30573	39773	30807	30847
1	1-1/2	4	1	30575	39775	30808	30848
*Series 5 Set				30589	39789	30810	30850

- STEELS
- STAINLESS STEELS
- CAST IRON
- HIGH TEMP ALLOYS
- TITANIUM
- HARDENED STEELS
- NON-FERROUS
- PLASTICS/COMPOSITES

For patent information visit www.ksptpatents.com

3 Flute Square End

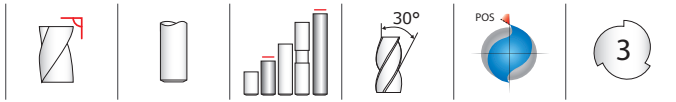

**5M•
5XLM**
METRIC SERIES

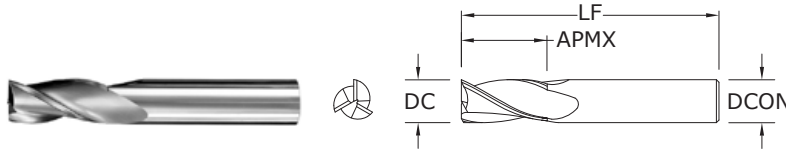

TOLERANCES (mm)

DC = +0,000/-0,050
DCON = h₆

- STEELS
- STAINLESS STEELS
- CAST IRON
- HIGH TEMP ALLOYS
- TITANIUM
- HARDENED STEELS
- NON-FERROUS
- PLASTICS/COMPOSITES

For patent information visit www.ksptpatents.com

mm				EDP NO.				SERIES
CUTTING DIAMETER DC	LENGTH OF CUT APMX	OVERALL LENGTH LF	SHANK DIAMETER DCON	UNCOATED	Ti-NAMITE (TiN)	Ti-NAMITE-C (TiCN)	Ti-NAMITE-A (AlTiN)	
1,0	4,0	38,0	3,0	40505	48756	48778	48799	5M
1,5	4,5	38,0	3,0	40509	48757	48779	48800	5M
2,0	6,3	38,0	3,0	40513	48758	48780	48801	5M
2,5	9,5	38,0	3,0	40517	48759	48781	48802	5M
3,0	12,0	38,0	3,0	40521	48760	48782	48803	5M
3,0	25,0	75,0	3,0	43501	49466	49479	49492	5XLM
3,5	12,0	50,0	4,0	40525	48761	48783	48804	5M
4,0	14,0	50,0	4,0	40529	48762	48784	48805	5M
4,0	25,0	75,0	4,0	43503	49467	49480	49493	5XLM
4,5	16,0	50,0	6,0	40533	48763	48785	48806	5M
5,0	16,0	50,0	6,0	40537	48764	48786	48807	5M
5,0	25,0	75,0	5,0	43507	49469	49482	49495	5XLM
6,0	19,0	50,0	6,0	40541	48765	48787	48808	5M
6,0	25,0	75,0	6,0	43505	49468	49481	49494	5XLM
7,0	19,0	63,0	8,0	40545	48766	48788	48809	5M
8,0	20,0	63,0	8,0	40549	48767	48789	48810	5M
8,0	25,0	75,0	8,0	43515	49470	49483	49496	5XLM
9,0	22,0	75,0	10,0	40553	48768	48790	48811	5M
10,0	22,0	75,0	10,0	40557	48769	48791	48812	5M
10,0	38,0	100,0	10,0	43525	49471	49484	49497	5XLM
11,0	25,0	75,0	12,0	40561	48770	48792	48813	5M
12,0	25,0	75,0	12,0	40565	48771	48793	48814	5M
12,0	50,0	100,0	12,0	43535	49472	49485	49498	5XLM
12,0	75,0	150,0	12,0	43545	49473	49486	49499	5XLM
14,0	32,0	89,0	14,0	40569	48772	48794	48815	5M
14,0	75,0	150,0	14,0	43555	49474	49487	49500	5XLM
16,0	32,0	89,0	16,0	40573	48773	48795	48816	5M
16,0	75,0	150,0	16,0	43565	49475	49488	49501	5XLM
18,0	38,0	100,0	18,0	40577	48774	48796	48817	5M
18,0	75,0	150,0	18,0	43575	49476	49489	49502	5XLM
20,0	38,0	100,0	20,0	40581	48775	48797	48818	5M
20,0	75,0	150,0	20,0	43585	49477	49490	49503	5XLM
25,0	38,0	100,0	25,0	40585	48776	48798	48819	5M
25,0	75,0	150,0	25,0	43595	49478	49491	49504	5XLM

FRACTIONAL 3 Flute Ball End

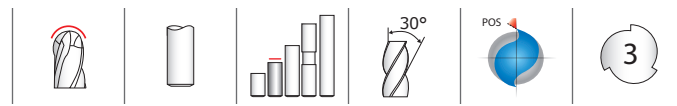

TOLERANCES (inch)
 DC = -0.0000/-0.0020
 DCON = h₆
 RE = +0.0000/-0.0010

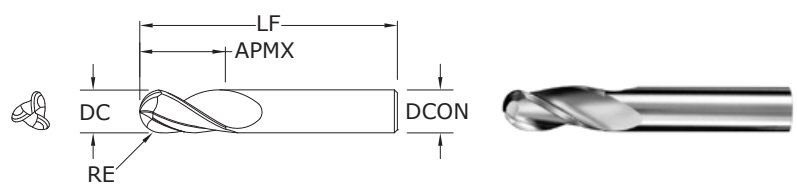

5B
 FRACTIONAL SERIES

inch				EDP NO.			
CUTTING DIAMETER DC	LENGTH OF CUT APMX	OVERALL LENGTH LF	SHANK DIAMETER DCON	UNCOATED	Ti-NAMITE (TiN)	Ti-NAMITE-C (TiCN)	Ti-NAMITE-A (AlTiN)
1/64	1/32	1-1/2	1/8	30502	30851	30602	31130
1/32	5/64	1-1/2	1/8	30504	30852	30604	31131
3/64	7/64	1-1/2	1/8	30506	30853	30606	31132
1/16	3/16	1-1/2	1/8	30508	30854	30608	31133
5/64	3/16	1-1/2	1/8	30510	30855	30610	31134
3/32	9/32	1-1/2	1/8	30512	30856	30612	31135
7/64	3/8	1-1/2	1/8	30514	30857	30902	31136
1/8	3/8	1-1/2	1/8	30578	30889	30943	31168
*1/8	1/2	1-1/2	1/8	30516	30858	30904	31137
9/64	1/2	2	3/16	30518	30859	30906	31138
5/32	1/2	2	3/16	30520	30860	30908	31139
11/64	5/8	2	3/16	30522	30861	30910	31140
*3/16	5/8	2	3/16	30524	30862	30912	31141
13/64	5/8	2-1/2	1/4	30526	30863	30914	31142
7/32	5/8	2-1/2	1/4	30528	30864	30916	31143
15/64	3/4	2-1/2	1/4	30530	30865	30918	31144
*1/4	3/4	2-1/2	1/4	30532	30866	30920	31145
17/64	3/4	2-1/2	5/16	30534	30867	30921	31146
9/32	3/4	2-1/2	5/16	30536	30868	30922	31147
19/64	13/16	2-1/2	5/16	30538	30869	30923	31148
*5/16	13/16	2-1/2	5/16	30540	30870	30924	31149
21/64	1	2-1/2	3/8	30542	30871	30925	31150
11/32	1	2-1/2	3/8	30544	30872	30926	31151
23/64	1	2-1/2	3/8	30546	30873	30927	31152
*3/8	1	2-1/2	3/8	30548	30874	30928	31153
25/64	1	2-3/4	7/16	30550	30875	30929	31154
13/32	1	2-3/4	7/16	30552	30876	30930	31155
27/64	1	2-3/4	7/16	30554	30877	30931	31156
7/16	1	2-3/4	7/16	30556	30878	30932	31157
29/64	1	3	1/2	30558	30879	30933	31158
15/32	1	3	1/2	30560	30880	30934	31159
31/64	1	3	1/2	30562	30881	30935	31160
*1/2	1	3	1/2	30564	30882	30936	31161
9/16	1-1/8	3-1/2	9/16	30566	30883	30937	31162
5/8	1-1/4	3-1/2	5/8	30568	30884	30938	31163
11/16	1-3/8	4	3/4	30570	30885	30939	31164
3/4	1-1/2	4	3/4	30572	30886	30940	31165
7/8	1-1/2	4	7/8	30574	30887	30941	31166
1	1-1/2	4	1	30576	30888	30942	31167
				30590	30900	30944	31169

- STEELS
- STAINLESS STEELS
- CAST IRON
- HIGH TEMP ALLOYS
- TITANIUM
- HARDENED STEELS
- NON-FERROUS
- PLASTICS/COMPOSITES

For patent information visit www.kspatents.com

*Series 5B Set
 RE = 1/2 Cutting Diameter (DC)

3 Flute Ball End

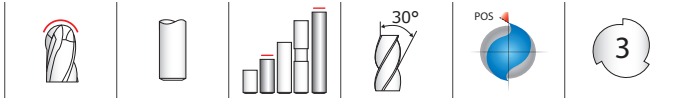

5MB• 5XLMB

METRIC SERIES

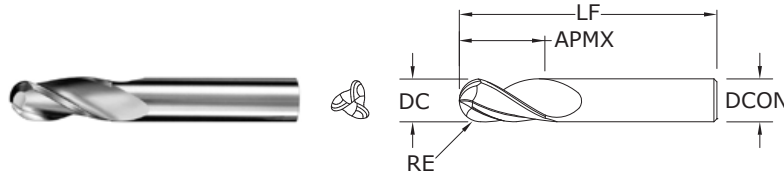

TOLERANCES (mm)

DC = +0,000/-0,050
 DCON = h₆
 RE = +0,000/-0,025

- STEELS
- STAINLESS STEELS
- CAST IRON
- HIGH TEMP ALLOYS
- TITANIUM
- HARDENED STEELS
- NON-FERROUS
- PLASTICS/COMPOSITES

For patent information visit www.ksptpatents.com

CUTTING DIAMETER DC	LENGTH OF CUT APMX	OVERALL LENGTH LF	SHANK DIAMETER DCON	EDP NO.				SERIES
				UNCOATED	Ti-NAMITE (TiN)	Ti-NAMITE-C (TiCN)	Ti-NAMITE-A (AlTiN)	
1,0	4,0	38,0	3,0	40506	48820	48842	48863	5MB
1,5	4,5	38,0	3,0	40510	48821	48843	48864	5MB
2,0	6,3	38,0	3,0	40514	48822	48844	48865	5MB
2,5	9,5	38,0	3,0	40518	48823	48845	48866	5MB
3,0	12,0	38,0	3,0	40522	48824	48846	48867	5MB
3,0	25,0	75,0	3,0	43502	49583	49596	49609	5XLMB
3,5	12,0	50,0	4,0	40526	48825	48847	48868	5MB
4,0	14,0	50,0	4,0	40530	48826	48848	48869	5MB
4,0	25,0	75,0	4,0	43504	49584	49597	49610	5XLMB
4,5	16,0	50,0	6,0	40534	48827	48849	48870	5MB
5,0	16,0	50,0	6,0	40538	48828	48850	48871	5MB
5,0	25,0	75,0	5,0	43508	49586	49599	49612	5XLMB
6,0	19,0	50,0	6,0	40542	48829	48851	48872	5MB
6,0	25,0	75,0	6,0	43506	49585	49598	49611	5XLMB
7,0	19,0	63,0	8,0	40546	48830	48852	48873	5MB
8,0	20,0	63,0	8,0	40550	48831	48853	48874	5MB
8,0	25,0	75,0	8,0	43516	49587	49600	49613	5XLMB
9,0	22,0	75,0	10,0	40554	48832	48854	48875	5MB
10,0	22,0	75,0	10,0	40558	48833	48855	48876	5MB
10,0	38,0	100,0	10,0	43526	49588	49601	49614	5XLMB
11,0	25,0	75,0	12,0	40562	48834	48856	48877	5MB
12,0	25,0	75,0	12,0	40566	48835	48857	48878	5MB
12,0	50,0	100,0	12,0	43536	49589	49602	49615	5XLMB
12,0	75,0	150,0	12,0	43546	49590	49603	49616	5XLMB
14,0	32,0	89,0	14,0	40570	48836	48858	48879	5MB
14,0	75,0	150,0	14,0	43556	49591	49604	49617	5XLMB
16,0	32,0	89,0	16,0	40574	48837	48859	48880	5MB
16,0	75,0	150,0	16,0	43566	49592	49605	49618	5XLMB
18,0	38,0	100,0	18,0	40578	48838	48860	48881	5MB
18,0	75,0	150,0	18,0	43576	49593	49606	49619	5XLMB
20,0	38,0	100,0	20,0	40582	48839	48861	48882	5MB
20,0	75,0	150,0	20,0	43586	49594	49607	49620	5XLMB
25,0	38,0	100,0	25,0	40586	48840	48862	48883	5MB
25,0	75,0	150,0	25,0	43596	49595	49608	49621	5XLMB

RE = 1/2 Cutting Diameter (DC)

Tapered Square End

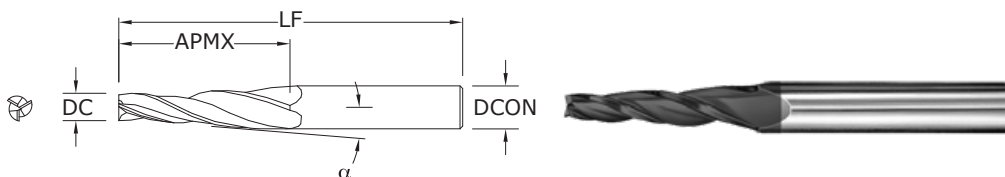
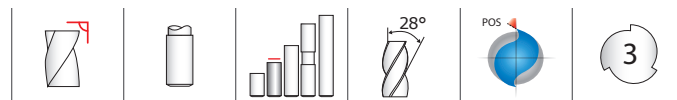

TOLERANCES (inch)

DC = -0.0000/-0.0020
DCON = h₆

23
FRACTIONAL SERIES

SHANK DIAMETER DCON	CENTER LINE ANGLE α	inch			EDP NO.			
		SMALL DIAMETER DC	LENGTH OF CUT APMX	OVERALL LENGTH LF	UNCOATED	Ti-NAMITE (TiN)	Ti-NAMITE-C (TiCN)	Ti-NAMITE-A (AlTiN)
1/4	1°	1/8	1-1/2	3	32301	32370	32302	32345
1/4	1°30'	1/8	1-1/2	3	32303	32371	32304	32346
1/4	2°	1/8	1-1/4	3	32305	32372	32306	32347
1/4	3°	1/8	1	3	32307	32373	32308	32348
1/4	5°	1/8	3/4	3	32309	32374	32310	32349
1/4	7°	1/8	1/2	3	32311	32375	32312	32350
1/4	10°	3/32	1/2	3	32313	32376	32314	32351
3/8	1°	3/16	1-3/4	3-1/2	32315	32377	32316	32352
3/8	1°30'	3/16	1-3/4	3-1/2	32317	32378	32318	32353
3/8	2°	3/16	1-3/4	3-1/2	32319	32379	32320	32354
3/8	3°	5/32	1-3/4	3-1/2	32321	32380	32322	32355
3/8	5°	1/8	1-1/2	3-1/2	32323	32381	32324	32356
3/8	7°	1/8	1	3-1/2	32325	32382	32326	32357
3/8	10°	1/8	3/4	3-1/2	32327	32383	32328	32358
1/2	1°	1/4	2	4	32329	32384	32330	32359
1/2	2°	1/4	2	4	32333	32385	32334	32360
1/2	3°	1/4	2	4	32335	32386	32336	32361
1/2	5°	1/4	1-1/4	4	32337	32387	32338	32362
1/2	7°	3/16	1-1/4	4	32339	32388	32340	32363
1/2	10°	1/8	1	4	32341	32389	32342	32364

- STEELS
- STAINLESS STEELS
- CAST IRON
- HIGH TEMP ALLOYS
- TITANIUM
- HARDENED STEELS
- NON-FERROUS
- PLASTICS/COMPOSITES

For patent information visit www.ksptpatents.com

Tapered Ball End

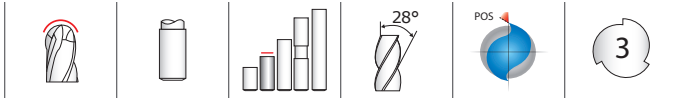

24 FRACTIONAL SERIES

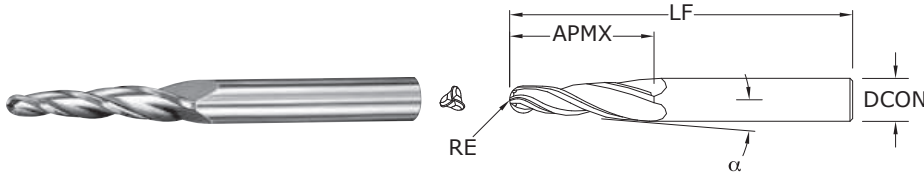

TOLERANCES (inch)

DCON = h_6
RE = $+0.0000/-0.0010$

- STEELS
- STAINLESS STEELS
- CAST IRON
- HIGH TEMP ALLOYS
- TITANIUM
- HARDENED STEELS
- NON-FERROUS
- PLASTICS/COMPOSITES

For patent information visit www.ksptpatents.com

SHANK DIAMETER DCON	CENTER LINE ANGLE α	inch			EDP NO.			
		RADIUS RE	LENGTH OF CUT APMX	OVERALL LENGTH LF	UNCOATED	Ti-NAMITE (TiN)	Ti-NAMITE-C (TiCN)	Ti-NAMITE-A (AlTiN)
1/4	1°	.062	1-1/2	3	32402	32403	32445	32470
1/4	1°30'	.062	1-1/2	3	32404	32405	32446	32471
1/4	2°	.062	1-1/4	3	32406	32407	32447	32472
1/4	3°	.062	1	3	32408	32409	32448	32473
1/4	5°	.062	3/4	3	32410	32411	32449	32474
1/4	7°	.062	1/2	3	32412	32413	32450	32475
1/4	10°	.047	1/2	3	32414	32415	32451	32476
3/8	1°	.093	1-3/4	3-1/2	32416	32417	32452	32477
3/8	1°30'	.093	1-3/4	3-1/2	32418	32419	32453	32478
3/8	2°	.093	1-3/4	3-1/2	32420	32421	32454	32479
3/8	3°	.078	1-3/4	3-1/2	32422	32423	32455	32480
3/8	5°	.062	1-1/2	3-1/2	32424	32425	32456	32481
3/8	7°	.062	1	3-1/2	32426	32427	32457	32482
3/8	10°	.062	3/4	3-1/2	32428	32429	32458	32483
1/2	1°	.125	2	4	32430	32431	32459	32484
1/2	2°	.125	2	4	32434	32435	32460	32485
1/2	3°	.125	2	4	32436	32437	32461	32486
1/2	5°	.125	1-1/4	4	32438	32439	32462	32487
1/2	7°	.093	1-1/4	4	32440	32441	32463	32488
1/2	10°	.062	1	4	32442	32443	32464	32489

4 Flute Square End • 4 Flute Corner Radius

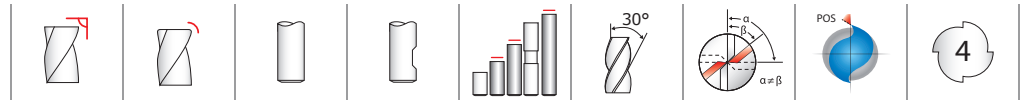

TOLERANCES (inch)
 DC = +0.0000/-0.0020
 1CR DC = -0.0010/-0.0020
 DCON = h₆
 RE = +0.000/-0.002

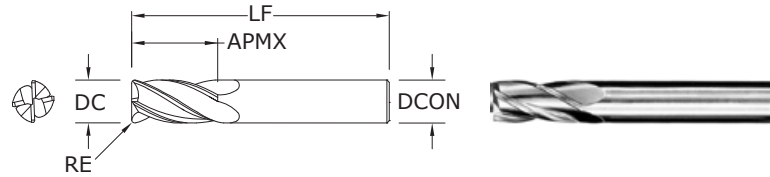

**1•1L•
1EL•1CR**
FRACTIONAL SERIES

inch					EDP NO.							SERIES
CUTTING DIAMETER DC	LENGTH OF CUT APMX	OVERALL LENGTH LF	SHANK DIAMETER DCON	CORNER RADIUS RE	UNCOATED	UNCOATED W/ FLAT	Ti-NAMITE (TiN)	Ti-NAMITE-C (TiCN)	Ti-NAMITE-A (AlTiN)	Ti-NAMITE-A (AlTiN) W/FLAT	Di-NAMITE* (Diamond)	
1/64	1/32	1-1/2	1/8	-	30101	-	39101	39001	30191	-	-	1
1/32	5/64	1-1/2	1/8	-	30103	-	39103	39003	30192	-	-	1
3/64	7/64	1-1/2	1/8	-	30105	-	39105	39005	30193	-	-	1
1/16	3/16	1-1/2	1/8	-	30107	-	39107	39007	30194	-	91268	1
5/64	3/16	1-1/2	1/8	-	30109	-	39109	39009	30195	-	-	1
3/32	9/32	1-1/2	1/8	-	30111	-	39111	39011	30196	-	-	1
7/64	3/8	1-1/2	1/8	-	30113	-	39113	39013	30197	-	-	1
1/8	3/8	1-1/2	1/8	-	30177	-	39177	39077	30029	-	-	1
*1/8	1/2	1-1/2	1/8	-	30115	-	39115	39015	30198	-	91272	1
**1/8	1/2	1-1/2	1/8	.015	38001	38002	38115	38157	-	-	-	1CR
**1/8	1/2	1-1/2	1/8	.020	38003	38004	38116	38158	-	-	-	1CR
1/8	3/4	2-1/4	1/8	-	33141	-	31727	31737	31747	-	-	1L
1/8	1	3	1/8	-	33143	-	31860	31870	31880	-	-	1EL
9/64	1/2	2	3/16	-	30117	-	39117	39017	30199	-	-	1
5/32	1/2	2	3/16	-	30119	-	39119	39019	30000	-	-	1
11/64	5/8	2	3/16	-	30121	-	39121	39021	30001	-	-	1
*3/16	5/8	2	3/16	-	30123	-	39123	39023	30002	-	91276	1
**3/16	5/8	2	3/16	.015	38009	38010	38117	38159	-	-	-	1CR
**3/16	5/8	2	3/16	.020	38011	38012	38118	38160	-	-	-	1CR
**3/16	5/8	2	3/16	.030	38013	38014	38119	38161	-	-	-	1CR
3/16	3/4	2-1/2	3/16	-	33101	-	31728	31738	31748	-	-	1L
3/16	1-1/8	3	3/16	-	33121	-	31861	31871	31881	-	-	1EL
13/64	5/8	2-1/2	1/4	-	30125	-	39125	39025	30003	-	-	1
7/32	5/8	2-1/2	1/4	-	30127	-	39127	39027	30004	-	-	1
15/64	3/4	2-1/2	1/4	-	30129	-	39129	39029	30005	-	-	1
*1/4	3/4	2-1/2	1/4	-	30131	30300	39131	39031	30006	-	91280	1
**1/4	3/4	2-1/2	1/4	.015	38019	38020	38120	38162	-	-	-	1CR
**1/4	3/4	2-1/2	1/4	.020	38021	38022	38121	38163	-	-	-	1CR
**1/4	3/4	2-1/2	1/4	.030	38023	38024	38122	38164	-	-	-	1CR
**1/4	3/4	2-1/2	1/4	.045	38025	38026	38123	38165	-	-	-	1CR

- STEELS
- STAINLESS STEELS
- CAST IRON
- HIGH TEMP ALLOYS
- TITANIUM
- HARDENED STEELS
- NON-FERROUS
- PLASTICS/COMPOSITES

For patent information visit www.ksptpatents.com

continued on next page

4 Flute Square End • 4 Flute Corner Radius

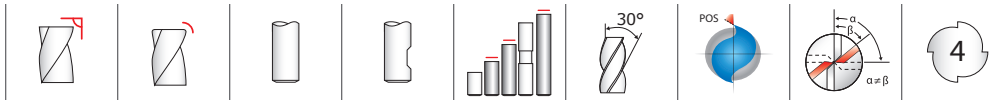

**1.1L •
1EL • 1CR**
FRACTIONAL SERIES

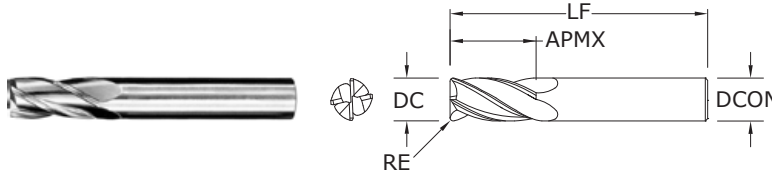

TOLERANCES (inch)

DC = +0.0000/-0.0020
 1CR DC = -0.0010/-0.0020
 DCON = h_6
 RE = +0.000/-0.002

CONTINUED

- STEELS
- STAINLESS STEELS
- CAST IRON
- HIGH TEMP ALLOYS
- TITANIUM
- HARDENED STEELS
- NON-FERROUS
- PLASTICS/COMPOSITES

For patent information visit www.ksptpatents.com

CUTTING DIAMETER DC	LENGTH OF CUT APMX	inch			EDP NO.							SERIES
		OVERALL LENGTH LF	SHANK DIAMETER DCON	CORNER RADIUS RE	UNCOATED	UNCOATED W/ FLAT	Ti-NAMITE (TiN)	Ti-NAMITE-C (TiCN)	Ti-NAMITE-A (AlTiN)	Ti-NAMITE-A (AlTiN) W/FLAT	Di-NAMITE® (Diamond)	
1/4	1-1/8	3	1/4	—	33103	—	31729	31739	31749	—	—	1L
1/4	1-1/2	4	1/4	—	33123	—	31862	31872	31882	—	—	1EL
17/64	3/4	2-1/2	5/16	—	30133	—	39133	39033	30007	—	—	1
9/32	3/4	2-1/2	5/16	—	30135	—	39135	39035	30008	—	—	1
19/64	13/16	2-1/2	5/16	—	30137	—	39137	39037	30009	—	—	1
*5/16	13/16	2-1/2	5/16	—	30139	—	39139	39039	30010	—	91284	1
**5/16	13/16	2-1/2	5/16	.015	38031	38032	38124	38166	—	—	—	1CR
**5/16	13/16	2-1/2	5/16	.020	38033	38034	38125	38167	—	—	—	1CR
**5/16	13/16	2-1/2	5/16	.030	38035	38036	38126	38168	—	—	—	1CR
**5/16	13/16	2-1/2	5/16	.045	38037	38038	38127	38169	—	—	—	1CR
5/16	1-1/8	3	5/16	—	33105	—	31730	31740	31763	—	—	1L
5/16	1-5/8	4	5/16	—	33125	—	31863	31873	31883	—	—	1EL
21/64	1	2-1/2	3/8	—	30141	—	39141	39041	30011	—	—	1
11/32	1	2-1/2	3/8	—	30143	—	39143	39043	30012	—	—	1
23/64	1	2-1/2	3/8	—	30145	—	39145	39045	30013	—	—	1
*3/8	1	2-1/2	3/8	—	30147	30179	39147	39047	30014	30379	91288	1
3/8	1	2-1/2	3/8	.015	38045	38046	38128	38170	—	—	—	1CR
3/8	1	2-1/2	3/8	.020	38047	38048	38129	38171	—	—	—	1CR
3/8	1	2-1/2	3/8	.030	38049	38050	38130	38172	—	—	—	1CR
3/8	1	2-1/2	3/8	.045	38051	38052	38131	38173	—	—	—	1CR
3/8	1-1/8	3	3/8	—	33107	—	31731	31741	31764	—	—	1L
3/8	1-3/4	4	3/8	—	33127	—	31864	31874	31884	—	—	1EL
25/64	1	2-3/4	7/16	—	30149	—	39149	39049	30015	—	—	1
13/32	1	2-3/4	7/16	—	30151	—	39151	39051	30016	—	—	1
27/64	1	2-3/4	7/16	—	30153	—	39153	39053	30017	—	—	1
7/16	1	2-3/4	7/16	—	30155	—	39155	39055	30018	—	—	1
7/16	2	4-1/2	7/16	—	33109	—	31732	31742	31765	—	—	1L
7/16	3	6	7/16	—	33129	—	31865	31875	31885	—	—	1EL
29/64	1	3	1/2	—	30157	—	39157	39057	30019	—	—	1
15/32	1	3	1/2	—	30159	—	39159	39059	30020	—	—	1

continued on next page

4 Flute Square End • 4 Flute Corner Radius

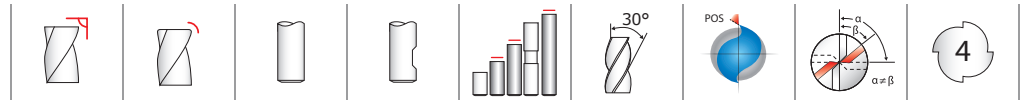

TOLERANCES (inch)

DC = +0.0000/-0.0020
 1CR DC = -0.0010/-0.0020
 DCON = h₆
 RE = +0.000/-0.002

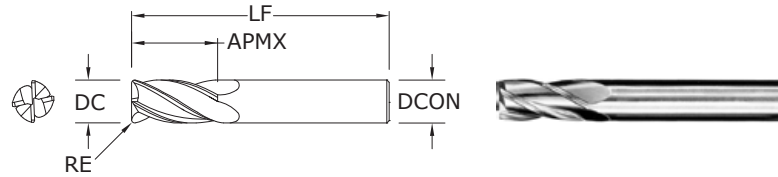

**1•1L•
1EL•1CR**
FRACTIONAL SERIES

inch					EDP NO.							SERIES
CUTTING DIAMETER DC	LENGTH OF CUT APMX	OVERALL LENGTH LF	SHANK DIAMETER DCON	CORNER RADIUS RE	UNCOATED	UNCOATED W/ FLAT	Ti-NAMITE (TiN)	Ti-NAMITE-C (TiCN)	Ti-NAMITE-A (AlTiN)	Ti-NAMITE-A (AlTiN) W/FLAT	Di-NAMITE® (Diamond)	
31/64	1	3	1/2	-	30161	-	39161	39061	30021	-	-	1
*1/2	1	3	1/2	-	30163	30180	39163	39063	30022	30380	91292	1
1/2	1	3	1/2	.015	38059	38060	38132	38174	-	-	-	1CR
1/2	1	3	1/2	.020	38061	38062	38133	38175	-	-	-	1CR
1/2	1	3	1/2	.030	38063	38064	38134	38176	-	-	-	1CR
1/2	1	3	1/2	.045	38065	38066	38135	38177	-	-	-	1CR
1/2	1	3	1/2	.060	38067	38068	38136	38178	-	-	-	1CR
1/2	2	4-1/2	1/2	-	33111	-	31733	31743	31766	-	-	1L
1/2	3	6	1/2	-	33131	-	31866	31876	31886	-	-	1EL
9/16	1-1/8	3-1/2	9/16	-	30165	-	39165	39065	30023	-	-	1
5/8	1-1/4	3-1/2	5/8	-	30167	30181	39167	39067	30024	30381	-	1
5/8	1-1/4	3-1/2	5/8	.015	38073	38074	38137	38179	-	-	-	1CR
5/8	1-1/4	3-1/2	5/8	.020	38075	38076	38138	38180	-	-	-	1CR
5/8	1-1/4	3-1/2	5/8	.030	38077	38078	38139	38181	-	-	-	1CR
5/8	1-1/4	3-1/2	5/8	.045	38079	38080	38140	38182	-	-	-	1CR
5/8	1-1/4	3-1/2	5/8	.060	38081	38082	38141	38183	-	-	-	1CR
5/8	1-1/4	3-1/2	5/8	.090	38083	38084	38142	38184	31767	-	-	1L
5/8	3	6	5/8	-	33133	-	31867	31877	31887	-	-	1EL
11/16	1-3/8	4	3/4	-	30169	-	39169	39069	30025	-	-	1
3/4	1-1/2	4	3/4	-	30171	30182	39171	39071	30026	30382	-	1
3/4	1-1/2	4	3/4	.015	38087	38088	38143	38185	-	-	-	1CR
3/4	1-1/2	4	3/4	.020	38089	38090	38144	38186	-	-	-	1CR
3/4	1-1/2	4	3/4	.030	38091	38092	38145	38187	-	-	-	1CR
3/4	1-1/2	4	3/4	.045	38093	38094	38146	38188	-	-	-	1CR
3/4	1-1/2	4	3/4	.060	38095	38096	38147	38189	-	-	-	1CR
3/4	1-1/2	4	3/4	.090	38097	38098	38148	38190	-	-	-	1CR
3/4	1-1/2	4	3/4	.125	38099	38100	38149	38191	-	-	-	1CR
3/4	2-1/4	5	3/4	-	33115	-	31735	31745	31768	-	-	1L
3/4	3	6	3/4	-	33135	-	31868	31878	31888	-	-	1EL
7/8	1-1/2	4	7/8	-	30173	-	39173	39073	30027	-	-	1

CONTINUED

- STEELS
- STAINLESS STEELS
- CAST IRON
- HIGH TEMP ALLOYS
- TITANIUM
- HARDENED STEELS
- NON-FERROUS
- PLASTICS/COMPOSITES

For patent information visit www.ksptpatents.com

continued on next page

4 Flute Square End • 4 Flute Corner Radius

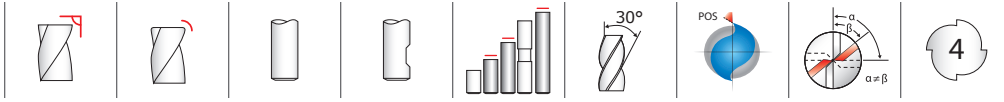

**1.1L •
1EL • 1CR**
FRACTIONAL SERIES

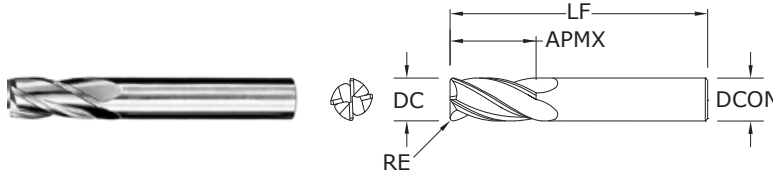

TOLERANCES (inch)

DC = +0.0000/-0.0020
 1CR DC = -0.0010/-0.0020
 DCON = h_6
 RE = +0.000/-0.002

CONTINUED

- STEELS
- STAINLESS STEELS
- CAST IRON
- HIGH TEMP ALLOYS
- TITANIUM
- HARDENED STEELS
- NON-FERROUS
- PLASTICS/COMPOSITES

CUTTING DIAMETER DC	LENGTH OF CUT APMX	inch			EDP NO.							SERIES
		OVERALL LENGTH LF	SHANK DIAMETER DCON	CORNER RADIUS RE	UNCOATED	UNCOATED W/ FLAT	Ti-NAMITE (TiN)	Ti-NAMITE-C (TiCN)	Ti-NAMITE-A (AlTiN)	Ti-NAMITE-A (AlTiN) W/FLAT	Di-NAMITE® (Diamond)	
1	1-1/2	4	1	—	30175	30183	39175	39075	30028	30383	—	1
1	1-1/2	4	1	.015	38101	38102	38150	38192	—	—	—	1CR
1	1-1/2	4	1	.020	38103	38104	38151	38193	—	—	—	1CR
1	1-1/2	4	1	.030	38105	38106	38152	38194	—	—	—	1CR
1	1-1/2	4	1	.045	38107	38108	38153	38195	—	—	—	1CR
1	1-1/2	4	1	.060	38109	38110	38154	38196	—	—	—	1CR
1	1-1/2	4	1	.090	38111	38112	38155	38197	—	—	—	1CR
1	1-1/2	4	1	.125	38113	38114	38156	38198	—	—	—	1CR
1	2-1/4	5	1	—	33117	—	31736	31746	31769	—	—	1L
1	3	6	1	—	33137	—	31869	31879	31889	—	—	1EL
*Series 1 Set					30189	—	39189	39089	30030	—	—	1

**Without Flat

For patent information visit www.ksptpatents.com

4 Flute Square End • 4 Flute Corner Radius

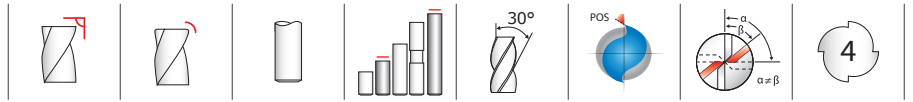

TOLERANCES (mm)

DC = +0,000/-0,050
 DCON = h₆
 RE = +0,000/-0,050

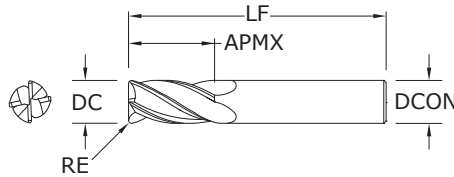

1M • 1XLM • 1MCR
 METRIC SERIES

CUTTING DIAMETER DC	LENGTH OF CUT APMX	mm			EDP NO.				SERIES
		OVERALL LENGTH LF	CORNER RADIUS RE	SHANK DIAMETER DCON	UNCOATED	Ti-NAMITE (TiN)	Ti-NAMITE-C (TiCN)	Ti-NAMITE-A (AlTiN)	
1,0	4,0	38,0	–	3,0	40105	48500	48522	48543	1M
1,5	4,5	38,0	–	3,0	40109	48501	48523	48544	1M
2,0	6,3	38,0	–	3,0	40113	48502	48524	48545	1M
2,5	9,5	38,0	–	3,0	40117	48503	48525	48546	1M
3,0	12,0	38,0	–	3,0	40121	48504	48526	48547	1M
3,0	25,0	75,0	–	3,0	43101	49388	49401	49414	1XLM
3,5	12,0	50,0	–	4,0	40125	48505	48527	48548	1M
4,0	14,0	50,0	–	4,0	40129	48506	48528	48549	1M
4,0	25,0	75,0	–	4,0	43103	49389	49402	49415	1XLM
4,0	14,0	50,0	0,25	4,0	–	–	–	40000	1MCR
4,0	14,0	50,0	0,50	4,0	–	–	–	40001	1MCR
4,0	14,0	50,0	1,00	4,0	–	–	–	40003	1MCR
4,5	16,0	50,0	–	6,0	40133	48507	48529	48550	1M
5,0	16,0	50,0	0,25	6,0	–	–	–	40004	1MCR
5,0	16,0	50,0	0,50	6,0	–	–	–	40005	1MCR
5,0	16,0	50,0	1,00	6,0	–	–	–	40007	1MCR
5,0	16,0	50,0	–	6,0	40137	48508	48530	48551	1M
5,0	25,0	75,0	–	5,0	43107	49391	49404	49417	1XLM
6,0	19,0	50,0	–	6,0	40141	48509	48531	48552	1M
6,0	25,0	75,0	–	6,0	43105	49390	49403	49416	1XLM
6,0	19,0	50,0	0,25	6,0	–	–	–	40009	1MCR
6,0	19,0	50,0	0,50	6,0	–	–	–	40010	1MCR
6,0	19,0	50,0	0,75	6,0	–	–	–	40011	1MCR
6,0	19,0	50,0	1,00	6,0	–	–	–	40012	1MCR
7,0	19,0	63,0	–	8,0	40145	48510	48532	48553	1M
8,0	20,0	63,0	–	8,0	40149	48511	48533	48554	1M
8,0	25,0	75,0	–	8,0	43115	49392	49405	49418	1XLM
8,0	20,0	63,0	0,50	8,0	–	–	–	40015	1MCR
8,0	20,0	63,0	0,75	8,0	–	–	–	40016	1MCR
8,0	20,0	63,0	1,00	8,0	–	–	–	40017	1MCR
8,0	20,0	63,0	1,50	8,0	–	–	–	40019	1MCR
8,0	20,0	63,0	2,00	8,0	–	–	–	40020	1MCR
9,0	22,0	75,0	–	10,0	40153	48512	48534	48555	1M
10,0	22,0	75,0	–	10,0	40157	48513	48535	48556	1M

- STEELS
- STAINLESS STEELS
- CAST IRON
- HIGH TEMP ALLOYS
- TITANIUM
- HARDENED STEELS
- NON-FERROUS
- PLASTICS/COMPOSITES

For patent information visit www.kspatent.com

continued on next page

METRIC

4 Flute Square End • 4 Flute Corner Radius

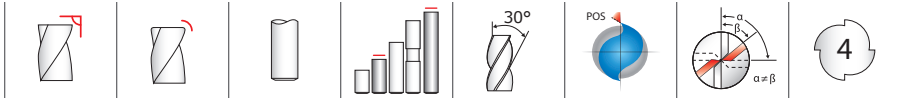

1M • 1XLM • 1MCR
METRIC SERIES

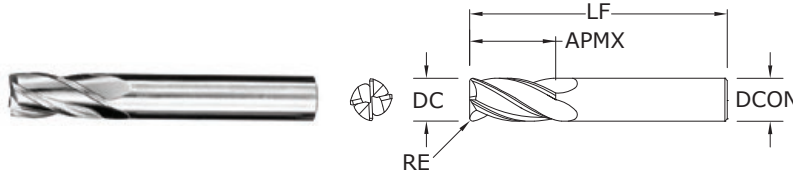

TOLERANCES (mm)

DC = +0,000/-0,050

DCON = h_6

RE = +0,000/-0,050

CONTINUED

- STEELS
- STAINLESS STEELS
- CAST IRON
- HIGH TEMP ALLOYS
- TITANIUM
- HARDENED STEELS
- NON-FERROUS
- PLASTICS/COMPOSITES

For patent information visit www.ksptpatents.com

CUTTING DIAMETER DC	LENGTH OF CUT APMX	mm			EDP NO.				SERIES
		OVERALL LENGTH LF	CORNER RADIUS RE	SHANK DIAMETER DCON	UNCOATED	Ti-NAMITE (TiN)	Ti-NAMITE-C (TiCN)	Ti-NAMITE-A (AlTiN)	
10,0	38,0	100,0	—	10,0	43125	49393	49406	49419	1XLM
10,0	22,0	75,0	0,50	10,0	—	—	—	40021	1MCR
10,0	22,0	75,0	1,00	10,0	—	—	—	40023	1MCR
10,0	22,0	75,0	1,50	10,0	—	—	—	40024	1MCR
10,0	22,0	75,0	2,00	10,0	—	—	—	40025	1MCR
11,0	25,0	75,0	—	12,0	40161	48514	48536	48557	1M
12,0	25,0	75,0	—	12,0	41665	48515	48537	48558	1M
12,0	50,0	100,0	—	12,0	43135	49394	49407	49420	1XLM
12,0	75,0	150,0	—	12,0	43145	49395	49408	49421	1XLM
12,0	25,0	75,0	0,50	12,0	—	—	—	40028	1MCR
12,0	25,0	75,0	1,00	12,0	—	—	—	40030	1MCR
12,0	25,0	75,0	1,50	12,0	—	—	—	40031	1MCR
12,0	25,0	75,0	2,00	12,0	—	—	—	40032	1MCR
14,0	32,0	89,0	—	14,0	40169	48516	48538	48559	1M
14,0	75,0	150,0	—	14,0	43155	49396	49409	49422	1XLM
16,0	32,0	89,0	—	16,0	40173	48517	48539	48560	1M
16,0	75,0	150,0	—	16,0	43165	49397	49410	49423	1XLM
16,0	32,0	89,0	0,50	16,0	—	—	—	40035	1MCR
16,0	32,0	89,0	1,00	16,0	—	—	—	40037	1MCR
16,0	32,0	89,0	1,50	16,0	—	—	—	40038	1MCR
16,0	32,0	89,0	2,00	16,0	—	—	—	40039	1MCR
18,0	38,0	100,0	—	18,0	40177	48518	48540	48561	1M
18,0	75,0	150,0	—	18,0	43175	49398	49411	49424	1XLM
20,0	38,0	100,0	—	20,0	40181	48519	48541	48562	1M
20,0	75,0	150,0	—	20,0	43185	49399	49412	49425	1XLM
25,0	38,0	100,0	—	25,0	40185	48520	48542	48563	1M
25,0	75,0	150,0	—	25,0	43195	49400	49413	49426	1XLM

FRACTIONAL 4 Flute Ball End

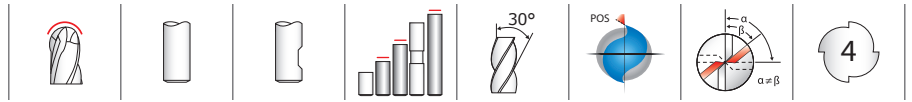

TOLERANCES (inch)

DC = +0.0000/-0.0020

DCON = h_6

RE = +0.0000/-0.0010

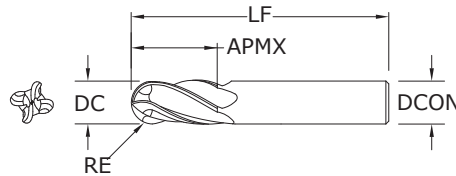

**1B • 1LB •
1ELB**
FRACTIONAL SERIES

inch				EDP NO.							SERIES
CUTTING DIAMETER DC	LENGTH OF CUT APMX	OVERALL LENGTH LF	SHANK DIAMETER DCON	UNCOATED	UNCOATED W/FLAT	Ti-NAMITE (TiN)	Ti-NAMITE-C (TiCN)	Ti-NAMITE-A (AlTiN)	Ti-NAMITE-A (AlTiN) W/FLAT	Di-NAMITE® (Diamond)	
1/64	1/32	1-1/2	1/8	30102	—	39102	39002	30031	—	—	1B
1/32	5/64	1-1/2	1/8	30104	—	39104	39004	30032	—	—	1B
3/64	7/64	1-1/2	1/8	30106	—	39106	39006	30033	—	—	1B
1/16	3/16	1-1/2	1/8	30108	—	39108	39008	30034	—	91269	1B
5/64	3/16	1-1/2	1/8	30110	—	39110	39010	30035	—	—	1B
3/32	9/32	1-1/2	1/8	30112	—	39112	39012	30036	—	—	1B
7/64	3/8	1-1/2	1/8	30114	—	39114	39014	30037	—	—	1B
*1/8	3/8	1-1/2	1/8	30178	—	39178	39078	30069	—	—	1B
1/8	1/2	1-1/2	1/8	30116	—	39116	39016	30038	—	91273	1B
1/8	3/4	2-1/4	1/8	33142	—	31770	31780	31790	—	—	1LB
1/8	1	3	1/8	33144	—	31900	31918	31928	—	—	1ELB
9/64	1/2	2	3/16	30118	—	39118	39018	30039	—	—	1B
5/32	1/2	2	3/16	30120	—	39120	39020	30040	—	—	1B
11/64	5/8	2	3/16	30122	—	39122	39022	30041	—	—	1B
*3/16	5/8	2	3/16	30124	—	39124	39024	30042	—	91277	1B
3/16	3/4	2-1/2	3/16	33102	—	31771	31781	31791	—	—	1LB
3/16	1-1/8	3	3/16	33122	—	31902	31919	31929	—	—	1ELB
13/64	5/8	2-1/2	1/4	30126	—	39126	39026	30043	—	—	1B
7/32	5/8	2-1/2	1/4	30128	—	39128	39028	30044	—	—	1B
15/64	3/4	2-1/2	1/4	30130	—	39130	39030	30045	—	—	1B
*1/4	3/4	2-1/2	1/4	30132	—	39132	39032	30046	—	91281	1B
1/4	1-1/8	3	1/4	33104	—	31772	31782	31792	—	—	1LB
1/4	1-1/2	4	1/4	33124	—	31904	31920	31930	—	—	1ELB
17/64	3/4	2-1/2	5/16	30134	—	39134	39034	30047	—	—	1B
9/32	3/4	2-1/2	5/16	30136	—	39136	39036	30048	—	—	1B
19/64	13/16	2-1/2	5/16	30138	—	39138	39038	30049	—	—	1B
*5/16	13/16	2-1/2	5/16	30140	—	39140	39040	30050	—	91285	1B
5/16	1-1/8	3	5/16	33106	—	31773	31783	31793	—	—	1LB
5/16	1-5/8	4	5/16	33126	—	31906	31921	31931	—	—	1ELB
21/64	1	2-1/2	3/8	30142	—	39142	39042	30051	—	—	1B

RE = 1/2 Cutting Diameter (DC)

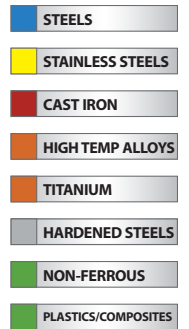

For patent information visit
www.ksptpatents.com

METRIC

4 Flute Ball End



**1MB•
1XLMB**
METRIC SERIES

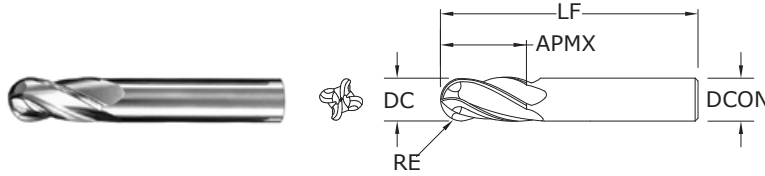

TOLERANCES (mm)

DC = +0,000/-0,050
 DCON = h_6
 RE = +0,000/-0,025

- STEELS
- STAINLESS STEELS
- CAST IRON
- HIGH TEMP ALLOYS
- TITANIUM
- HARDENED STEELS
- NON-FERROUS
- PLASTICS/COMPOSITES

For patent information visit www.ksptpatents.com

mm				EDP NO.				SERIES
CUTTING DIAMETER DC	LENGTH OF CUT APMX	OVERALL LENGTH LF	SHANK DIAMETER DCON	UNCOATED	Ti-NAMITE (TiN)	Ti-NAMITE-C (TiCN)	Ti-NAMITE-A (AlTiN)	
1,0	4,0	38,0	3,0	40106	48564	48586	48607	1MB
1,5	4,5	38,0	3,0	40110	48565	48587	48608	1MB
2,0	6,3	38,0	3,0	40114	48566	48588	48609	1MB
2,5	9,5	38,0	3,0	40118	48567	48589	48610	1MB
3,0	12,0	38,0	3,0	40122	48568	48590	48611	1MB
3,0	25,0	75,0	3,0	43102	49505	49518	49531	1XLMB
3,5	12,0	50,0	4,0	40126	48569	48591	48612	1MB
4,0	14,0	50,0	4,0	40130	48570	48592	48613	1MB
4,0	25,0	75,0	4,0	43104	49506	49519	49532	1XLMB
4,5	16,0	50,0	6,0	40134	48571	48593	48614	1MB
5,0	16,0	50,0	6,0	40138	48572	48594	48615	1MB
5,0	25,0	75,0	5,0	43108	49508	49521	49534	1XLMB
6,0	19,0	50,0	6,0	40142	48573	48595	48616	1MB
6,0	25,0	75,0	6,0	43106	49507	49520	49533	1XLMB
7,0	19,0	63,0	8,0	40146	48574	48596	48617	1MB
8,0	20,0	63,0	8,0	40150	48575	48597	48618	1MB
8,0	25,0	75,0	8,0	43116	49509	49522	49535	1XLMB
9,0	22,0	75,0	10,0	40154	48576	48598	48619	1MB
10,0	22,0	75,0	10,0	40158	48577	48599	48620	1MB
10,0	38,0	100,0	10,0	43126	49510	49523	49536	1XLMB
11,0	25,0	75,0	12,0	40162	48578	48600	48621	1MB
12,0	25,0	75,0	12,0	40166	48579	48601	48622	1MB
12,0	50,0	100,0	12,0	43136	49511	49524	49537	1XLMB
12,0	75,0	150,0	12,0	43146	49512	49525	49538	1XLMB
14,0	32,0	89,0	14,0	40170	48580	48602	48623	1MB
14,0	75,0	150,0	14,0	43156	49513	49526	49539	1XLMB
16,0	32,0	89,0	16,0	40174	48581	48603	48624	1MB
16,0	75,0	150,0	16,0	43166	49514	49527	49540	1XLMB
18,0	38,0	100,0	18,0	40178	48582	48604	48625	1MB
18,0	75,0	150,0	18,0	43176	49515	49528	49541	1XLMB
20,0	38,0	100,0	20,0	40182	48583	48605	48626	1MB
20,0	75,0	150,0	20,0	43186	49516	49529	49542	1XLMB
25,0	38,0	100,0	25,0	40186	48584	48606	48627	1MB
25,0	75,0	150,0	25,0	43196	49517	49530	49543	1XLMB

RE = 1/2 Cutting Diameter (DC)

4 Flute Double End



TOLERANCES (inch)

DC = +0.0000/-0.0020

DCON = h₆

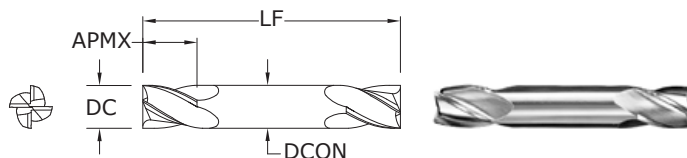

14
FRACTIONAL SERIES

inch				EDP NO.			
CUTTING DIAMETER DC	LENGTH OF CUT APMX	OVERALL LENGTH LF	SHANK DIAMETER DCON	UNCOATED	Ti-NAMITE (TiN)	Ti-NAMITE-C (TiCN)	Ti-NAMITE-A (AlTiN)
1/32	1/16	1-1/2	1/8	31401	31441	39601	31170
3/64	3/32	1-1/2	1/8	31403	31443	39603	31171
1/16	1/8	1-1/2	1/8	31405	31445	39605	31172
5/64	1/8	1-1/2	1/8	31407	31447	39607	31173
3/32	3/16	1-1/2	1/8	31409	31449	39609	31174
7/64	3/16	1-1/2	1/8	31411	31451	39611	31175
*1/8	1/4	1-1/2	1/8	31413	31453	39613	31176
9/64	5/16	2	3/16	31415	31455	39615	31177
5/32	5/16	2	3/16	31417	31457	39617	31178
11/64	5/16	2	3/16	31419	31459	39619	31179
*3/16	3/8	2	3/16	31421	31461	39621	31180
13/64	1/2	2-1/2	1/4	31423	31463	39623	31181
7/32	1/2	2-1/2	1/4	31425	31465	39625	31182
15/64	1/2	2-1/2	1/4	31427	31467	39627	31183
*1/4	1/2	2-1/2	1/4	31429	31469	39629	31184
9/32	1/2	2-1/2	5/16	31431	31471	39631	31185
*5/16	1/2	2-1/2	5/16	31433	31473	39633	31186
*3/8	9/16	2-1/2	3/8	31435	31475	39635	31187
7/16	9/16	2-3/4	7/16	31437	31477	39637	31188
*1/2	5/8	3	1/2	31439	31479	39639	31189
*Series 14 Set				31489	31481	39641	31190

- STEELS
- STAINLESS STEELS
- CAST IRON
- HIGH TEMP ALLOYS
- TITANIUM
- HARDENED STEELS
- NON-FERROUS
- PLASTICS/COMPOSITES

For patent information visit www.ksptpatents.com

TOLERANCES (mm)

DC = +0,000/-0,050

DCON = h₆

14M
METRIC SERIES

mm				EDP NO.			
CUTTING DIAMETER DC	LENGTH OF CUT APMX	OVERALL LENGTH LF	SHANK DIAMETER DCON	UNCOATED	Ti-NAMITE (TiN)	Ti-NAMITE-C (TiCN)	Ti-NAMITE-A (AlTiN)
1,0	2,0	38,0	3,0	41405	48884	48905	48926
1,5	3,0	38,0	3,0	41409	48885	48906	48927
2,0	4,0	38,0	3,0	41413	48886	48907	48928
2,5	5,0	38,0	3,0	41417	48887	48908	48929
3,0	6,0	38,0	3,0	41421	48888	48909	48930
3,5	7,0	50,0	4,0	41425	48889	48910	48931
4,0	8,0	50,0	4,0	41429	48890	48911	48932
4,5	9,5	63,0	4,5	41433	48891	48912	48933
5,0	10,0	63,0	5,0	41437	48892	48913	48934
6,0	12,0	63,0	6,0	41441	48893	48914	48935
7,0	12,0	63,0	8,0	41445	48894	48915	48936
8,0	12,0	63,0	8,0	41449	48895	48916	48937
9,0	14,0	75,0	9,0	41453	48896	48917	48938
10,0	14,0	75,0	10,0	41457	48897	48918	48939
11,0	14,0	75,0	12,0	41461	48898	48919	48940
12,0	16,0	75,0	12,0	41465	48899	48920	48941

- STEELS
- STAINLESS STEELS
- CAST IRON
- HIGH TEMP ALLOYS
- TITANIUM
- HARDENED STEELS
- NON-FERROUS
- PLASTICS/COMPOSITES

For patent information visit www.ksptpatents.com

4 Flute Double End Ball End

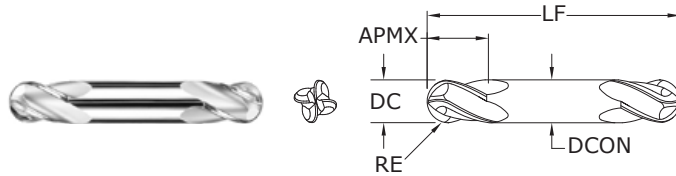
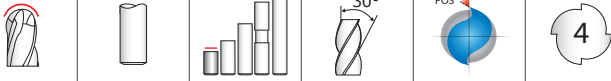

14B

FRACTIONAL SERIES

TOLERANCES (inch)

DC = +0.0000/-0.0020
 DCON = h₆
 RE = +0.0000/-0.0010

- STEELS
- STAINLESS STEELS
- CAST IRON
- HIGH TEMP ALLOYS
- TITANIUM
- HARDENED STEELS
- NON-FERROUS
- PLASTICS/COMPOSITES

For patent information visit www.ksptpatents.com

inch				EDP NO.			
CUTTING DIAMETER DC	LENGTH OF CUT APMX	OVERALL LENGTH LF	SHANK DIAMETER DCON	UNCOATED	Ti-NAMITE (TiN)	Ti-NAMITE-C (TiCN)	Ti-NAMITE-A (AlTiN)
1/32	1/16	1-1/2	1/8	31402	31442	39602	31218
3/64	3/32	1-1/2	1/8	31404	31444	39604	31219
1/16	1/8	1-1/2	1/8	31406	31446	39606	31220
5/64	1/8	1-1/2	1/8	31408	31448	39608	31221
3/32	3/16	1-1/2	1/8	31410	31450	39610	31222
7/64	3/16	1-1/2	1/8	31412	31452	39612	31223
*1/8	1/4	1-1/2	1/8	31414	31454	39614	31224
9/64	5/16	2	3/16	31416	31456	39616	31225
5/32	5/16	2	3/16	31418	31458	39618	31226
11/64	5/16	2	3/16	31420	31460	39620	31227
*3/16	3/8	2	3/16	31422	31462	39622	31228
13/64	1/2	2-1/2	1/4	31424	31464	39624	31229
7/32	1/2	2-1/2	1/4	31426	31466	39626	31230
15/64	1/2	2-1/2	1/4	31428	31468	39628	31231
*1/4	1/2	2-1/2	1/4	31430	31470	39630	31232
9/32	1/2	2-1/2	5/16	31432	31472	39632	31233
*5/16	1/2	2-1/2	5/16	31434	31474	39634	31234
*3/8	9/16	2-1/2	3/8	31436	31476	39636	31235
7/16	9/16	2-3/4	7/16	31438	31478	39638	31236
*1/2	5/8	3	1/2	31440	31480	39640	31237
				31490	31482	39642	31217

*Series 14B Set
 RE = 1/2 Cutting Diameter (DC)

TOLERANCES (mm)

DC = +0,000/-0,050
 DCON = h₆
 RE = +0,000/-0,025

14MB

METRIC SERIES

- STEELS
- STAINLESS STEELS
- CAST IRON
- HIGH TEMP ALLOYS
- TITANIUM
- HARDENED STEELS
- NON-FERROUS
- PLASTICS/COMPOSITES

For patent information visit www.ksptpatents.com

mm				EDP NO.			
CUTTING DIAMETER DC	LENGTH OF CUT APMX	OVERALL LENGTH LF	SHANK DIAMETER DCON	UNCOATED	Ti-NAMITE (TiN)	Ti-NAMITE-C (TiCN)	Ti-NAMITE-A (AlTiN)
1,0	2,0	38,0	3,0	41406	48947	48968	48989
1,5	3,0	38,0	3,0	41410	48948	48969	48990
2,0	4,0	38,0	3,0	41414	48949	48970	48991
2,5	5,0	38,0	3,0	41418	48950	48971	48992
3,0	6,0	38,0	3,0	41422	48951	48972	48993
3,5	7,0	50,0	4,0	41426	48952	48973	48994
4,0	8,0	50,0	4,0	41430	48953	48974	48995
4,5	9,5	63,0	4,5	41434	48954	48975	48996
5,0	10,0	63,0	5,0	41438	48955	48976	48997
6,0	12,0	63,0	6,0	41442	48956	48977	48998
7,0	12,0	63,0	8,0	41446	48957	48978	48999
8,0	12,0	63,0	8,0	41450	48958	48979	49000
9,0	14,0	75,0	9,0	41454	48959	48980	49001
10,0	14,0	75,0	10,0	41458	48960	48981	49002
11,0	14,0	75,0	12,0	41462	48961	48982	49003
12,0	16,0	75,0	12,0	41466	48962	48983	49004

RE = 1/2 Cutting Diameter (DC)

4 Flute Square End Stub



TOLERANCES (inch)

DC = -0.0000/-0.0020

DCON = h₆

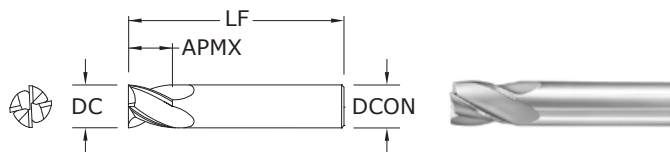

16
FRACTIONAL SERIES

inch				EDP NO.			
CUTTING DIAMETER DC	LENGTH OF CUT APMX	OVERALL LENGTH LF	SHANK DIAMETER DCON	UNCOATED	Ti-NAMITE (TiN)	Ti-NAMITE-C (TiCN)	Ti-NAMITE-A (AlTiN)
1/16	1/8	1-1/2	1/8	31601	31650	31238	31251
3/32	3/16	1-1/2	1/8	31603	31651	31239	31252
1/8	1/4	1-1/2	1/8	31605	31652	31240	31253
5/32	5/16	2	3/16	31607	31653	31241	31254
3/16	3/8	2	3/16	31609	31654	31242	31255
7/32	7/16	2	1/4	31611	31655	31243	31256
1/4	1/2	2	1/4	31613	31656	31244	31257
5/16	1/2	2	5/16	31615	31657	31245	31258
3/8	5/8	2	3/8	31617	31658	31246	31259
7/16	5/8	2-1/2	7/16	31619	31659	31247	31260
1/2	5/8	2-1/2	1/2	31621	31660	31248	31261
5/8	3/4	3	5/8	31623	31661	31249	31262
3/4	1	3	3/4	31625	31662	31250	31263

- STEELS
- STAINLESS STEELS
- CAST IRON
- HIGH TEMP ALLOYS
- TITANIUM
- HARDENED STEELS
- NON-FERROUS
- PLASTICS/COMPOSITES

For patent information visit www.ksptpatents.com

TOLERANCES (mm)

DC = +0,000/-0,050

DCON = h₆

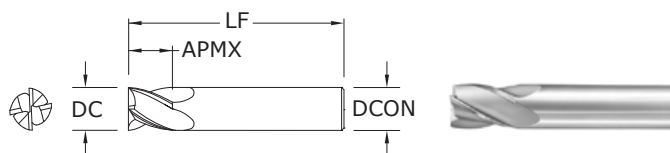

16M
METRIC SERIES

mm				EDP NO.			
CUTTING DIAMETER DC	LENGTH OF CUT APMX	OVERALL LENGTH LF	SHANK DIAMETER DCON	UNCOATED	Ti-NAMITE (TiN)	Ti-NAMITE-C (TiCN)	Ti-NAMITE-A (AlTiN)
1,0	2,0	38,0	3,0	41605	49136	49157	49178
1,5	3,0	38,0	3,0	41609	49137	49158	49179
2,0	4,0	38,0	3,0	41613	49138	49159	49180
2,5	5,0	38,0	3,0	41617	49139	49160	49181
3,0	6,0	38,0	3,0	41621	49140	49161	49182
3,5	7,0	50,0	4,0	41625	49141	49162	49183
4,0	8,0	50,0	4,0	41629	49142	49163	49184
4,5	9,5	50,0	4,5	41633	49143	49164	49185
5,0	10,0	50,0	5,0	41637	49144	49165	49186
6,0	12,0	50,0	6,0	41641	49145	49166	49187
7,0	12,0	50,0	8,0	41645	49146	49167	49188
8,0	12,0	50,0	8,0	41649	49147	49168	49189
9,0	14,0	50,0	9,0	41653	49148	49169	49190
10,0	16,0	50,0	10,0	41657	49149	49170	49191
11,0	19,0	63,0	12,0	41661	49150	49171	49192
12,0	19,0	63,0	12,0	40165	49151	49172	49193

- STEELS
- STAINLESS STEELS
- CAST IRON
- HIGH TEMP ALLOYS
- TITANIUM
- HARDENED STEELS
- NON-FERROUS
- PLASTICS/COMPOSITES

For patent information visit www.ksptpatents.com

4 Flute High Shear

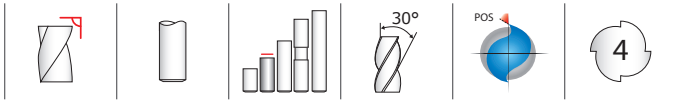

54 FRACTIONAL SERIES

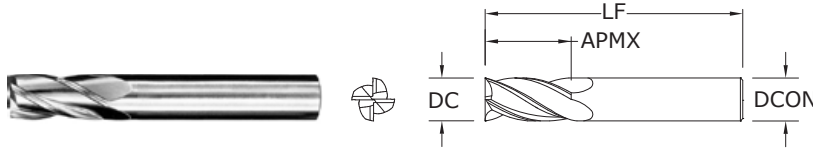

TOLERANCES (inch)

DC = +0.0000/-0.0020
DCON = h₆

- NON-FERROUS
- PLASTICS/COMPOSITES

For patent information visit www.ksptpatents.com

inch				EDP NO.	
CUTTING DIAMETER DC	LENGTH OF CUT APMX	OVERALL LENGTH LF	SHANK DIAMETER DCON	UNCOATED	Ti-NAMITE-C (TiCN)
1/16	3/16	1-1/2	1/8	35473	35500
3/32	3/8	1-1/2	1/8	35475	35501
1/8	7/16	1-1/2	1/8	35477	35502
5/32	9/16	2	3/16	35478	35503
3/16	9/16	2	3/16	35479	35504
7/32	5/8	2-1/2	1/4	35480	35505
1/4	3/4	2-1/2	1/4	35481	35506
9/32	3/4	2-1/2	5/16	35482	35507
5/16	13/16	2-1/2	5/16	35483	35508
3/8	7/8	2-1/2	3/8	35485	35509
7/16	1	2-3/4	7/16	35487	35510
1/2	1	3	1/2	35489	35511
9/16	1-1/8	3-1/2	9/16	35491	35512
5/8	1-1/4	3-1/2	5/8	35493	35513
3/4	1-1/2	4	3/4	35495	35514
1	1-1/2	4	1	35497	35515

54M METRIC SERIES

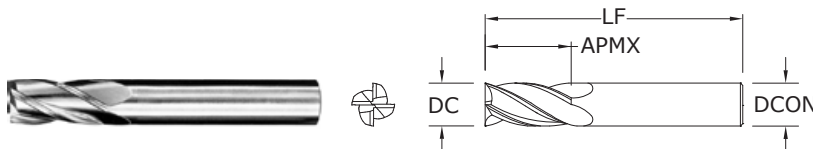

TOLERANCES (mm)

DC = +0,000/-0,050
DCON = h₆
RE = +0,000/-0,025

- NON-FERROUS
- PLASTICS/COMPOSITES

For patent information visit www.ksptpatents.com

mm				EDP NO.	
CUTTING DIAMETER DC	LENGTH OF CUT APMX	OVERALL LENGTH LF	SHANK DIAMETER DCON	UNCOATED	Ti-NAMITE-C (TiCN)
3,0	8,0	38,0	3,0	45477	45478
3,5	10,0	57,0	6,0	45479	45480
4,0	11,0	57,0	6,0	45481	45482
4,5	11,0	57,0	6,0	45483	45484
5,0	13,0	57,0	6,0	45485	45486
6,0	13,0	57,0	6,0	45487	45488
8,0	19,0	63,0	8,0	45489	45490
10,0	22,0	72,0	10,0	45491	45492
12,0	26,0	83,0	12,0	45493	45494
14,0	26,0	83,0	14,0	45495	45496
16,0	32,0	92,0	16,0	45497	45498
20,0	38,0	104,0	20,0	45499	45500

Single End Roughers (Coarse Pitch)

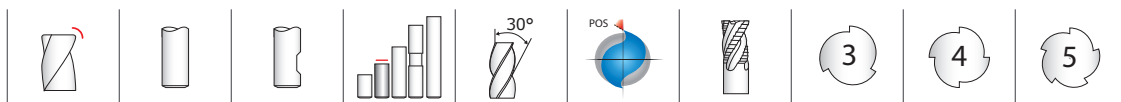

TOLERANCES (inch)

DC = +0.0000/-0.0040

DCON = h_6

RE = +0.0050/-0.0050

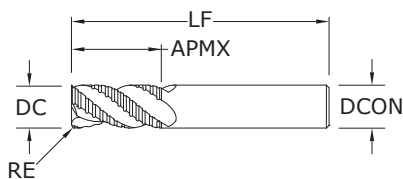

61
FRACTIONAL SERIES

inch						EDP NO.		
CUTTING DIAMETER DC	LENGTH OF CUT APMX	OVERALL LENGTH LF	SHANK DIAMETER DCON	CORNER RADIUS RE	NO. OF FLUTES	Ti-NAMITE (TiN)	Ti-NAMITE-C (TiCN)	Ti-NAMITE-A (AlTiN)
*1/4	3/4	2-1/2	1/4	.045	3	36107	36106	36110
*5/16	3/4	2-1/2	5/16	.045	3	36109	36108	36111
3/8	7/8	2-1/2	3/8	.060	3	36113	36112	36114
1/2	1	3	1/2	.060	4	36117	36116	36118
5/8	1-1/4	3-1/2	5/8	.060	4	36121	36120	36122
3/4	1-5/8	4	3/4	.060	4	36125	36124	36126
1	1-3/4	4	1	.060	5	36129	36128	36130

*Without Flat

- STEELS
- CAST IRON
- HARDENED STEELS

For patent information visit www.ksptpatents.com

TOLERANCES h10 (mm)

DC = +0,000 / -0,100

DCON = h_6

RE = +0,127/-0,127

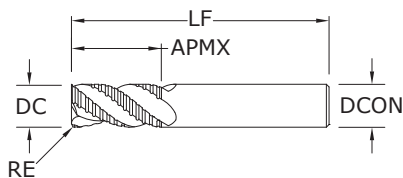

61M
METRIC SERIES

mm						EDP NO.		
CUTTING DIAMETER DC	LENGTH OF CUT APMX	OVERALL LENGTH LF	SHANK DIAMETER DCON	CORNER RADIUS RE	NO. OF FLUTES	Ti-NAMITE (TiN)	Ti-NAMITE-C (TiCN)	Ti-NAMITE-A (AlTiN)
6,0	19,0	63,0	6,0	1,14	3	46107	46106	46110
8,0	19,0	63,0	8,0	1,14	3	46109	46108	46111
10,0	22,0	72,0	10,0	1,52	3	46113	46112	46114
12,0	26,0	83,0	12,0	1,52	4	46117	46116	46118
16,0	32,0	92,0	16,0	1,52	4	46121	46120	46122
20,0	38,0	104,0	20,0	1,52	4	46129	46128	46132
25,0	44,0	104,0	25,0	1,52	5	46131	46130	46133

- STEELS
- CAST IRON
- HARDENED STEELS

For patent information visit www.ksptpatents.com

Single End Roughers (Fine Pitch)

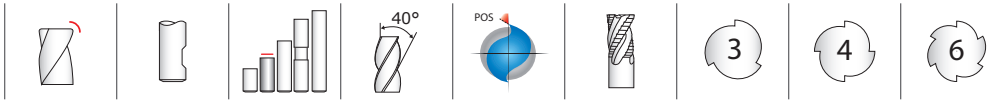

62
FRACTIONAL SERIES

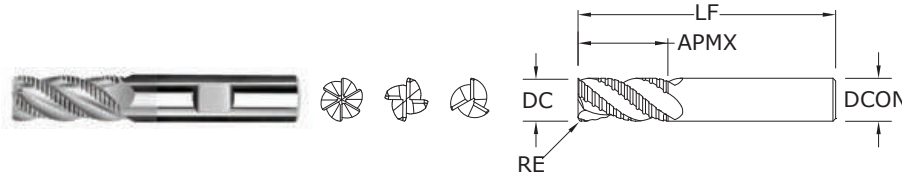

TOLERANCES (inch)

DC = +0.0000/-0.0040
 DCON = h_6
 RE = +0.0050/-0.0050

- STAINLESS STEELS
- HIGH TEMP ALLOYS
- TITANIUM

For patent information visit www.ksptpatents.com

CUTTING DIAMETER DC	LENGTH OF CUT APMX	inch				NO. OF FLUTES	EDP NO.		
		OVERALL LENGTH LF	SHANK DIAMETER DCON	CORNER RADIUS RE	Ti-NAMITE (TiN)		Ti-NAMITE-C (TiCN)	Ti-NAMITE-A (AlTiN)	
*1/4	3/4	2-1/2	1/4	.045	3	36207	36206	36210	
*5/16	3/4	2-1/2	5/16	.045	3	36209	36208	36211	
3/8	7/8	2-1/2	3/8	.060	3	36213	36212	36214	
1/2	1	3	1/2	.060	4	36217	36216	36218	
5/8	1-1/4	3-1/2	5/8	.060	4	36221	36220	36222	
3/4	1-5/8	4	3/4	.060	4	36225	36224	36226	
1	1-3/4	4	1	.060	6	36229	36228	36230	

*Without Flat

Single End Roughers (Fine Pitch)

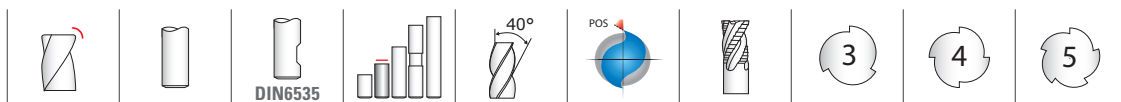

TOLERANCES h10 (mm)

DC = +0,000 / -0,100

DCON = h₆

RE = +0,127 / -0,127

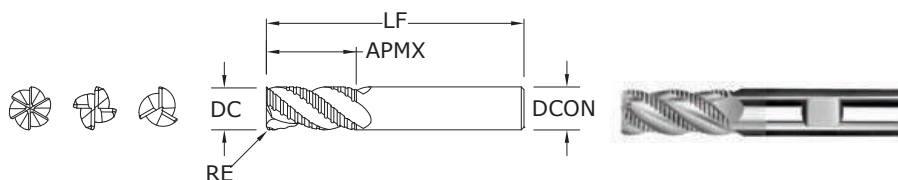

62M
METRIC SERIES

CUTTING DIAMETER DC	LENGTH OF CUT APMX	OVERALL LENGTH LF	mm			EDP NO.		
			SHANK DIAMETER DCON	CORNER RADIUS RE	NO. OF FLUTES	Ti-NAMITE (TiN)	Ti-NAMITE-C (TiCN)	Ti-NAMITE-A (AlTiN)
6,0	19,0	63,0	6,0	1,14	3	46207	46206	46210
8,0	19,0	63,0	8,0	1,14	3	46209	46208	46211
10,0	22,0	72,0	10,0	1,52	3	46213	46212	46214
12,0	26,0	83,0	12,0	1,52	4	46217	46216	46218
16,0	32,0	92,0	16,0	1,52	4	46221	46220	46222
20,0	38,0	104,0	20,0	1,52	4	46229	46228	46232
25,0	44,0	104,0	25,0	1,52	5	46231	46230	46233

STAINLESS STEELS

HIGH TEMP ALLOYS

TITANIUM

For patent information visit www.ksptpatents.com

End Mill Sets

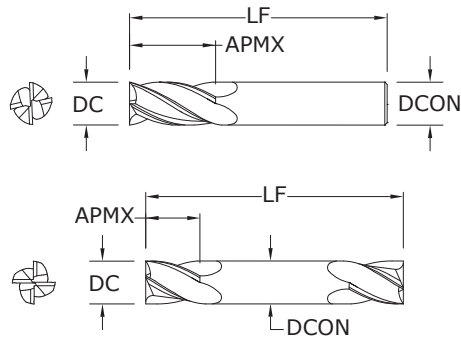

Pictured:
Series 1 4 Flute
Single End Square
Endmill Set

CUTTING DIAMETER DC	SINGLE END LENGTH OF CUT APMX	DOUBLE END LENGTH OF CUT APMX	OVERALL LENGTH LF	SHANK DIAMETER DCON
1/8	1/2	1/4	1-1/2	1/8
3/16	5/8	3/8	2	3/16
1/4	3/4	1/2	2-1/2	1/4
5/16	13/16	1/2	2-1/2	5/16
3/8	1	9/16	2-1/2	3/8
1/2	1	5/8	3	1/2

Square End

FRACTIONAL SERIES



For patent information visit
www.ksptpatents.com

DESCRIPTION	EDP NO.			
	UNCOATED	Ti-NAMITE (TiN)	Ti-NAMITE-C (TiCN)	Ti-NAMITE-A (AlTiN)
Series 1 – 4 Flute, Single End	30189	39189	39089	30030
Series 3 – 2 Flute, Single End	30389	39389	39589	30470
Series 5 – 3 Flute, Single End	30589	39789	30810	30850
Series 14 – 4 Flute, Double End	31489	31481	39641	31190
Series 15 – 2 Flute, Double End	31589	31581	39691	31336

FRACTIONAL End Mill Sets

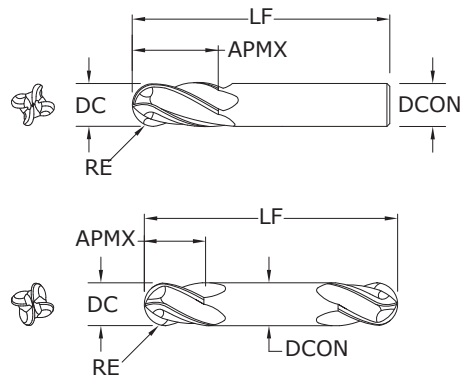

Pictured:
Series 1 4 Flute Single
End Ball Endmill Set

CUTTING DIAMETER DC	SINGLE END LENGTH OF CUT APMX	DOUBLE END LENGTH OF CUT APMX	OVERALL LENGTH LF	SHANK DIAMETER DCON
1/8	1/2	1/4	1-1/2	1/8
3/16	5/8	3/8	2	3/16
1/4	3/4	1/2	2-1/2	1/4
5/16	13/16	1/2	2-1/2	5/16
3/8	1	9/16	2-1/2	3/8
1/2	1	5/8	3	1/2

RE = 1/2 Cutting Diameter (DC)

Ball End FRACTIONAL SERIES

DESCRIPTION	EDP NO.			
	UNCOATED	Ti-NAMITE (TiN)	Ti-NAMITE-C (TiCN)	Ti-NAMITE-A (AlTiN)
Series 1B – 4 Flute, Single End	30190	39190	39090	30070
Series 3B – 2 Flute, Single End	30390	39390	39590	30600
Series 5B – 3 Flute, Single End	30590	30900	30944	31169
Series 14B – 4 Flute, Double End	31490	31482	39642	31217
Series 15B – 2 Flute, Double End	31590	31582	39692	31357







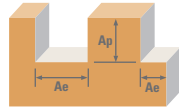

For patent
information visit
www.ksptpatents.com

2 Flute: Square & Ball End

4 Flute: Square & Ball End



Diamond 1, 1B, 3, 3B Fractional	Ae x DC	Ap x DC	Vc (sfm)	DC • in						
				1/8	1/4	5/16	3/8	1/2		
GRAPHITE Ultrafine, Superfine	Profile 	≤ 0.25	≤ 1.5	720	RPM	22003	11002	8801	7334	5501
				(576-864)	Fz	0.0009	0.0023	0.0036	0.0043	0.0058
					Feed 2 flutes (ipm)	38.3	50.6	63.4	63.1	63.8
					Feed 4 flutes (ipm)	76.6	101.2	126.7	126.2	127.6
					580	RPM	17725	8862	7090	5908
	Slot 	≤ 1	≤ 1	(464-696)	Fz	0.0075	0.0020	0.0031	0.0038	0.0050
					Feed 2 flutes (ipm)	265.9	35.4	44.0	44.9	44.3
					Feed 4 flutes (ipm)	531.7	70.9	87.9	89.8	88.6
	COMPOSITES FRP, CFRP, GRP	Profile 	≤ 0.25	≤ 1.5	385	RPM	11766	5883	4706	3922
(308-462)					Fz	0.0005	0.0014	0.0022	0.0026	0.0035
					Feed 2 flutes (ipm)	12.2	16.5	20.7	20.4	20.6
					Feed 4 flutes (ipm)	24.5	32.9	41.4	40.8	41.2
					350	RPM	10696	5348	4278	3565
Slot 		≤ 1	≤ 1	(280-420)	Fz	0.0005	0.0012	0.0019	0.0023	0.0030
					Feed 2 flutes (ipm)	9.6	12.8	16.3	16.4	16.0
					Feed 3 flutes (ipm)	19.3	25.7	32.5	32.8	32.1
PLASTICS Polycarbonate, PVC, Polypropylene		Profile 	≤ 0.25	≤ 1.5	1200	RPM	36672	18336	14669	12224
	(960-1440)				Fz	0.0009	0.0023	0.0036	0.0043	0.0058
					Feed 2 flutes (ipm)	63.8	84.3	105.6	105.1	106.3
					Feed 4 flutes (ipm)	127.6	168.7	211.2	210.3	212.7
					960	RPM	29338	14669	11735	9779
	Slot 	≤ 1	≤ 1	(768-1152)	Fz	0.0008	0.0020	0.0031	0.0038	0.0050
					Feed 2 flutes (ipm)	44.0	58.7	72.8	74.3	73.3
					Feed 3 flutes (ipm)	88.0	117.4	145.5	148.6	146.7

rpm = (Vc x 3.82) / DC
 ipm = Fz x number of flutes x rpm
 finish cuts typically require reduced feed and cut depths (.02 x D maximum)
 refer to the SGS Tool Wizard® for complete technical information (www.kyocera-sgstool.com)

FRACTIONAL

2 Flute: Square, Double, Stub, Long, Ball, Corner Radius
3 Flute: Square, Ball, Tapered
4 Flute: Square, Double, Stub, Ball, Corner Radius
Tapered: Square, Radius

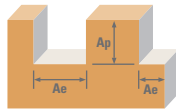

Series
 1, 3, 5, 14, 15, 16,
 17, 23, 24, 59
 Fractional

Series	Hardness	Flutes	Ae x DC	Ap x DC	Vc (sfm)	DC • in											
						1/64	1/32	1/16	1/8	1/4	3/8	1/2	3/4	1			
CARBON STEELS 1018, 1040, 1080, 1090, 10L50, 1140, 1212, 12L15, 1525, 1536	≤ 175 Bhn or ≤ 7 HRc	Profile	2	≤ 0.50	≤ 1.5	460	RPM	112461	56230	28115	14058	7029	4686	3514	2343	1757	
							Fz	0.00003	0.00006	0.00013	0.0003	0.0008	0.0015	0.0020	0.0024	0.0028	
							Feed (ipm)	6.7	6.7	7.3	8.4	11.2	14.1	14.1	11.2	9.8	
		Slot	2	1	≤ 1	335	RPM	81901	40950	20475	10238	5119	3413	2559	1706	1280	
							Fz	0.00003	0.00006	0.00013	0.0003	0.0008	0.0015	0.0020	0.0024	0.0028	
							Feed (ipm)	4.9	4.9	5.3	6.1	8.2	10.2	10.2	8.2	7.2	
	ALLOY STEELS 4140, 4150, 4320, 5120, 5150, 8630, 86L20, 50100	≤ 275 Bhn or ≤ 28 HRc	Profile	2	≤ 0.50	≤ 1.5	335	RPM	81901	40950	20475	10238	5119	3413	2559	1706	1280
								Fz	0.00002	0.00005	0.00009	0.0002	0.0006	0.0011	0.0015	0.0018	0.0021
								Feed (ipm)	3.3	4.1	3.7	4.1	6.1	7.5	7.7	6.1	5.4
			Slot	2	1	≤ 1	245	RPM	59898	29949	14974	7487	3744	2496	1872	1248	936
								Fz	0.00002	0.00005	0.00009	0.0002	0.0006	0.0011	0.0015	0.0018	0.0021
								Feed (ipm)	2.4	3.0	2.7	3.0	4.5	5.5	5.6	4.5	3.9
STAINLESS STEELS (FREE MACHINING) 303, 416, 420F, 430F 440F		≤ 275 Bhn or ≤ 28 HRc	Profile	2	≤ 0.50	≤ 1.5	370	RPM	90458	45229	22614	11307	5654	3769	2827	1885	1413
								Fz	0.00002	0.00005	0.00009	0.0002	0.0006	0.0011	0.0015	0.0018	0.0021
								Feed (ipm)	3.6	4.5	4.1	4.5	6.8	8.3	8.5	6.8	5.9
			Slot	2	1	≤ 1	270	RPM	66010	33005	16502	8251	4126	2750	2063	1375	1031
								Fz	0.00002	0.00005	0.00009	0.0002	0.0006	0.0011	0.0015	0.0018	0.0021
								Feed (ipm)	2.6	3.3	3.0	3.3	5.0	6.1	6.2	5.0	4.3
	STAINLESS STEELS (DIFFICULT) 304, 304L, 316, 316L, 17-4 PH, 15-5, 13-4, Custom 450	≤ 275 Bhn or ≤ 28 HRc	Profile	2	≤ 0.50	≤ 1.5	255	RPM	62342	31171	15586	7793	3896	2598	1948	1299	974
								Fz	0.00002	0.00004	0.00008	0.0002	0.0005	0.0009	0.0012	0.0014	0.0017
								Feed (ipm)	2.5	2.5	2.5	2.6	3.9	4.7	4.7	3.6	3.3
			Slot	2	1	≤ 1	185	RPM	45229	22614	11307	5654	2827	1885	1413	942	707
								Fz	0.00002	0.00004	0.00008	0.0002	0.0005	0.0009	0.0012	0.0014	0.0017
								Feed (ipm)	1.8	1.8	1.8	1.9	2.8	3.4	3.4	2.6	2.4
CAST IRONS Gray, Malleable, Ductile		≤ 220 Bhn or ≤ 19 HRc	Profile	2	≤ 0.50	≤ 1.5	335	RPM	81901	40950	20475	10238	5119	3413	2559	1706	1280
								Fz	0.00003	0.00006	0.00013	0.0003	0.0008	0.0015	0.0020	0.0024	0.0028
								Feed (ipm)	4.9	4.9	5.3	6.1	8.2	10.2	10.2	8.2	7.2
			Slot	2	1	≤ 1	245	RPM	59898	29949	14974	7487	3744	2496	1872	1248	936
								Fz	0.00003	0.00006	0.00013	0.0003	0.0008	0.0015	0.0020	0.0024	0.0028
								Feed (ipm)	3.6	3.6	3.9	4.5	6.0	7.5	7.5	6.0	5.2
	ALUMINUM ALLOYS 2017, 2024, 356, 6061, 7075	≤ 150 Bhn or ≤ 7 HRc	Profile	2	≤ 0.50	≤ 1.5	880	RPM	215142	107571	53786	26893	13446	8964	6723	4482	3362
								Fz	0.00006	0.00013	0.00025	0.0006	0.0016	0.0030	0.0040	0.0048	0.0056
								Feed (ipm)	25.8	28.0	26.9	32.3	43.0	53.8	53.8	43.0	37.6
			Slot	2	1	≤ 1	640	RPM	156467	78234	39117	19558	9779	6519	4890	3260	2445
								Fz	0.00006	0.00013	0.00025	0.0006	0.0016	0.0030	0.0040	0.0048	0.0056
								Feed (ipm)	18.8	20.3	19.6	23.5	31.3	39.1	39.1	31.3	27.4
COPPER ALLOYS Alum Bronze, C110, Muntz Brass		≤ 140 Bhn or ≤ 3 HRc	Profile	2	≤ 0.50	≤ 1.5	485	RPM	118573	59286	29643	14822	7411	4941	3705	2470	1853
								Fz	0.00003	0.00006	0.00013	0.0003	0.0008	0.0015	0.0020	0.0024	0.0028
								Feed (ipm)	7.1	7.1	7.7	8.9	11.9	14.8	14.8	11.9	10.4
			Slot	2	1	≤ 1	350	RPM	85568	42784	21392	10696	5348	3565	2674	1783	1337
								Fz	0.00003	0.00006	0.00013	0.0003	0.0008	0.0015	0.0020	0.0024	0.0028
								Feed (ipm)	5.1	5.1	5.6	6.4	8.6	10.7	10.7	8.6	7.5

continued on next page

FRACTIONAL

2 Flute: Square, Double, Stub, Long, Ball, Corner Radius

3 Flute: Square, Ball, Tapered

4 Flute: Square, Double, Stub, Ball, Corner Radius

Tapered: Square, Radius

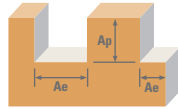

Series	Hardness	Flutes	Ae x DC	Ap x DC	Vc (sfm)	DC • in										
						1/64	1/32	1/16	1/8	1/4	3/8	1/2	3/4	1		
N	PLASTICS Polycarbonate, PVC, Polypropylene	Profile	2	≤ 0.50	≤ 1.5	880 RPM	Fz	215142	107571	53786	26893	13446	8964	6723	4482	3362
							Fz	0.00006	0.00013	0.00025	0.0006	0.0016	0.0030	0.0040	0.0048	0.0056
							Feed (ipm)	25.8	28.0	26.9	32.3	43.0	53.8	53.8	43.0	37.6
		Slot	3	≤ 0.25	≤ 1.5	640 RPM	Fz	156467	78234	39117	19558	9779	6519	4890	3260	2445
							Fz	0.00006	0.00013	0.00025	0.0006	0.0016	0.0030	0.0040	0.0048	0.0056
							Feed (ipm)	18.8	20.3	19.6	23.5	31.3	39.1	39.1	31.3	27.4
	GRAPHITE	Profile	2	≤ 0.50	≤ 1.5	660 RPM	Fz	161357	80678	40339	20170	10085	6723	5042	3362	2521
							Fz	0.00006	0.00013	0.00025	0.0006	0.0016	0.0030	0.0040	0.0048	0.0056
							Feed (ipm)	19.4	21.0	20.2	24.2	32.3	40.3	40.3	32.3	28.2
		Slot	3	≤ 0.25	≤ 1.5	480 RPM	Fz	117350	58675	29338	14669	7334	4890	3667	2445	1834
							Fz	0.00006	0.00013	0.00025	0.0006	0.0016	0.0030	0.0040	0.0048	0.0056
							Feed (ipm)	14.1	15.3	14.7	17.6	23.5	29.3	29.3	23.5	20.5
S	SUPER ALLOYS (NICKEL, COBALT, IRON BASE) Inconel 601, 617, 625, 718, Incoloy 800, Monel 400, Rene, Waspalloy	Profile	2	≤ 0.50	≤ 1.5	65 RPM	Fz	15891	7946	3973	1986	993	662	497	331	248
							Fz	0.00002	0.00003	0.00006	0.0002	0.0004	0.0008	0.0010	0.0012	0.0014
							Feed (ipm)	0.6	0.5	0.5	0.7	0.7	1.1	1.0	0.8	0.7
		Slot	3	≤ 0.25	≤ 1.5	45 RPM	Fz	11002	5501	2750	1375	688	458	344	229	172
							Fz	0.00002	0.00003	0.00006	0.0002	0.0004	0.0008	0.0010	0.0012	0.0014
							Feed (ipm)	0.4	0.3	0.3	0.5	0.5	0.7	0.7	0.6	0.5
	TITANIUM ALLOYS Ti6Al4V, Ti6Al2Sn4Zr2Mo, Ti4Al4Mo2Sn0.5Si, Ti10Al2Fe3Al, Ti5Al53Mo3Cr, Ti7Al4Mo, Ti3Al8V6Cr4Zr4Mo, Ti6Al6V6Sn, Ti152 Cr3Sn3Al	Profile	2	≤ 0.50	≤ 1.5	180 RPM	Fz	44006	22003	11002	5501	2750	1834	1375	917	688
							Fz	0.00002	0.00004	0.00008	0.0002	0.0005	0.0009	0.0012	0.0014	0.0017
							Feed (ipm)	1.8	1.8	1.8	2.2	2.8	3.3	3.3	2.6	2.3
		Slot	3	≤ 0.25	≤ 1.5	130 RPM	Fz	31782	15891	7946	3973	1986	1324	993	662	497
							Fz	0.00002	0.00004	0.00008	0.0002	0.0005	0.0009	0.0012	0.0014	0.0017
							Feed (ipm)	1.3	1.3	1.3	1.6	2.0	2.4	2.4	1.9	1.7
H	TOOL STEELS A2, D2, H13, L2, M2, P20, S7, T15, W2	Profile	2	≤ 0.50	≤ 1.5	315 RPM	Fz	77011	38506	19253	9626	4813	3209	2407	1604	1203
							Fz	0.00002	0.00005	0.00009	0.0002	0.0006	0.0011	0.0015	0.0018	0.0021
							Feed (ipm)	3.1	3.9	3.5	3.9	5.8	7.1	7.2	5.8	5.1
		Slot	3	≤ 0.25	≤ 1.5	230 RPM	Fz	56230	28115	14058	7029	3514	2343	1757	1171	879
							Fz	0.00002	0.00005	0.00009	0.0002	0.0006	0.0011	0.0015	0.0018	0.0021
							Feed (ipm)	2.2	2.8	2.5	2.8	4.2	5.2	5.3	4.2	3.7
	Slot	4	≤ 0.25	≤ 1.5	184-276 RPM	Fz	56230	28115	14058	7029	3514	2343	1757	1171	879	
						Fz	0.00002	0.00005	0.00009	0.0002	0.0006	0.0011	0.0015	0.0018	0.0021	
						Feed (ipm)	3.4	4.2	3.8	4.2	6.3	7.7	7.9	6.3	5.5	

Bhn (Brinell) HRc (Rockwell C)
 rpm = (Vc x 3.82) / DC
 ipm = Fz x number of flutes x rpm
 reduce speed and feed for materials harder than listed
 for tapered end mills, base the speed on the largest diameter contacting
 the workpiece and the feed on the smallest diameter
 limit cut depths of long and extra long flute mills to .05 x DC when slotting
 or profiling
 reduce feed and Ae when finish milling (.02 x DC maximum)
 refer to the SGS Tool Wizard® for complete technical information
 (www.kyocera-sgstool.com)

2 Flute: High Shear 4 Flute: High Shear

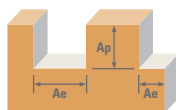

Series 52, 54 Fractional	Hardness	Flutes	Ae x DC	Ap x DC	Vc (sfm)	DC • in								
						1/8	1/4	3/8	1/2	3/4	1			
ALUMINUM ALLOYS 2024, 5052, 5086, 6061, 6063, 7075	≤ 150 Bhn or ≤ 7 HRc	Profile 	2	≤ 0.3	≤ 1.5	1360	RPM	41562	20781	13854	10390	6927	5195	
						(1088-1632)	Fz	0.00069	0.0018	0.0034	0.0046	0.0055	0.0064	
							Feed (ipm)	57.4	74.8	94.2	95.6	76.2	66.5	
		4	≤ 0.3	≤ 1.5	1090	RPM	33310	16655	11103	8328	5552	4164		
					(872-1308)	Fz	0.00063	0.0017	0.0032	0.0042	0.0050	0.0059		
						Feed (ipm)	42.0	56.6	71.1	70.0	55.5	49.1		
	Slot 	2	1	≤ 1	(328-492)	Fz	0.00063	0.0017	0.0032	0.0042	0.0050	0.0059		
													4	1
					31.6	42.6	53.5	52.6	41.8	37.0				
	ALUMINUM DIE CAST ALLOYS (HIGH SILICON) A-390, A-392, B-390	≤ 125 Bhn or ≤ 77 HRb	Profile 	2	≤ 0.3	≤ 1.5	510	RPM	15586	7793	5195	3896	2598	1948
							(408-612)	Fz	0.00069	0.0018	0.0034	0.0046	0.0055	0.0064
								Feed (ipm)	21.5	28.1	35.3	35.8	28.6	24.9
4			≤ 0.3	≤ 1.5	410	RPM	12530	6265	4177	3132	2088	1566		
					(328-492)	Fz	0.00063	0.0017	0.0032	0.0042	0.0050	0.0059		
						Feed (ipm)	15.8	21.3	26.7	26.3	20.9	18.5		
Slot 		2	1	≤ 1	(380-570)	Fz	0.00036	0.0010	0.0020	0.0026	0.0031	0.0037		
													4	1
					20.9	29.0	34.8	34.8	28.1	24.7				
COPPER ALLOYS Aluminum Bronze, Muntz Brass, Naval, Brass, Red Brass		≤ 140 Bhn or ≤ 3 HRc	Profile 	2	≤ 0.3	≤ 1.5	590	RPM	18030	9015	6010	4508	3005	2254
							(472-708)	Fz	0.00039	0.0010	0.0020	0.0026	0.0031	0.0037
								Feed (ipm)	14.1	18.0	24.0	23.4	18.6	16.7
	4		≤ 0.3	≤ 1.5	475	RPM	14516	7258	4839	3629	2419	1815		
					(380-570)	Fz	0.00036	0.0010	0.0018	0.0024	0.0029	0.0034		
						Feed (ipm)	10.5	14.5	17.4	17.4	14.0	12.3		
	Slot 	2	1	≤ 1	(188-282)	Fz	0.00039	0.0010	0.0020	0.0026	0.0031	0.0037		
													4	≤ 0.3
					11.2	14.4	19.2	18.7	14.8	13.3				
	COPPER ALLOYS Beryllium Copper, C110, Manganese Bronze, Tin Bronze	≤ 200 Bhn or ≤ 23 HRc	Profile 	2	≤ 0.3	≤ 1.5	235	RPM	7182	3591	2394	1795	1197	898
							(188-282)	Fz	0.00039	0.0010	0.0020	0.0026	0.0031	0.0037
								Feed (ipm)	5.6	7.2	9.6	9.3	7.4	6.6
4			≤ 0.3	≤ 1.5	190	RPM	5806	2903	1935	1452	968	726		
					(152-228)	Fz	0.00036	0.0010	0.0018	0.0024	0.0029	0.0034		
						Feed (ipm)	4.2	5.8	7.0	7.0	5.6	4.9		
Slot 		2	1	≤ 1	(1280-1920)	Fz	0.00110	0.0030	0.0056	0.0074	0.0089	0.0100		
													4	≤ 0.3
					215.1	293.4	365.1	361.8	290.1	244.5				
PLASTICS ABS, Polycarbonate, PVC, Polypropylene			Profile 	2	≤ 0.3	≤ 1.5	1600	RPM	48896	24448	16299	12224	8149	6112
							(1280-1920)	Fz	0.00110	0.0030	0.0056	0.0074	0.0089	0.0100
								Feed (ipm)	107.6	146.7	182.5	180.9	145.1	122.2
	4		≤ 0.3	≤ 1.5	1280	RPM	39117	19558	13039	9779	6519	4890		
					(1024-1536)	Fz	0.00100	0.0027	0.0051	0.0068	0.0082	0.0095		
						Feed (ipm)	78.2	105.6	133.0	133.0	106.9	92.9		
	Slot 	2	1	≤ 1	(576-864)	Fz	0.00082	0.0022	0.0041	0.0055	0.0065	0.0076		
													4	≤ 0.3
					72.2	96.8	120.3	121.0	95.3	83.6				
	PLASTICS Fiberglass, Glass Filled		Profile 	2	≤ 0.3	≤ 1.5	720	RPM	22003	11002	7334	5501	3667	2750
							(576-864)	Fz	0.00082	0.0022	0.0041	0.0055	0.0065	0.0076
								Feed (ipm)	36.1	48.4	60.1	60.5	47.7	41.8
4			≤ 0.3	≤ 1.5	575	RPM	17572	8786	5857	4393	2929	2197		
					(460-690)	Fz	0.00075	0.0020	0.0037	0.0050	0.0060	0.0070		
						Feed (ipm)	26.4	35.1	43.3	43.9	35.1	30.8		
Slot 		2	1	≤ 1	(460-690)	Fz	0.00075	0.0020	0.0037	0.0050	0.0060	0.0070		
													4	1
					52.7	70.3	86.7	87.9	70.3	61.5				

Bhn (Brinell) HRc (Rockwell C) HRb (Rockwell B)
 rpm = (Vc x 3.82) / DC
 ipm = Fz x number of flutes x rpm
 reduce speed and feed for materials harder than listed
 reduce feed and Ae when finish milling (.02 x DC maximum)
 refer to the SGS Tool Wizard® for complete technical information (www.kyocera-sgtool.com)

Single End Roughers (Coarse Pitch)

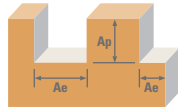



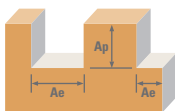

Series	Hardness	Ae x DC	Ap x DC	Vc (sfm)		DC • in					
						1/4	3/8	1/2	3/4	1	
61 Fractional P CARBON STEELS 1018, 1040, 1080, 1090, 10L50, 1140, 1212, 12L15, 1525, 1536 ALLOY STEELS 4140, 4150, 4320, 5120, 5150, 8630, 86L20, 50100	≤ 175 Bhn or ≤ 7 HRc	Profile 	≤ 0.5	≤ 1.5	500	RPM	7640	5093	3820	2547	1910
					(400-600)	Fz	0.0006	0.0011	0.0014	0.0017	0.0020
						Feed (ipm)	13.8	16.8	21.4	17.3	19.1
		Slot 	1	≤ 1	400	RPM	6112	4075	3056	2037	1528
					(320-480)	Fz	0.0006	0.0011	0.0014	0.0017	0.0020
						Feed (ipm)	11.0	13.4	17.1	13.9	15.3
	≤ 275 Bhn or ≤ 28 HR	Profile 	≤ 0.5	≤ 1.5	365	RPM	5577	3718	2789	1859	1394
					(292-438)	Fz	0.0004	0.0008	0.0011	0.0013	0.0015
						Feed (ipm)	6.7	8.9	12.3	9.7	10.5
		Slot 	1	≤ 1	295	RPM	4508	3005	2254	1503	1127
					(236-354)	Fz	0.0004	0.0008	0.0011	0.0013	0.0015
						Feed (ipm)	5.4	7.2	9.9	7.8	8.5
K CAST IRONS Gray, Malleable, Ductile	≤ 220 Bhn or ≤ 19 HRc	Profile 	≤ 0.5	≤ 1.5	365	RPM	5577	3718	2789	1859	1394
					(292-438)	Fz	0.0008	0.0015	0.0020	0.0024	0.0028
						Feed (ipm)	13.4	16.7	22.3	17.8	19.5
		Slot 	1	≤ 1	295	RPM	4508	3005	2254	1503	1127
					(236-354)	Fz	0.0008	0.0015	0.0020	0.0024	0.0028
						Feed (ipm)	10.8	13.5	18.0	14.4	15.8
H TOOL STEELS A2, D2, H13, L2, M2, P20, S7, T15, W2	≤ 250 Bhn or ≤ 24 HRc	Profile 	≤ 0.5	≤ 1.5	345	RPM	5272	3514	2636	1757	1318
					(276-414)	Fz	0.0006	0.0009	0.0015	0.0018	0.0021
						Feed (ipm)	9.5	9.5	15.8	12.7	13.8
		Slot 	1	≤ 1	275	RPM	4202	2801	2101	1401	1051
					(220-330)	Fz	0.0006	0.0009	0.0015	0.0018	0.0021
						Feed (ipm)	7.6	7.6	12.6	10.1	11.0

Bhn (Brinell) HRc (Rockwell C)
 $rpm = (Vc \times 3.82) / DC$
 $ipm = Fz \times \text{number of flutes} \times rpm$
 reduce speed and feed for materials harder than listed
 refer to the SGS Tool Wizard® for complete technical information (www.kyocera-sgstool.com)

Single End Roughers (Fine Pitch)



Series	62 Fractional	Hardness	Ae x DC	Ap x DC	Vc (sfm)	DC • in						
						1/4	3/8	1/2	3/4	1		
M	STAINLESS STEELS (FREE MACHINING) 303, 416, 420F, 430F, 440F	≤ 275 Bhn or ≤ 28 HRc	Profile 	≤ 0.5	≤ 1.5	405	RPM	6188	4126	3094	2063	1547
						(324-486)	Fz	0.0006	0.0011	0.0015	0.0019	0.0021
							Feed (ipm)	11.1	13.6	18.6	15.7	19.5
						325	RPM	4966	3311	2483	1655	1242
						(260-390)	Fz	0.0006	0.0011	0.0015	0.0019	0.0021
							Feed (ipm)	8.9	10.9	14.9	12.6	15.6
	STAINLESS STEELS (DIFFICULT) 304, 304L, 316, 316L, 17-4PH, 15-5PH, 13-4PH, Custom 450	≤ 275 Bhn or ≤ 28 HRc	Profile 	≤ 0.5	≤ 1.5	280	RPM	4278	2852	2139	1426	1070
						(224-336)	Fz	0.0005	0.0009	0.0012	0.0015	0.0017
							Feed (ipm)	6.4	7.7	10.3	8.6	10.9
						225	RPM	3438	2292	1719	1146	860
						(180-270)	Fz	0.0005	0.0009	0.0012	0.0015	0.0017
							Feed (ipm)	5.2	6.2	8.3	6.9	8.8
S	SUPER ALLOYS (NICKEL, COBALT, IRON BASE) Inconel 601, 617, 625, Incoloy 800, Monel 400, Rene, Waspalloy	≤ 300 Bhn or ≤ 32 HRc	Profile 	≤ 0.5	≤ 1.5	70	RPM	1070	713	535	357	267
						(56-84)	Fz	0.0004	0.0008	0.0010	0.0013	0.0014
							Feed (ipm)	1.3	1.7	2.1	1.9	2.2
						56	RPM	856	570	428	285	214
						(45-67)	Fz	0.0004	0.0008	0.0010	0.0013	0.0014
							Feed (ipm)	1.0	1.4	1.7	1.5	1.8
	TITANIUM ALLOYS Ti6Al4V, Ti6Al2Sn4Zr2Mo, Ti4Al4Mo2Sn0.5Si, Ti10Al2Fe3Al, Ti5Al3Mo3Cr, Ti7Al4Mo, Ti3Al8V6Cr4Zr4Mo, Ti6Al6V6Sn, Ti152 Cr3Sn3Al	≤ 350 Bhn or ≤ 38 HRc	Profile 	≤ 0.5	≤ 1.5	155	RPM	2368	1579	1184	789	592
						(124-186)	Fz	0.0005	0.0009	0.0012	0.0015	0.0017
							Feed (ipm)	3.6	4.3	5.7	4.7	6.0
						195	RPM	2980	1986	1490	993	745
						(156-234)	Fz	0.0005	0.0009	0.0012	0.0015	0.0017
							Feed (ipm)	4.5	5.4	7.2	6.0	7.6

Bhn (Brinell) HRc (Rockwell C)
 rpm = (Vc x 3.82) / DC
 ipm = Fz x number of flutes x rpm
 reduce speed and feed for materials harder than listed
 refer to the SGS Tool Wizard® for complete technical information (www.kyocera-sgstool.com)

METRIC

2 Flute: Square, Double, Stub, Long Reach, Ball

3 Flute: Square, Long Reach, Ball

4 Flute: Square, Double, Stub, Long Reach, Ball, Corner Radius

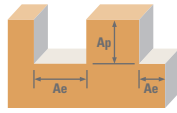

Series
1M, 3M, 5M,
14M, 15M, 16M,
17M, 59M
Metric

Series	Hardness	Flutes	Ae x DC	Ap x DC	Vc (m/min)	DC • mm											
						0.4	0.75	1.5	3	6	10	12	20	25			
P CARBON STEELS 1018, 1040, 1080, 1090, 10L50, 1140, 1212, 12L15, 1525, 1536	≤ 175 Bhn or ≤ 7 HRc	Profile	2	≤ 0.50	≤ 1.5	140	RPM	111483	59458	29729	14864	7432	4459	3716	2230	1784	
							Fz	0.0008	0.0015	0.0031	0.007	0.019	0.040	0.048	0.064	0.070	
							Feed (mm/min)	178	178	184	208	282	357	357	285	250	
		Slot	3	≤ 0.25	≤ 1.5	102	RPM	81189	43301	21650	10825	5413	3248	2706	1624	1299	
							Fz	0.0008	0.0015	0.0031	0.007	0.019	0.040	0.048	0.064	0.070	
							Feed (mm/min)	130	130	134	152	206	260	260	208	182	
	≤ 275 Bhn or ≤ 28 HRc	Profile	2	≤ 0.50	≤ 1.5	75	RPM	59377	31668	15834	7917	3958	2375	1979	1188	950	
							Fz	0.0005	0.0012	0.0022	0.006	0.014	0.029	0.036	0.048	0.052	
							Feed (mm/min)	81	104	95	130	152	188	195	156	135	
		Slot	3	≤ 0.25	≤ 1.5	82-123	RPM	81189	43301	21650	10825	5413	3248	2706	1624	1299	
							Fz	0.0005	0.0012	0.0022	0.006	0.014	0.029	0.036	0.048	0.052	
							Feed (mm/min)	122	156	143	195	227	283	292	234	203	
M STAINLESS STEELS (FREE MACHINING) 303, 416, 420F, 430F 440F	≤ 275 Bhn or ≤ 28 HRc	Profile	2	≤ 0.50	≤ 1.5	113	RPM	89671	47825	23912	11956	5978	3587	2989	1793	1435	
							Fz	0.0005	0.0012	0.0022	0.006	0.014	0.029	0.036	0.048	0.052	
							Feed (mm/min)	90	115	105	143	167	208	215	172	149	
		Slot	3	≤ 0.25	≤ 1.5	82	RPM	65436	34899	17449	8725	4362	2617	2181	1309	1047	
							Fz	0.0005	0.0012	0.0022	0.006	0.014	0.029	0.036	0.048	0.052	
							Feed (mm/min)	65	84	77	105	122	152	157	126	109	
	≤ 275 Bhn or ≤ 28 HRc	Profile	2	≤ 0.50	≤ 1.5	78	RPM	61800	32960	16480	8240	4120	2472	2060	1236	989	
							Fz	0.0005	0.0010	0.0019	0.004	0.012	0.024	0.029	0.037	0.042	
							Feed (mm/min)	62	66	63	66	99	119	119	91	83	
		Slot	3	≤ 0.25	≤ 1.5	56	RPM	44836	23912	11956	5978	2989	1793	1495	897	717	
							Fz	0.0005	0.0010	0.0019	0.004	0.012	0.024	0.029	0.037	0.042	
							Feed (mm/min)	93	99	94	99	148	178	179	137	125	
K CAST IRONS Gray, Malleable, Ductile	≤ 220 Bhn or ≤ 19 HRc	Profile	2	≤ 0.50	≤ 1.5	102	RPM	81189	43301	21650	10825	5413	3248	2706	1624	1299	
							Fz	0.0008	0.0015	0.0031	0.007	0.019	0.040	0.048	0.064	0.070	
							Feed (mm/min)	130	130	134	152	206	260	260	208	182	
		Slot	3	≤ 0.25	≤ 1.5	75	RPM	59377	31668	15834	7917	3958	2375	1979	1188	950	
							Fz	0.0008	0.0015	0.0031	0.007	0.019	0.040	0.048	0.064	0.070	
							Feed (mm/min)	95	95	98	111	150	190	190	152	133	
	N ALUMINUM ALLOYS 2017, 2024, 356, 6061, 7075	≤ 150 Bhn or ≤ 7 HRc	Profile	2	≤ 0.50	≤ 1.5	268	RPM	213272	113745	56872	28436	14218	8531	7109	4265	3412
								Fz	0.0015	0.0032	0.0060	0.014	0.038	0.080	0.096	0.128	0.140
								Feed (mm/min)	640	728	682	796	1081	1365	1365	1092	955
			Slot	3	≤ 0.25	≤ 1.5	195	RPM	155107	82724	41362	20681	10340	6204	5170	3102	2482
								Fz	0.0015	0.0032	0.0060	0.014	0.038	0.080	0.096	0.128	0.140
								Feed (mm/min)	465	529	496	579	786	993	993	794	695

continued on next page

2 Flute: Square, Double, Stub, Long Reach, Ball 3 Flute: Square, Long Reach, Ball 4 Flute: Square, Double, Stub, Long Reach, Ball, Corner Radius

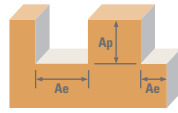

Series
1M, 3M, 5M,
14M, 15M, 16M,
17M, 59M
Metric

Series	Hardness	Flutes	Ae x DC	Ap x DC	Vc (m/min)	DC • mm										
						0.4	0.75	1.5	3	6	10	12	20	25		
COPPER ALLOYS Alum Bronze, C110, Muntz Brass	≤ 140 Bhn or ≤ 3 HRc	Profile	2 ≤ 0.50 ≤ 1.5	3 ≤ 0.25 ≤ 1.5	148	RPM	117542	62689	31344	15672	7836	4702	3918	2351	1881	
						Fz	0.0008	0.0015	0.0031	0.007	0.019	0.040	0.048	0.064	0.070	
						Feed (mm/min)	188	188	194	219	298	376	376	301	263	
							282	282	292	329	447	564	564	451	395	
							376	376	389	439	596	752	752	602	527	
						RPM	84824	45239	22620	11310	5655	3393	2827	1696	1357	
		Fz	0.0008	0.0015	0.0031	0.007	0.019	0.040	0.048	0.064	0.070					
		Slot	2 1 ≤ 1	3 1 ≤ 0.5	4 1 ≤ 0.4	148	RPM	136	136	140	158	215	271	271	217	190
							Fz	204	204	210	238	322	407	407	326	285
							Feed (mm/min)	271	271	280	317	430	543	543	434	380
								204	204	210	238	322	407	407	326	285
								271	271	280	317	430	543	543	434	380
RPM	213272						113745	56872	28436	14218	8531	7109	4265	3412		
Fz	0.0015	0.0032	0.0060	0.014	0.038	0.080	0.096	0.128	0.140							
PLASTICS Polycarbonate, PVC, Polypropylene		Profile	2 ≤ 0.50 ≤ 1.5	3 ≤ 0.25 ≤ 1.5	268	RPM	213272	113745	56872	28436	14218	8531	7109	4265	3412	
						Fz	0.0015	0.0032	0.0060	0.014	0.038	0.080	0.096	0.128	0.140	
						Feed (mm/min)	640	728	682	796	1081	1365	1365	1092	955	
							960	1092	1024	1194	1621	2047	2047	1638	1433	
							1280	1456	1365	1592	2161	2730	2730	2184	1911	
						RPM	155107	82724	41362	20681	10340	6204	5170	3102	2482	
		Fz	0.0015	0.0032	0.0060	0.014	0.038	0.080	0.096	0.128	0.140					
		Slot	2 1 ≤ 1	3 1 ≤ 0.5	4 1 ≤ 0.4	268	RPM	465	529	496	579	786	993	993	794	695
							Fz	698	794	745	869	1179	1489	1489	1191	1042
							Feed (mm/min)	931	1059	993	1158	1572	1985	1985	1588	1390
								698	794	745	869	1179	1489	1489	1191	1042
								931	1059	993	1158	1572	1985	1985	1588	1390
RPM	159954						85309	42654	21327	10664	6398	5332	3199	2559		
Fz	0.0015	0.0032	0.0060	0.014	0.038	0.080	0.096	0.128	0.140							
GRAPHITE		Profile	2 ≤ 0.50 ≤ 1.5	3 ≤ 0.25 ≤ 1.5	201	RPM	159954	85309	42654	21327	10664	6398	5332	3199	2559	
						Fz	0.0015	0.0032	0.0060	0.014	0.038	0.080	0.096	0.128	0.140	
						Feed (mm/min)	480	546	512	597	810	1024	1024	819	717	
							720	819	768	896	1216	1536	1536	1228	1075	
							960	1092	1024	1194	1621	2047	2047	1638	1433	
						RPM	116330	62043	31021	15511	7755	4653	3878	2327	1861	
		Fz	0.0015	0.0032	0.0060	0.014	0.038	0.080	0.096	0.128	0.140					
		Slot	2 1 ≤ 1	3 1 ≤ 0.5	4 1 ≤ 0.4	201	RPM	349	397	372	434	589	745	745	596	521
							Fz	523	596	558	651	884	1117	1117	893	782
							Feed (mm/min)	698	794	745	869	1179	1489	1489	1191	1042
								523	596	558	651	884	1117	1117	893	782
								698	794	745	869	1179	1489	1489	1191	1042
RPM	15753						8402	4201	2100	1050	630	525	315	252		
Fz	0.0005	0.0007	0.0014	0.004	0.010	0.021	0.024	0.032	0.035							
SUPER ALLOYS (NICKEL, COBALT, IRON BASE) Inconel 601, 617, 625, 718, Incoloy 800, Monel 400, Rene, Waspalloy	≤ 300 Bhn or ≤ 32 HRc	Profile	2 ≤ 0.50 ≤ 1.5	3 ≤ 0.25 ≤ 1.5	14	RPM	10906	5816	2908	1454	727	436	364	218	174	
						Fz	0.0005	0.0007	0.0014	0.004	0.010	0.021	0.024	0.032	0.035	
						Feed (mm/min)	11	8	8	12	15	18	17	14	12	
							16	12	12	17	22	27	26	21	18	
							22	16	16	23	29	37	35	28	24	
						RPM	43624	23266	11633	5816	2908	1745	1454	872	698	
		Fz	0.0005	0.0010	0.0019	0.004	0.012	0.024	0.029	0.037	0.042					
		Slot	2 1 ≤ 1	3 1 ≤ 0.5	4 1 ≤ 0.4	14	RPM	44	47	44	47	70	84	84	65	59
							Fz	65	70	66	70	105	126	127	97	88
							Feed (mm/min)	87	93	88	93	140	168	169	129	117
								65	70	66	70	105	126	127	97	88
								87	93	88	93	140	168	169	129	117
RPM	31506						16803	8402	4201	2100	1260	1050	630	504		
Fz	0.0005	0.0010	0.0019	0.004	0.012	0.024	0.029	0.037	0.042							
TOOL STEELS A2, D2, H13, L2, M2, P20, S7, T15, W2	≤ 250 Bhn or ≤ 24 HRc	Profile	2 ≤ 0.50 ≤ 1.5	3 ≤ 0.25 ≤ 1.5	96	RPM	76342	40715	20358	10179	5089	3054	2545	1527	1221	
						Fz	0.0005	0.0012	0.0022	0.006	0.014	0.029	0.036	0.048	0.052	
						Feed (mm/min)	76	98	90	122	143	177	183	147	127	
							115	147	134	183	214	266	275	220	191	
							153	195	179	244	285	354	366	293	254	
						RPM	55741	29729	14864	7432	3716	2230	1858	1115	892	
		Fz	0.0005	0.0012	0.0022	0.006	0.014	0.029	0.036	0.048	0.052					
		Slot	2 1 ≤ 1	3 1 ≤ 0.5	4 1 ≤ 0.4	96	RPM	56	71	65	89	104	129	134	107	93
							Fz	84	107	98	134	156	194	201	161	139
							Feed (mm/min)	111	143	131	178	208	259	268	214	186
								56	71	65	89	104	129	134	107	93
								84	107	98	134	156	194	201	161	139
RPM	55741						29729	14864	7432	3716	2230	1858	1115	892		
Fz	0.0005	0.0012	0.0022	0.006	0.014	0.029	0.036	0.048	0.052							

Bhn (Brinell) HRc (Rockwell C)
rpm = (Vc x 1000) / (DC x 3.14)
mm/min = Fz x number of flutes x rpm
reduce speed and feed for materials harder than listed

limit cut depths of long and extra long flute mills to .05 x DC when slotting or profiling
reduce feed and Ae when finish milling (.02 x DC maximum)
refer to the SGS Tool Wizard® for complete technical information
(www.kyocera-sgstoool.com)

2 Flute: High Shear 4 Flute: High Shear

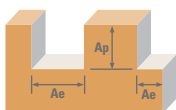

Series 52M, 54M Metric	Hardness	Flutes	Ae x DC	Ap x DC	Vc (m/min)	DC • mm									
						3	6	10	12	20	25				
ALUMINUM ALLOYS 2024, 5052, 5086, 6061, 6063, 7075	≤ 150 Bhn or ≤ 7 HRc	Profile 	2	≤ 0.3	≤ 1.5	415	RPM	43947	21973	13184	10987	6592	5274		
						(332-497)	Fz	0.0166	0.043	0.091	0.110	0.147	0.160		
		4	≤ 0.3	≤ 1.5	332	RPM	35222	17611	10567	8806	5283	4227			
						Feed (mm/min)	1459	1890	2399	2417	1938	1688			
		Slot 	2	1	≤ 1	(266-399)	Fz	0.0151	0.041	0.085	0.101	0.133	0.148		
							4	1	≤ 0.25	Feed (mm/min)	1064	1444	1796	1779	1405
		4	1	≤ 0.25	125	RPM	13249	6624	3975	3312	1987	1590			
						Fz	0.0151	0.041	0.085	0.101	0.133	0.148			
		ALUMINUM DIE CAST ALLOYS (HIGH SILICON) A-390, A-392, B-390	≤ 125 Bhn or ≤ 77 HRb	Profile 	2	≤ 0.3	≤ 1.5	155	RPM	16480	8240	4944	4120	2472	1978
								(124-187)	Fz	0.0166	0.043	0.091	0.110	0.147	0.160
4	≤ 0.3			≤ 1.5	125	RPM	13249	6624	3975	3312	1987	1590			
						Feed (mm/min)	547	709	900	906	727	633			
Slot 	2			1	≤ 1	(100-150)	Fz	0.0151	0.041	0.085	0.101	0.133	0.148		
							4	1	≤ 0.25	Feed (mm/min)	400	543	676	669	529
4	1			≤ 0.25	180	RPM	19065	9533	5720	4766	2860	2288			
						Fz	0.0094	0.024	0.053	0.062	0.083	0.093			
COPPER ALLOYS Aluminum Bronze, Muntz Brass, Naval, Brass, Red Brass	≤ 140 Bhn or ≤ 3 HRc			Profile 	2	≤ 0.3	≤ 1.5	180	RPM	19065	9533	5720	4766	2860	2288
								(144-216)	Fz	0.0094	0.024	0.053	0.062	0.083	0.093
		4	≤ 0.3	≤ 1.5	145	RPM	15349	7675	4605	3837	2302	1842			
						Feed (mm/min)	358	458	606	591	475	426			
		Slot 	2	1	≤ 1	(116-174)	Fz	0.0086	0.024	0.048	0.058	0.077	0.085		
							4	1	≤ 0.25	Feed (mm/min)	264	368	442	445	355
		4	1	≤ 0.25	72	RPM	7594	3797	2278	1898	1139	911			
						Fz	0.0094	0.024	0.053	0.062	0.083	0.093			
		COPPER ALLOYS Beryllium Copper, C110, Manganese Bronze, Tin Bronze	≤ 200 Bhn or ≤ 23 HRc	Profile 	2	≤ 0.3	≤ 1.5	72	RPM	7594	3797	2278	1898	1139	911
								(57-86)	Fz	0.0094	0.024	0.053	0.062	0.083	0.093
4	≤ 0.3			≤ 1.5	58	RPM	6140	3070	1842	1535	921	737			
						Feed (mm/min)	143	182	241	235	189	169			
Slot 	2			1	≤ 1	(46-69)	Fz	0.0086	0.024	0.048	0.058	0.077	0.085		
							4	1	≤ 0.25	Feed (mm/min)	106	147	177	178	142
4	1			≤ 0.25	211	RPM	295	354	356	284	250				
						Fz	0.0086	0.024	0.048	0.058	0.077	0.085			

continued on next page

2 Flute: High Shear 4 Flute: High Shear

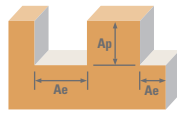



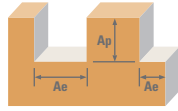

Series 52M, 54M Metric	Hardness	Flutes	Ae x DC	Ap x DC	Vc (m/min)	DC • mm								
						3	6	10	12	20	25			
PLASTICS ABS, Polycarbonate, PVC, Polypropylene	Profile	2	≤ 0.3	≤ 1.5	488	RPM	51702	25851	15511	12926	7755	6204		
					Fz	0.0264	0.072	0.149	0.178	0.237	0.250			
		4	≤ 0.3	≤ 1.5	(390-585)	Feed	2730	3723	4622	4601	3676	3102		
					(mm/min)	5460	7445	9244	9203	7352	6204			
		Slot	2	1	≤ 1	390	RPM	41362	20681	12409	10340	6204	4963	
						Fz	0.0240	0.065	0.136	0.163	0.210	0.238		
	4		1	≤ 0.25	(312-468)	Feed	1985	2689	3375	3371	2606	2363		
					(mm/min)	3971	5377	6750	6742	5212	4725			
	PLASTICS Fiberglass, Glass Filled		Profile	2	≤ 0.3	≤ 1.5	219	RPM	23266	11633	6980	5816	3490	2792
							Fz	0.0197	0.053	0.109	0.132	0.173	0.190	
		4		≤ 0.3	≤ 1.5	(176-263)	Feed	917	1233	1522	1536	1208	1061	
						(mm/min)	1833	2466	3043	3071	2415	2122		
Slot		2		1	≤ 1	175	RPM	18580	9290	5574	4645	2787	2230	
						Fz	0.0180	0.048	0.101	0.120	0.160	0.175		
		4	1	≤ 0.25	(140-210)	Feed	669	892	1126	1115	892	780		
					(mm/min)	1338	1784	2252	2230	1784	1561			

Bhn (Brinell) HRc (Rockwell C) HRb (Rockwell B)
 rpm = (Vc x 1000) / (DC x 3.14)
 mm/min = Fz x number of flutes x rpm
 reduce speed and feed for materials harder than listed
 reduce feed and Ae when finish milling (.02 x DC maximum)
 refer to the SGS Tool Wizard® for complete technical information (www.kyocera-sgstoool.com)

Single End Roughers (Coarse Pitch)









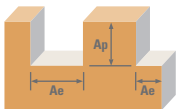

Series 61M Metric	Hardness	Ae x DC	Ap x DC	Vc (m/min)	DC • mm							
					6	10	12	20	25			
P CARBON STEELS 1018, 1040, 1080, 1090, 10L50, 1140, 1212, 12L15, 1525, 1536	≤ 175 Bhn or ≤ 7 HRc	Profile 	≤ 0.5	≤ 1.5	152	RPM	8078	4847	4039	2424	1939	
					(122-183)	Fz	0.014	0.029	0.034	0.045	0.050	
						Feed (mm/min)	339	422	549	436	485	
					122	RPM	6463	3878	3231	1939	1551	
					(98-146)	Fz	0.014	0.029	0.034	0.045	0.050	
						Feed (mm/min)	271	337	439	349	388	
	ALLOY STEELS 4140, 4150, 4320, 5120, 5150, 8630, 86L20, 50100	≤ 275 Bhn or ≤ 28 HR	Profile 	≤ 0.5	≤ 1.5	111	RPM	5897	3538	2949	1769	1415
						(89-134)	Fz	0.010	0.021	0.026	0.035	0.038
							Feed (mm/min)	177	223	307	248	269
						90	RPM	4766	2860	2383	1430	1144
						(72-108)	Fz	0.010	0.021	0.026	0.035	0.038
							Feed (mm/min)	143	180	248	200	217
K CAST IRONS Gray, Malleable, Ductile	≤ 220 Bhn or ≤ 19 HRc	Profile 	≤ 0.5	≤ 1.5	111	RPM	5897	3538	2949	1769	1415	
					(89-134)	Fz	0.019	0.040	0.048	0.064	0.070	
						Feed (mm/min)	336	425	566	453	495	
					90	RPM	4766	2860	2383	1430	1144	
					(72-108)	Fz	0.019	0.040	0.048	0.064	0.070	
						Feed (mm/min)	272	343	458	366	400	
H TOOL STEELS A2, D2, H13, L2, M2, P20, S7, T15, W2	≤ 250 Bhn or ≤ 24 HRc	Profile 	≤ 0.5	≤ 1.5	105	RPM	5574	3344	2787	1672	1338	
					(84-126)	Fz	0.014	0.024	0.036	0.048	0.053	
						Feed (mm/min)	234	241	401	321	355	
					84	RPM	4443	2666	2222	1333	1066	
					(67-101)	Fz	0.014	0.024	0.036	0.048	0.053	
						Feed (mm/min)	187	192	320	256	283	

Bhn (Brinell) HRc (Rockwell C)
 rpm = (Vc x 1000) / (DC x 3.14)
 mm/min = Fz x number of flutes x rpm
 reduce speed and feed for materials harder than listed
 refer to the SGS Tool Wizard® for complete technical information (www.kyocera-sgstool.com)

Single End Roughers (Fine Pitch)



Series 62M Metric	Hardness	Ae x DC	Ap x DC	Vc (m/min)	DC • mm							
					6	10	12	20	25			
M	STAINLESS STEELS (FREE MACHINING) 303, 416, 420F, 430F, 440F	≤ 275 Bhn or ≤ 28 HRc	Profile 	≤ 0.5	≤ 1.5	123	RPM	6544	3926	3272	1963	1570
						(99-148)	Fz	0.014	0.029	0.036	0.051	0.053
						Feed (mm/min)	283	345	471	398	495	
			Slot 	1	≤ 1	99	RPM	5251	3151	2626	1575	1260
						(79-119)	Fz	0.014	0.029	0.036	0.051	0.053
						Feed (mm/min)	227	277	378	319	397	
	STAINLESS STEELS (DIFFICULT) 304, 304L, 316, 316L, 17-4PH, 15-5PH, 13-4PH, Custom 450	≤ 275 Bhn or ≤ 28 HRc	Profile 	≤ 0.5	≤ 1.5	85	RPM	4524	2714	2262	1357	1086
						(68-102)	Fz	0.012	0.024	0.029	0.040	0.043
						Feed (mm/min)	163	195	261	217	277	
			Slot 	1	≤ 1	69	RPM	3635	2181	1818	1091	872
						(55-82)	Fz	0.012	0.024	0.029	0.040	0.043
						Feed (mm/min)	131	157	209	174	222	
S	SUPER ALLOYS (NICKEL, COBALT, IRON BASE) Inconel 601, 617, 625, Incoloy 800, Monel 400, Rene, Waspalloy	≤ 300 Bhn or ≤ 32 HRc	Profile 	≤ 0.5	≤ 1.5	21	RPM	1131	679	565	339	271
						(17-26)	Fz	0.010	0.021	0.024	0.035	0.035
						Feed (mm/min)	33	43	54	47	57	
			Slot 	1	≤ 1	17	RPM	905	543	452	271	217
						(14-20)	Fz	0.010	0.021	0.024	0.035	0.035
						Feed (mm/min)	26	35	43	38	46	
	TITANIUM ALLOYS Ti6Al4V, Ti6Al2Sn4Zr2Mo, Ti4Al4Mo2Sn0.5Si, Ti10Al2Fe3Al, Ti5Al53Mo3Cr, Ti7Al4Mo, Ti3Al8V6Cr4Zr4Mo, Ti6Al6V6Sn, Ti152 Cr3Sn3Al	≤ 350 Bhn or ≤ 38 HRc	Profile 	≤ 0.5	≤ 1.5	47	RPM	2504	1503	1252	751	601
						(38-57)	Fz	0.012	0.024	0.029	0.040	0.043
						Feed (mm/min)	90	108	144	120	153	
			Slot 	1	≤ 1	59	RPM	3151	1890	1575	945	756
						(48-71)	Fz	0.012	0.024	0.029	0.040	0.043
						Feed (mm/min)	113	136	181	151	193	

Bhn (Brinell) HRc (Rockwell C)
 rpm = (Vc x 1000) / (DC x 3.14)
 mm/min = Fz x number of flutes x rpm
 reduce speed and feed for materials harder than listed
 refer to the SGS Tool Wizard® for complete technical information (www.kyocera-sgstool.com)

High Performance Drills



Hole Making

HIGH PERFORMANCE DRILLS	SERIES	DESCRIPTION	APPLICATION		PAGE				
			● PREFERRED	○ ALTERNATE					
Hi-PerCarb®	135 (3xD)	2 Flute External Coolant Double Margin 3xD	●	●	●	●	●	○	231
	135 (5xD)	2 Flute External Coolant Double Margin 5xD	●	●	●	●	●	○	240
	131N (3xD)	3 Flute External Coolant Triple Margin 3xD						●	250
	131N (5xD)	3 Flute External Coolant Triple Margin 5xD						●	254
	141K (5xD)	3 Flute Internal Coolant Triple Margin 5xD			●				260
Ice-Carb®	140 (5xD)	2 Flute Internal Coolant 5xD	●	●	●	●	●	○	266
	140 (8xD)	2 Flute Internal Coolant 8xD	●	●	●	●	●	○	274
CFRP 8 Facet	120	2 Flute External Coolant Double Margin CFRP						●	282

Speed & Feed Recommendations listed after each series

Taladrado

BROCAS DE ALTO RENDIMIENTO	SERIE	DESCRIPCIÓN	APPLICATION		PÁGINA				
			● PREFERRED	○ ALTERNATE					
Hi-PerCarb®	135 (3xD)	2 filos, refrigeración externa, doble margen, 3xD	●	●	●	●	●	○	231
	135 (5xD)	2 filos, refrigeración externa, doble margen, 5xD	●	●	●	●	●	○	240
	131N (3xD)	3 filos, refrigeración externa, triple margen, 3xD						●	250
	131N (5xD)	3 filos, refrigeración externa, triple margen, 5xD						●	254
	141K (5xD)	3 filos, refrigeración interna, triple margen, 5xD			●				260
Ice-Carb®	140 (5xD)	2 filos, refrigeración interna, 5xD	●	●	●	●	●	○	266
	140 (8xD)	2 filos, refrigeración interna, 8xD	●	●	●	●	●	○	274
De 8 caras CFRP	120	2 filos, refrigeración externa, doble margen, CFRP						●	282

Recomendaciones de velocidades y avances mostradas tras cada serie

Outils de perçage

FORETS HAUTE PERFORMANCE	SÉRIES	DESCRIPTION	APPLICATION		PAGE				
			● PREFERRED	○ ALTERNATE					
Hi-PerCarb®	135 (3xD)	2 dents refroidissement externe à double listel 3xD	●	●	●	●	●	○	231
	135 (5xD)	2 dents refroidissement externe à double listel 5xD	●	●	●	●	●	○	240
	131N (3xD)	3 dents refroidissement externe à triple listel 3xD						●	250
	131N (5xD)	3 dents refroidissement externe à triple listel 5xD						●	254
	141K (5xD)	3 dents refroidissement interne à triple listel 5xD			●				260
Ice-Carb®	140 (5xD)	2 dents refroidissement interne 5xD	●	●	●	●	●	○	266
	140 (8xD)	2 dents refroidissement interne 8xD	●	●	●	●	●	○	274
CFRP à 8 facettes	120	2 dents refroidissement externe à double listel CFRP						●	282

Recommandations de vitesse et avance indiquées après chaque série

Bohren

HOCHLEISTUNGS-BOHRER	SERIE	BESCHREIBUNG	APPLICATION		SEITE				
			● PREFERRED	○ ALTERNATE					
Hi-PerCarb®	135 (3xD)	Doppelfasenbohrer 3xD mit 2 Schneiden und Außenkühlung	●	●	●	●	●	○	231
	135 (5xD)	Doppelfasenbohrer 5xD mit 2 Schneiden und Außenkühlung	●	●	●	●	●	○	240
	131N (3xD)	Dreifasenbohrer 3xD mit 3 Schneiden und Außenkühlung						●	250
	131N (5xD)	Dreifasenbohrer 5xD mit 3 Schneiden und Außenkühlung						●	254
	141K (5xD)	Dreifasenbohrer 5xD mit 3 Schneiden und Innenkühlung			●				260
Ice-Carb®	140 (5xD)	Bohrer 5xD mit 2 Schneiden und Innenkühlung	●	●	●	●	●	○	266
	140 (8xD)	Bohrer 8xD mit 2 Schneiden und Innenkühlung	●	●	●	●	●	○	274
CFRP 8 Facet	120	Doppelfasenbohrer CFRP mit 2 Schneiden und Außenkühlung						●	282

Empfehlungen für Drehzahl & Vorschub im Anhang zu jeder Serie

Drilling Operations Coolant Recommendations

- Coolant works to mobilize chips away from the cut zone, reduce the heat created during the cutting process and minimize friction.
- It is important to optimize the coolant pressure and position in order to gain the full benefits coolant offers the cutting process.
- Proper coolant application promotes greater operating parameters, greater material removal rates, improved surface finishes, predictable tool life, reduced power consumption and reduced cycle times.
- Pressure is important, but more importantly is consistency of the pressure and application onto the tool; intermittent cooling of carbide leads to thermal stressing of the material and the formation of “microcracks.”
- Proper cleanliness and filtration of coolants is important in order for the coolant to maintain its beneficial properties, and also to avoid a reduction in coolant pressure or the possibility of clogging the coolant channels in coolant through drills.

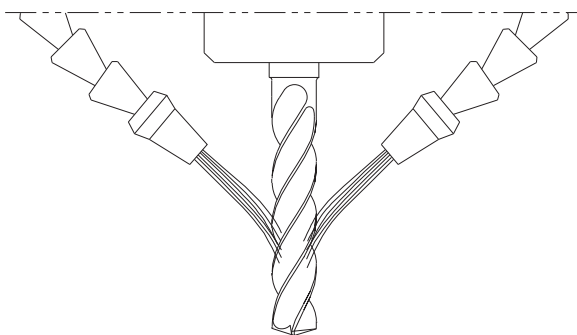
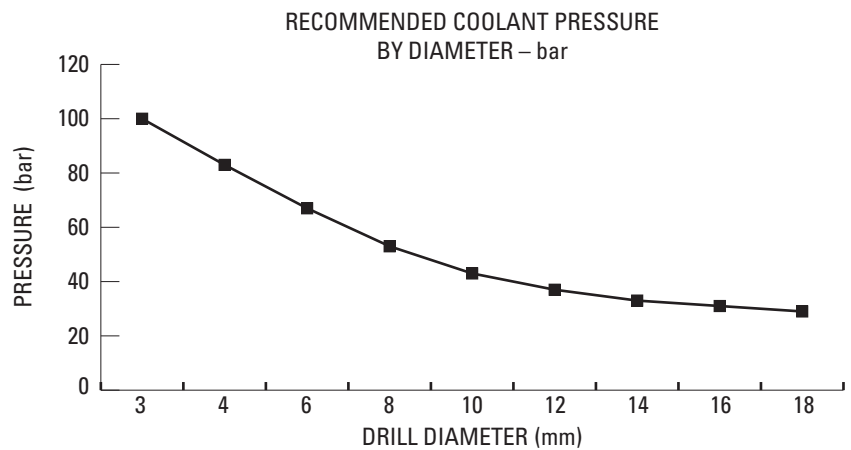
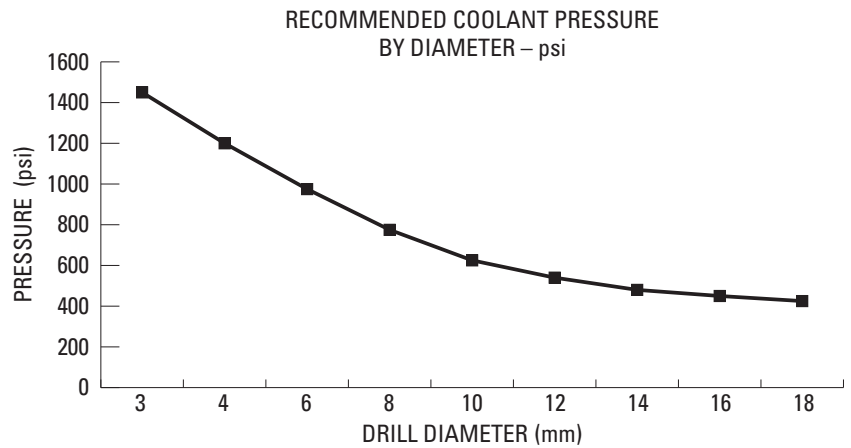

LARGE TIP – LOW VELOCITY
NO COVERAGE AT MAXIMUM DEPTH

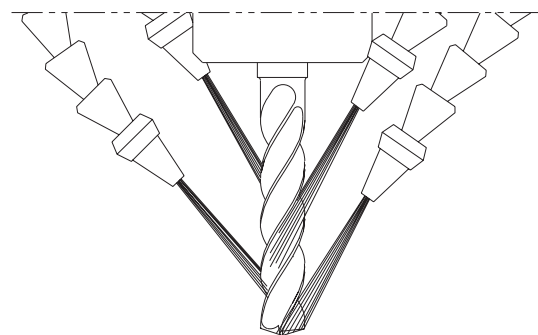

SMALL TIP – HIGH VELOCITY
COMPLETE COVERAGE

- Reducing the nozzle size helps maximize the cooling benefits of the unique double margin design on the Hi-PerCarb drill by increasing velocity. Aim the nozzles in line with the secondary flute located between the two margins as well as the flute for best results.

Recomendaciones en operación de taladrado

- El líquido de refrigeración actúa movilizándolo fuera de la zona de corte, disminuyendo el calor generado durante el proceso de corte y minimizando la fricción.
- Es importante optimizar la presión de la refrigeración y la posición para poder obtener todos los beneficios del refrigerante durante el proceso de corte.
- Una aplicación apropiada de la refrigeración fomenta mayores parámetros de operación, mayores índices de eliminación de material, acabados de superficie mejorados, una duración de la herramienta más predecible, bajo consumo de energía y un tiempo de ciclo reducido.
- La presión del refrigerante es importante, pero lo es más el flujo continuo aplicado a la herramienta; una refrigeración intermitente en el carburo puede ocasionar un estrés térmico en el material y la formación de "micro-fisuras".
- Una limpieza y filtración adecuadas son importantes para que el refrigerante mantenga sus propiedades y beneficios; por otra parte, se evita la reducción de la presión o la posibilidad de obstruir los canales de refrigeración de la broca.

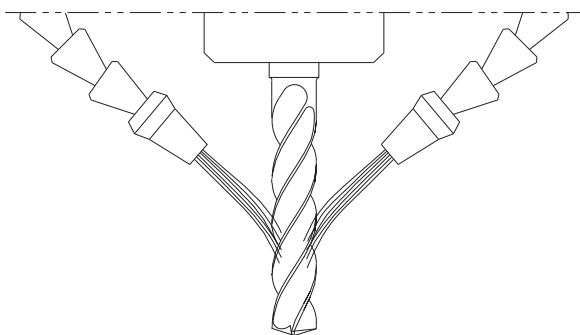
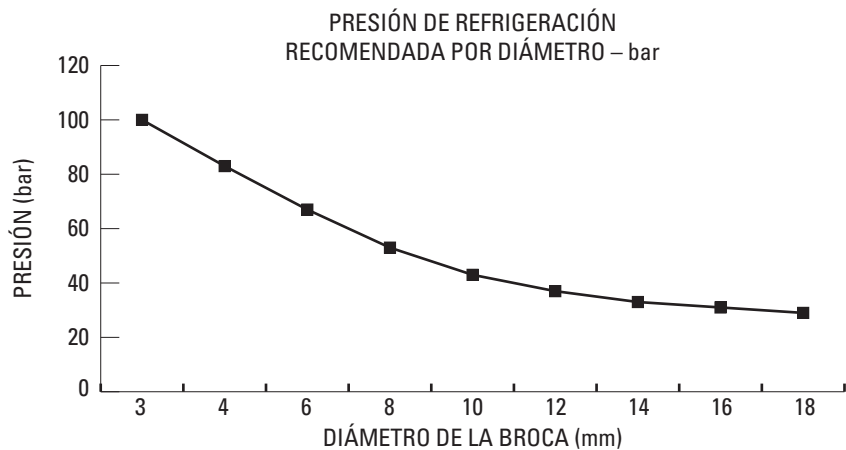
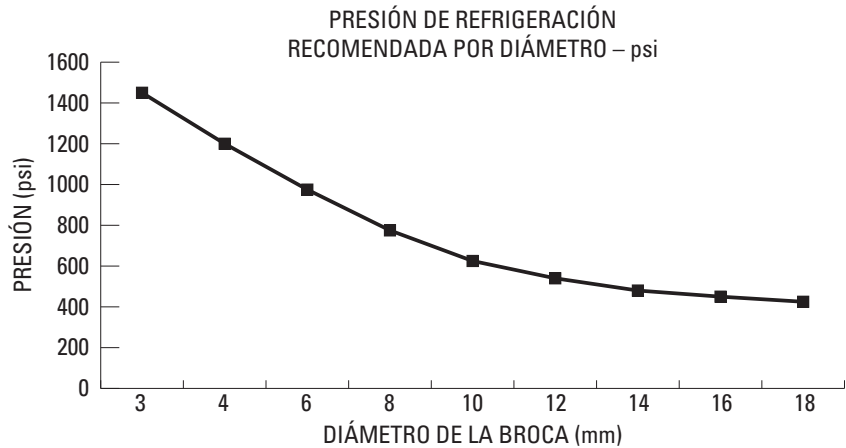

PUNTA GRANDE – BAJA VELOCIDAD
SIN ALCANCE A PROFUNDIDAD MÁXIMA

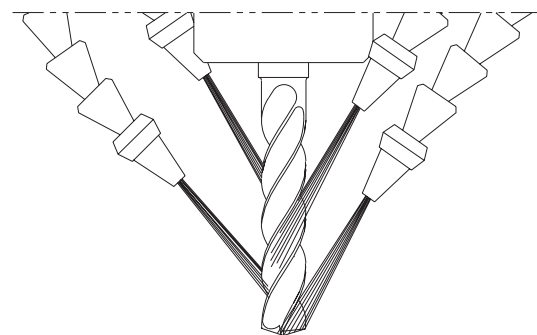

PUNTA PEQUEÑA – ALTA VELOCIDAD
COMPLETO ALCANCE

- Reducir el tamaño de la boquilla ayuda a maximizar los beneficios de refrigeración del exclusivo diseño de doble margen de la broca. Hi-PerCarb aumentando la velocidad. Coloque las boquillas en línea con el segundo filo que se encuentra entre los dos márgenes y también el filo para obtener mejores resultados.

Opérations de perçage

Recommandations en matière de refroidissement

- Le liquide de refroidissement sert à éloigner les copeaux de la zone de coupe, à réduire la chaleur dégagée durant la coupe et à minimiser la friction.
- Il est important d'optimiser la pression et la position du réfrigérant pour en retirer les bénéfices maximums durant la coupe.
- L'application adéquate de réfrigérant se traduit par des paramètres opératoires supérieurs, des taux d'élimination supérieurs des matériaux, de plus belles finitions des surfaces, une durée de vie des outils prévisible, moins de consommation d'énergie et des temps de cycle réduits.
- La pression est importante, mais une pression régulière et l'application sur l'outil sont des facteurs encore plus importants ; le refroidissement intermittent du carbure se traduit par des contraintes thermiques pour le matériau et la formation de microfissures.
- La propreté et le filtrage adéquats des réfrigérants sont importants pour qu'ils conservent leur propriétés, mais aussi pour éviter la réduction de pression du réfrigérant ou le risque d'obturation des conduits à réfrigérant dans les perceuses à réfrigérant intégré.

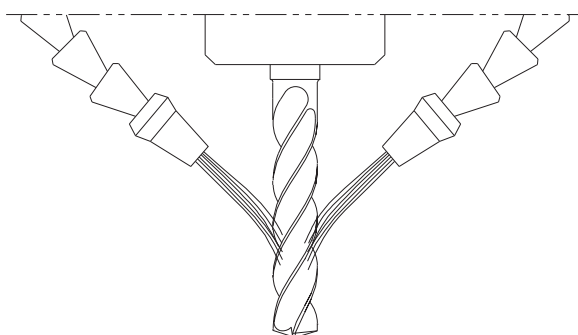
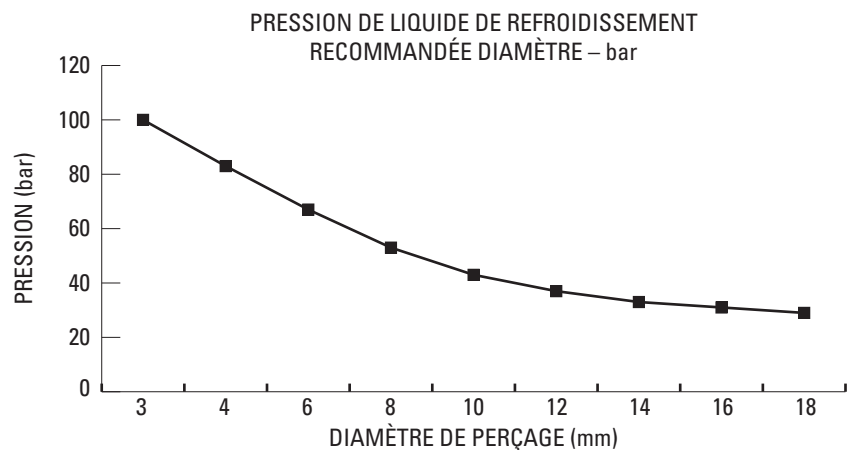
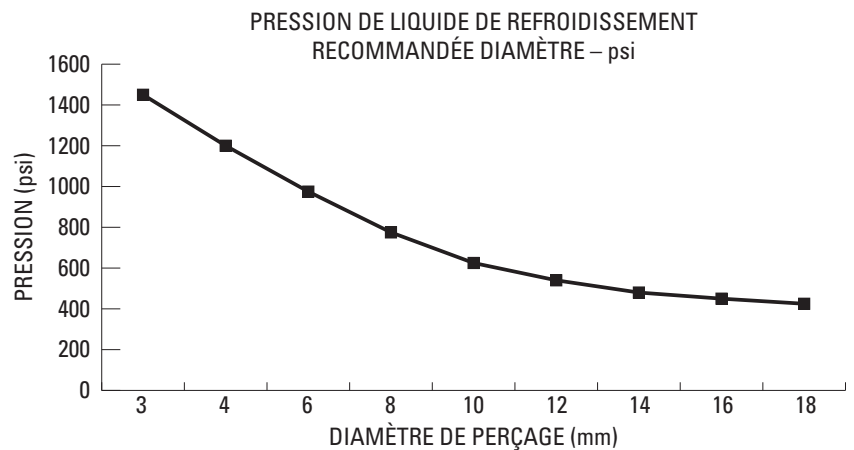

POINTE LARGE – BASSE VITESSE
PAS DE COUVERTURE À LA PROFONDEUR MAXIMUM

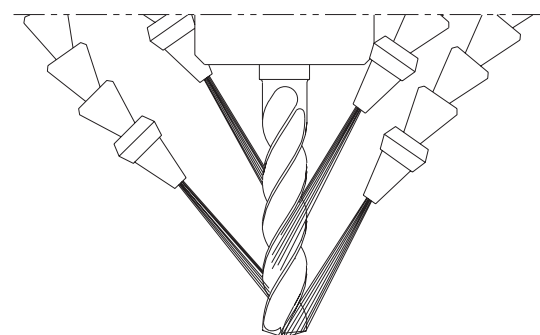

POINTE FINE – GRANDE VITESSE
COUVERTURE COMPLÈTE

- La réduction de la taille de l'embout permet de maximiser les bienfaits du refroidissement du concept à double listel original de la perceuse Hi-PerCarb en augmentant la vitesse. Pour les meilleurs résultats, orientez les embouts dans l'axe de la goujure secondaire située entre les deux listels, de même que la goujure primaire.

Bohrarbeiten Kühlmittelempfehlungen

- Kühlmittel dienen dazu, die Späne aus dem Schneidenbereich zu entfernen, die beim Schneiden erzeugte Wärme abzutransportieren und die Reibung zu verringern.
- Es kommt darauf an, den Kühlschmiermitteldruck und die Zufuhr zu optimieren, um alle Vorteile beim Bohren nutzen zu können.
- Der richtige Kühlschmiermitteleinsatz ermöglicht höhere Schnittparameter, höheren Materialabtrag, bessere Oberflächengüte, vorhersehbare Standzeiten und geringere Leistungsaufnahme und Laufzeiten.
- Der Druck ist wichtig, aber wichtiger ist dessen Konstanz und die Zufuhr zum Werkzeug. Unterbrochene Kühlung des Hartmetalls führt zur thermischen Belastung und Bildung von "Mikrorissen".
- Kühlmittel sind sauber zu halten und zu filtern, damit die Qualität des Kühlmittels erhalten bleibt und der Kühlmitteldruck durch Verstopfung der Kühlmittelkanäle im Bohrer nicht absinkt.

EMPFOHLENER KÜHLSCHMIERMITTELDRUCK
NACH DURCHMESSER – psi

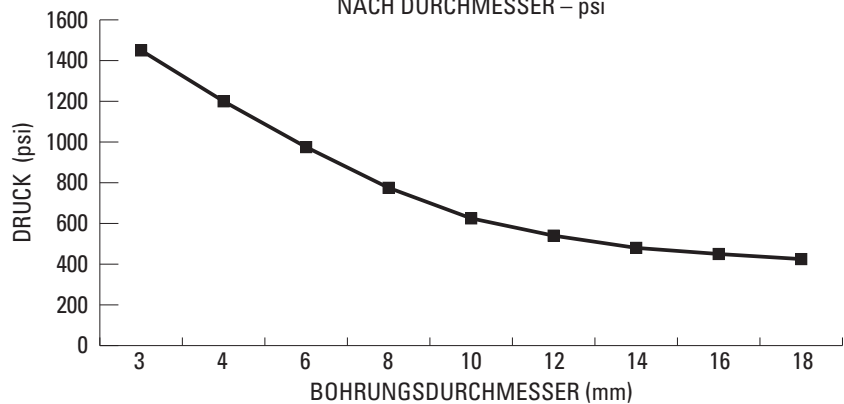

EMPFOHLENER KÜHLMITTELDRUCK
NACH DURCHMESSER – bar

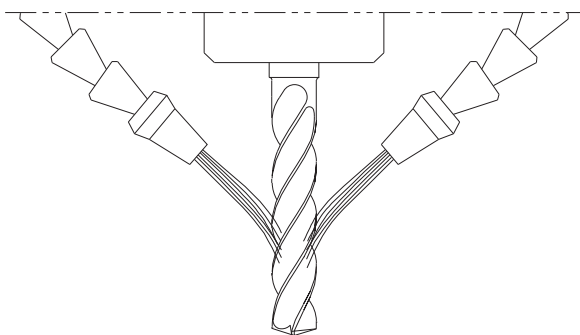
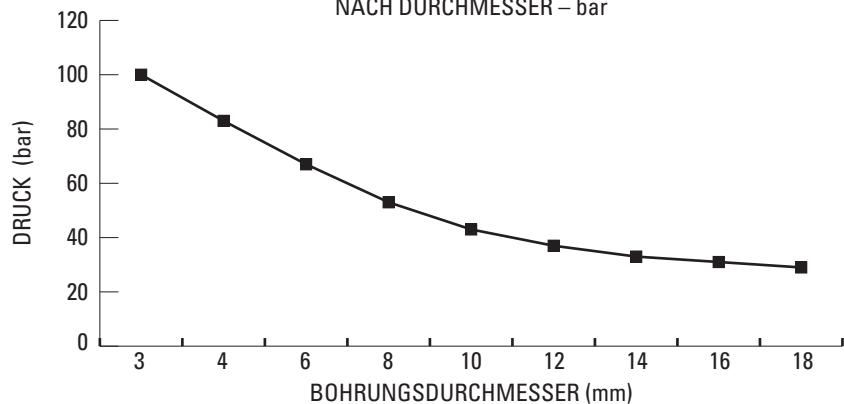

BREITE QUERSCHNEIDE – GERINGE DREHZAHL
KEINE VOLLSTÄNDIGE BENETZUNG BEI MAX. BOHRUNGSTIEFE

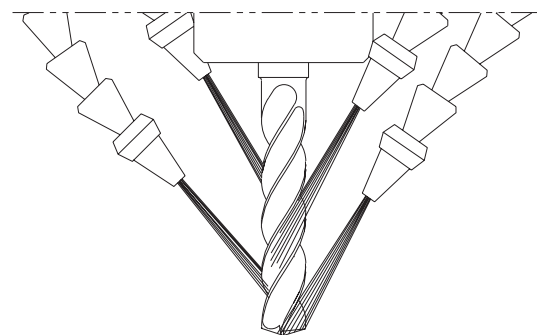

SCHMALE QUERSCHNEIDE – HOHE DREHZAHL
VOLLSTÄNDIGE BENETZUNG

- Durch Verringern der Düsengröße können die vorteilhaften Eigenschaften der Doppelfase genutzt werden, um die Drehzahl des Hi-PerCarb-Bohrers zu steigern. Richten Sie die Düsen auf die Nebennut zwischen beiden Fasen sowie auf die Schneiden aus, um beste Ergebnisse zu erzielen.

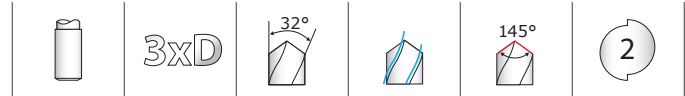

TOLERANCES (inch)

≤.1181 DIAMETER

DC = +.00008/+0.00047
DCON = h₆

>.1181-.2362 DIAMETER

DC = +.00016/+0.00063
DCON = h₆

>.2362-.3937 DIAMETER

DC = +.00024/+0.00083
DCON = h₆

>.3937-.7087 DIAMETER

DC = +.00028/+0.00098
DCON = h₆

>.7087-1.1811 DIAMETER

DC = +.00031/+0.00114
DCON = h₆

TOLERANCES (mm)

≤3 DIAMETER

DC = +0,002/+0,012
DCON = h₆

>3-6 DIAMETER

DC = +0,004/+0,016
DCON = h₆

>6-10 DIAMETER

DC = +0,006/+0,021
DCON = h₆

>10-18 DIAMETER

DC = +0,007/+0,025
DCON = h₆

>18-30 DIAMETER

DC = +0,008/+0,029
DCON = h₆

- STEELS
- STAINLESS STEELS
- CAST IRON
- HIGH TEMP ALLOYS
- TITANIUM
- NON-FERROUS
- HARDENED STEELS

For patent information visit
www.ksptpatents.com

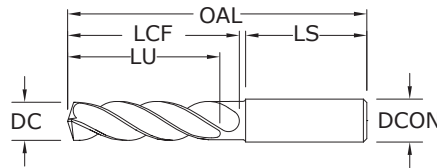

135 3xD
FRACTIONAL & METRIC SERIES

inch & mm										EDP NO.
CUTTING DIAMETER	DECIMAL EQUIV.	METRIC EQUIV.	TAP SIZE REFERENCE ONLY	SHANK DIAMETER DCON	OVERALL LENGTH OAL	FLUTE LENGTH LCF	CLEARED LENGTH LU	SHANK LENGTH LS	Ti-NAMITE-A (AITIN)	
1/64	0.0156	0.40		1/8	1-1/2	1/8	5/64	1	51752*	
1/32	0.0312	0.79		1/8	1-1/2	1/4	3/16	1	51269*	
3/64	0.0469	1.19	1/16-64	1/8	1-1/2	3/8	5/16	1	51270*	
1,25 mm	0.0492			3,0	38,0	9,5	8,0	25,0	64500*	
1,45 mm	0.0571			3,0	38,0	9,5	8,0	25,0	64501*	
#53	0.0595	1.51		1/8	1-1/2	3/8	5/16	1	64502*	
1/16	0.0625	1.59	5/64-60	1/8	2	7/16	3/8	1-1/4	51271*	
1,6 mm	0.0630			3,0	50,0	11,0	9,0	32,0	64503*	
1,75 mm	0.0689			3,0	50,0	11,0	9,0	32,0	64504*	
#50	0.0700	1.78		1/8	2	7/16	3/8	1-1/4	64505*	
5/64	0.0781	1.98		1/8	2	1/2	7/16	1-1/4	51272*	
#47	0.0785	1.99		1/8	2	1/2	7/16	1-1/4	64506*	
2,05 mm	0.0807			3,0	50,0	12,0	11,0	32,0	64507*	
#46	0.0810	2.06		1/8	2	1/2	7/16	1-1/4	64508*	
#43	0.0890	2.26		1/8	2	1/2	7/16	1-1/4	64509*	
#42	0.0935	2.37		1/8	2	1/2	7/16	1-1/4	64510*	
3/32	0.0938	2.38	1/8-32	1/8	2	1/2	7/16	1-1/4	51273	
#40	0.0980	2.49		1/8	2	9/16	1/2	1-1/4	51274	
2,5 mm	0.0984			3,0	50,0	14,0	12,0	32,0	64511	
#39	0.0995	2.53		1/8	2	9/16	1/2	1-1/4	51753	
#38	0.1015	2.58	5-40	1/8	2	9/16	1/2	1-1/4	51754	
#37	0.1040	2.64	5-44	1/8	2	9/16	1/2	1-1/4	51755	
#36	0.1065	2.71	6-32	1/8	2	9/16	1/2	1-1/4	51756	
7/64	0.1094	2.78		1/8	2	5/8	9/16	1-1/4	51275	
#35	0.1100	2.79		1/8	2	5/8	9/16	1-1/4	51276	
#34	0.1110	2.82		1/8	2	5/8	9/16	1-1/4	51277	
#33	0.1130	2.87	6-40	1/8	2	5/8	9/16	1-1/4	51757	
2,9 mm	0.1142			3,0	50,0	16,0	14,0	32,0	64512	
#32	0.1160	2.95		1/8	2	5/8	9/16	1-1/4	51758	
3,0 mm	0.1181			6,0	62,0	20,0	17,0	36,0	63155	
#31	0.1200	3.05		1/8	2	5/8	9/16	1-1/4	51759	
3,1 mm	0.1220			6,0	62,0	20,0	17,0	36,0	63741	
1/8	0.1250	3.18		1/4	2-1/2	3/4	21/32	1-7/16	51330	
3,2 mm	0.1260		M3,5 X 0,35	6,0	62,0	20,0	17,0	36,0	63156	
#30	0.1285	3.26		1/4	2-1/2	3/4	21/32	1-7/16	51278	
3,3 mm	0.1299		M4 X 0,7	6,0	62,0	20,0	17,0	36,0	63157	
3,4 mm	0.1339			6,0	62,0	20,0	17,0	36,0	63158	
#29	0.1360	3.45	8-32,8-36	1/4	2-1/2	3/4	21/32	1-7/16	51331	
3,5 mm	0.1378		M4 X 0,5	6,0	62,0	20,0	17,0	36,0	63159	
#28	0.1405	3.57	8-40	1/4	2-1/2	3/4	21/32	1-7/16	51760	
9/64	0.1406	3.57		1/4	2-1/2	3/4	21/32	1-7/16	51332	
3,6 mm	0.1417		M4 X 0,35	6,0	62,0	20,0	17,0	36,0	63160	
#27	0.1440	3.66		1/4	2-1/2	3/4	21/32	1-7/16	51761	
3,7 mm	0.1457		M4.5 X 0,75	6,0	62,0	20,0	17,0	36,0	63161	
#26	0.1470	3.73	3/16-24	1/4	2-1/2	3/4	21/32	1-7/16	51762	
#25	0.1495	3.80	10-24	1/4	2-5/8	7/8	23/32	1-7/16	51333	

*Single Margin

continued on next page

- Double margin design improves accuracy and surface finish along with increased strength for aggressive drilling
- Specialized self-centering notched point eliminates the need for spot drilling decreasing thrust and deflection
- Engineered edge protection improves edge strength and reduces edge fatigue allowing for increased feed rates
- Recommended for materials ≤ 56 HRC (≤ 577 Bhn)



135 3xD

FRACTIONAL & METRIC SERIES

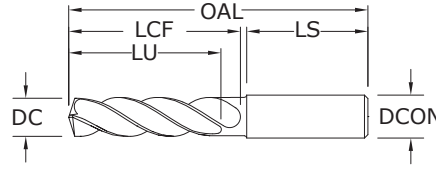

- Double margin design improves accuracy and surface finish along with increased strength for aggressive drilling
- Specialized self-centering notched point eliminates the need for spot drilling decreasing thrust and deflection
- Engineered edge protection improves edge strength and reduces edge fatigue allowing for increased feed rates
- Recommended for materials ≤ 56 HRc (≤ 577 Bhn)

inch & mm										EDP NO.
CUTTING DIAMETER DC	DECIMAL EQUIV.	METRIC EQUIV.	TAP SIZE REFERENCE ONLY	SHANK DIAMETER DCON	OVERALL LENGTH OAL	FLUTE LENGTH LCF	CLEARED LENGTH LU	SHANK LENGTH LS		Ti-NAMITE-A (AITiN)
3,8 mm	0.1496			6,0	66,0	24,0	21,0	36,0		63742
#24	0.1520	3.86	10-28	1/4	2-5/8	7/8	23/32	1-7/16		51763
3,9 mm	0.1535			6,0	66,0	24,0	21,0	36,0		63743
#23	0.1540	3.91		1/4	2-5/8	7/8	23/32	1-7/16		51764
5/32	0.1562	3.97		1/4	2-5/8	7/8	23/32	1-7/16		51334
#22	0.1570	3.99	10-30	1/4	2-5/8	7/8	23/32	1-7/16		51765
4,0 mm	0.1575		M4,5 X 0,5	6,0	66,0	24,0	21,0	36,0		63162
#21	0.1590	4.04	10-32	1/4	2-5/8	7/8	23/32	1-7/16		51335
#20	0.1610	4.09	13/64-24	1/4	2-5/8	7/8	23/32	1-7/16		51279
4,1 mm	0.1614			6,0	66,0	24,0	21,0	36,0		63744
4,2 mm	0.1654		M5 / M5 X 0,75	6,0	66,0	24,0	21,0	36,0		63163
#19	0.1660	4.22		1/4	2-5/8	7/8	23/32	1-7/16		51766
4,3 mm	0.1693			6,0	66,0	24,0	21,0	36,0		63164
#18	0.1695	4.31		1/4	2-5/8	7/8	23/32	1-7/16		51767
11/64	0.1719	4.37		1/4	2-5/8	7/8	23/32	1-7/16		51336
#17	0.1730	4.39		1/4	2-5/8	7/8	23/32	1-7/16		51768
4,4 mm	0.1732			6,0	66,0	24,0	21,0	36,0		63745
#16	0.1770	4.50	12-24	1/4	2-5/8	7/8	23/32	1-7/16		51769
4,5 mm	0.1772		M5 X 0,5	6,0	66,0	24,0	21,0	36,0		63165
#15	0.1800	4.57		1/4	2-5/8	7/8	23/32	1-7/16		51770
4,6 mm	0.1811		12-28	6,0	66,0	24,0	21,0	36,0		63166
#14	0.1820	4.62		1/4	2-5/8	7/8	23/32	1-7/16		51771
#13	0.1850	4.70	12-32	1/4	2-5/8	7/8	23/32	1-7/16		51772
4,7 mm	0.1850			6,0	66,0	24,0	21,0	36,0		63746
3/16	0.1875	4.76		1/4	2-5/8	1	53/64	1-7/16		51337
#12	0.1890	4.80	7/32-32	1/4	2-5/8	1	53/64	1-7/16		51773
4,8 mm	0.1890			6,0	66,0	28,0	24,0	36,0		63167
#11	0.1910	4.85		1/4	2-5/8	1	53/64	1-7/16		51774
4,9 mm	0.1929			6,0	66,0	28,0	24,0	36,0		63747
#10	0.1935	4.91	14-20	1/4	2-5/8	1	53/64	1-7/16		51775
#9	0.1960	4.98		1/4	2-5/8	1	53/64	1-7/16		51776
5,0 mm	0.1969		M6 X 1	6,0	66,0	28,0	24,0	36,0		63168
#8	0.1990	5.05		1/4	2-5/8	1	53/64	1-7/16		51777
5,1 mm	0.2008			6,0	66,0	28,0	24,0	36,0		63748
#7	0.2010	5.11	1/4-20	1/4	2-5/8	1	53/64	1-7/16		51338
13/64	0.2031	5.16		1/4	2-5/8	1	53/64	1-7/16		51339
#6	0.2040	5.18		1/4	2-5/8	1	53/64	1-7/16		51778
5,2 mm	0.2047		M6 X 0,75	6,0	66,0	28,0	24,0	36,0		63749
#5	0.2055	5.22		1/4	2-5/8	1	53/64	1-7/16		51779
5,25 mm	0.2067			6,0	66,0	28,0	24,0	36,0		63169
5,3 mm	0.2087			6,0	66,0	28,0	24,0	36,0		63170
#4	0.2090	5.31	1/4-24	1/4	2-5/8	1	53/64	1-7/16		51780
5,4 mm	0.2126			6,0	66,0	28,0	24,0	36,0		63750
#3	0.2130	5.41	1/4-28	1/4	2-5/8	1	53/64	1-7/16		51340
5,5 mm	0.2165		M6 X 0,5	6,0	66,0	28,0	24,0	36,0		63171
7/32	0.2188	5.56	1/4-32	1/4	2-5/8	1	53/64	1-7/16		51341

continued on next page

TOLERANCES (inch)

$\leq .1181$ DIAMETER
DC = +.00008/+0.00047
DCON = h_6

>.1181-.2362 DIAMETER
DC = +.00016/+0.00063
DCON = h_6

>.2362-.3937 DIAMETER
DC = +.00024/+0.00083
DCON = h_6

>.3937-.7087 DIAMETER
DC = +.00028/+0.00098
DCON = h_6

>.7087-1.1811 DIAMETER
DC = +.00031/+0.00114
DCON = h_6

TOLERANCES (mm)

≤ 3 DIAMETER
DC = +0,002/+0,012
DCON = h_6

>3-6 DIAMETER
DC = +0,004/+0,016
DCON = h_6

>6-10 DIAMETER
DC = +0,006/+0,021
DCON = h_6

>10-18 DIAMETER
DC = +0,007/+0,025
DCON = h_6

>18-30 DIAMETER
DC = +0,008/+0,029
DCON = h_6

- STEELS
- STAINLESS STEELS
- CAST IRON
- HIGH TEMP ALLOYS
- TITANIUM
- NON-FERROUS
- HARDENED STEELS

For patent information visit www.ksptpatents.com



135 3xD
FRACTIONAL & METRIC SERIES

CUTTING DIAMETER DC	DECIMAL EQUIV.	METRIC EQUIV.	inch & mm						EDP NO.
			TAP SIZE REFERENCE ONLY	SHANK DIAMETER DCON	OVERALL LENGTH OAL	FLUTE LENGTH LCF	CLEARED LENGTH LU	SHANK LENGTH LS	Ti-NAMITE-A (AITiN)
5,6 mm	0.2205			6,0	66,0	28,0	24,0	36,0	63751
#2	0.2210	5.61		1/4	2-5/8	1	53/64	1-7/16	51781
5,7 mm	0.2244			6,0	66,0	28,0	24,0	36,0	63752
#1	0.2280	5.79		1/4	2-5/8	1	53/64	1-7/16	51782
5,8 mm	0.2283			6,0	66,0	28,0	24,0	36,0	63172
5,9 mm	0.2323			6,0	66,0	28,0	24,0	36,0	63753
A	0.2340	5.94		1/4	2-5/8	1	53/64	1-7/16	51601
15/64	0.2344	5.95		1/4	2-5/8	1	53/64	1-7/16	51342
6,0 mm	0.2362	6.00	M7 X 1	6,0	66,0	28,0	24,0	36,0	63173
B	0.2380	6.05		1/4	3-1/8	1-5/16	1-3/64	1-7/16	51602
6,1 mm	0.2402			8,0	79,0	34,0	28,0	36,0	63754
C	0.2420	6.15		1/4	3-1/8	1-5/16	1-3/64	1-7/16	51603
6,2 mm	0.2441			8,0	79,0	34,0	28,0	36,0	63755
D	0.2460	6.25		1/4	3-1/8	1-5/16	1-3/64	1-7/16	51604
6,25 mm	0.2461		M7 X 0,75	8,0	79,0	34,0	28,0	36,0	63174
6,3 mm	0.2480			8,0	79,0	34,0	28,0	36,0	63756
1/4	0.2500	6.35		1/4	3-1/8	1-5/16	1-3/64	1-7/16	51343
6,4 mm	0.2520			8,0	79,0	34,0	28,0	36,0	63175
6,5 mm	0.2559			8,0	79,0	34,0	28,0	36,0	63213
F	0.2570	6.53	5/16-18	5/16	3-1/8	1-5/16	1-3/64	1-7/16	51344
6,6 mm	0.2598			8,0	79,0	34,0	28,0	36,0	63757
G	0.2610	6.63		5/16	3-1/8	1-5/16	1-3/64	1-7/16	51606
6,7 mm	0.2638			8,0	79,0	34,0	28,0	36,0	63758
17/64	0.2656	6.75	5/16-20	5/16	3-1/8	1-5/16	1-3/64	1-7/16	51345
H	0.2660	6.76		5/16	3-1/8	1-5/16	1-3/64	1-7/16	51607
6,8 mm	0.2677		M8 X 1,25	8,0	79,0	34,0	28,0	36,0	63176
6,9 mm	0.2717			8,0	79,0	34,0	28,0	36,0	63759
I	0.2720	6.91	5/16-24	5/16	3-1/8	1-5/16	1-3/64	1-7/16	51346
7,0 mm	0.2756		M8 X 1	8,0	79,0	34,0	28,0	36,0	63177
J	0.2770	7.04		5/16	3-1/8	1-5/16	1-3/64	1-7/16	51608
7,1 mm	0.2795			8,0	79,0	41,0	34,0	36,0	63760
K	0.2810	7.14		5/16	3-1/8	1-9/16	1-3/16	1-7/16	51609
9/32	0.2812	7.14	5/16-32	5/16	3-1/8	1-9/16	1-3/16	1-7/16	51347
7,2 mm	0.2835			8,0	79,0	41,0	34,0	36,0	63761
7,25 mm	0.2854		M8 X 0,75	8,0	79,0	41,0	34,0	36,0	63178
7,3 mm	0.2874			8,0	79,0	41,0	34,0	36,0	63762
L	0.2900	7.37		5/16	3-1/8	1-9/16	1-3/16	1-7/16	51610
7,4 mm	0.2913			8,0	79,0	41,0	34,0	36,0	63763
M	0.2950	7.49		5/16	3-1/8	1-9/16	1-3/16	1-7/16	51611
7,5 mm	0.2953		M8 X 0,5	8,0	79,0	41,0	34,0	36,0	63179
19/64	0.2969	7.54		5/16	3-1/8	1-9/16	1-3/16	1-7/16	51348
7,6 mm	0.2992			8,0	79,0	41,0	34,0	36,0	63764
N	0.3020	7.67		5/16	3-1/8	1-9/16	1-3/16	1-7/16	51612
7,7 mm	0.3031			8,0	79,0	41,0	34,0	36,0	63765
7,8 mm	0.3071		M9 X 1,25	8,0	79,0	41,0	34,0	36,0	63180
7,9 mm	0.3110			8,0	79,0	41,0	34,0	36,0	63766
5/16	0.3125	7.94	3/8-16	5/16	3-1/8	1-9/16	1-3/16	1-7/16	51349
8,0 mm	0.3150		M9 x 1	8,0	79,0	41,0	34,0	36,0	63181
O	0.3160	8.03		3/8	3-1/2	1-27/32	1-37/64	1-9/16	51613
8,1 mm	0.3189			10,0	89,0	47,0	40,0	40,0	63767
8,2 mm	0.3228			10,0	89,0	47,0	40,0	40,0	63768
P	0.3230	8.20		3/8	3-1/2	1-27/32	1-37/64	1-9/16	51614
8,3 mm	0.3268			10,0	89,0	47,0	40,0	40,0	63769
21/64	0.3281	8.33	3/8-20	3/8	3-1/2	1-27/32	1-37/64	1-9/16	51350
8,4 mm	0.3307			10,0	89,0	47,0	40,0	40,0	63182
Q	0.3320	8.43	3/8-24	3/8	3-1/2	1-27/32	1-37/64	1-9/16	51351
8,5 mm	0.3346		M10 X 1,5	10,0	89,0	47,0	40,0	40,0	63183
8,6 mm	0.3386			10,0	89,0	47,0	40,0	40,0	63770

continued on next page

CONTINUED



3xD



135 3xD

FRACTIONAL & METRIC SERIES

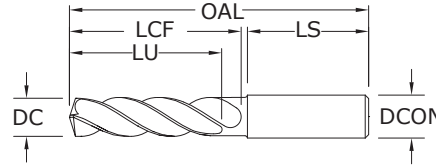

- Double margin design improves accuracy and surface finish along with increased strength for aggressive drilling
- Specialized self-centering notched point eliminates the need for spot drilling decreasing thrust and deflection
- Engineered edge protection improves edge strength and reduces edge fatigue allowing for increased feed rates
- Recommended for materials ≤ 56 HRc (≤ 577 Bhn)

CUTTING DIAMETER DC	DECIMAL EQUIV.	METRIC EQUIV.	TAP SIZE REFERENCE ONLY	inch & mm					EDP NO. Ti-NAMITE-A (AITIN)
				SHANK DIAMETER DCON	OVERALL LENGTH OAL	FLUTE LENGTH LCF	CLEARED LENGTH LU	SHANK LENGTH LS	
R	0.3390	8.61		3/8	3-1/2	1-27/32	1-37/64	1-9/16	51615
8,7 mm	0.3425			10,0	89,0	47,0	40,0	40,0	63771
11/32	0.3438	8.73	3/8-32	3/8	3-1/2	1-27/32	1-37/64	1-9/16	51352
8,8 mm	0.3465		M10 X 1,25	10,0	89,0	47,0	40,0	40,0	63184
S	0.3480	8.84		3/8	3-1/2	1-27/32	1-37/64	1-9/16	51616
8,9 mm	0.3504			10,0	89,0	47,0	40,0	40,0	63772
9,0 mm	0.3543		M10 X 1	10,0	89,0	47,0	40,0	40,0	63185
T	0.3580	9.09		3/8	3-1/2	1-27/32	1-37/64	1-9/16	51617
9,1 mm	0.3583			10,0	89,0	47,0	40,0	40,0	63773
23/64	0.3594	9.13		3/8	3-1/2	1-27/32	1-37/64	1-9/16	51353
9,2 mm	0.3622		M10 X 0,75	10,0	89,0	47,0	40,0	40,0	63774
9,25 mm	0.3642	9.25		10,0	89,0	47,0	40,0	40,0	63186
9,3 mm	0.3661			10,0	89,0	47,0	40,0	40,0	63775
U	0.3680	9.35	7/16-14	3/8	3-1/2	1-27/32	1-37/64	1-9/16	51354
9,4 mm	0.3701			10,0	89,0	47,0	40,0	40,0	63776
9,5 mm	0.3740		M10 X 0,5	10,0	89,0	47,0	40,0	40,0	63187
3/8	0.3750	9.53		3/8	3-1/2	1-27/32	1-37/64	1-9/16	51355
V	0.3770	9.58		1/2	3-1/2	1-27/32	1-37/64	1-9/16	51618
9,6 mm	0.3780			10,0	89,0	47,0	40,0	40,0	63777
9,7 mm	0.3819			10,0	89,0	47,0	40,0	40,0	63778
9,8 mm	0.3858			10,0	89,0	47,0	40,0	40,0	63779
W	0.3860			1/2	3-1/2	1-27/32	1-37/64	1-9/16	51619
9,9 mm	0.3898			10,0	89,0	47,0	40,0	40,0	63780
25/64	0.3906	9.92	7/16-20	1/2	3-1/2	1-27/32	1-37/64	1-9/16	51356
10,0 mm	0.3937			10,0	89,0	47,0	40,0	40,0	63188
X	0.3970	10.08	7/16-24	1/2	4-1/16	2-3/16	1-51/64	1-49/64	51620
10,1 mm	0.3976			12,0	102,0	55,0	45,0	45,0	63781
10,2 mm	0.4016		M12 X 1,75	12,0	102,0	55,0	45,0	45,0	63189
Y	0.4040	10.26	7/16-28	1/2	4-1/16	2-3/16	1-51/64	1-49/64	51621
10,3 mm	0.4055			12,0	102,0	55,0	45,0	45,0	63782
13/32	0.4062	10.32		1/2	4-1/16	2-3/16	1-51/64	1-49/64	51357
10,4 mm	0.4094			12,0	102,0	55,0	45,0	45,0	63783
Z	0.4130	10.49		1/2	4-1/16	2-3/16	1-51/64	1-49/64	51622
10,5 mm	0.4134		M12 X 1,5	12,0	102,0	55,0	45,0	45,0	63190
10,6 mm	0.4173			12,0	102,0	55,0	45,0	45,0	63784
10,7 mm	0.4213			12,0	102,0	55,0	45,0	45,0	63785
27/64	0.4219	10.72	1/2-13	1/2	4-1/16	2-3/16	1-51/64	1-49/64	51358
10,8 mm	0.4252		M12 X 1,25	12,0	102,0	55,0	45,0	45,0	63191
10,9 mm	0.4291			12,0	102,0	55,0	45,0	45,0	63786
11,0 mm	0.4331		M12 X 1	12,0	102,0	55,0	45,0	45,0	63192
11,1 mm	0.4370	11.11	1/4-18 NPT	1/2	4-1/16	2-3/16	1-51/64	1-49/64	51359
7/16	0.4375			1/2	4-1/16	2-3/16	1-51/64	1-49/64	51359
11,2 mm	0.4409			12,0	102,0	55,0	45,0	45,0	63788
11,25 mm	0.4429			12,0	102,0	55,0	45,0	45,0	63193
11,3 mm	0.4449			12,0	102,0	55,0	45,0	45,0	63789

continued on next page

TOLERANCES (inch)

- $\leq .1181$ DIAMETER
DC = $+0.0008/+0.0047$
DCON = h_6
- $>.1181-.2362$ DIAMETER
DC = $+0.0016/+0.0063$
DCON = h_6
- $>.2362-.3937$ DIAMETER
DC = $+0.0024/+0.0083$
DCON = h_6
- $>.3937-.7087$ DIAMETER
DC = $+0.0028/+0.0098$
DCON = h_6
- $>.7087-1.1811$ DIAMETER
DC = $+0.0031/+0.0114$
DCON = h_6

TOLERANCES (mm)

- ≤ 3 DIAMETER
DC = $+0,004/+0,012$
DCON = h_6
- $>3-6$ DIAMETER
DC = $+0,004/+0,016$
DCON = h_6
- $>6-10$ DIAMETER
DC = $+0,006/+0,021$
DCON = h_6
- $>10-18$ DIAMETER
DC = $+0,007/+0,025$
DCON = h_6
- $>18-30$ DIAMETER
DC = $+0,008/+0,029$
DCON = h_6

- STEELS
- STAINLESS STEELS
- CAST IRON
- HIGH TEMP ALLOYS
- TITANIUM
- NON-FERROUS
- HARDENED STEELS

For patent information visit www.ksptpatents.com



135 3xD

FRACTIONAL & METRIC SERIES

inch & mm										EDP NO.
CUTTING DIAMETER DC	DECIMAL EQUIV.	METRIC EQUIV.	TAP SIZE REFERENCE ONLY	SHANK DIAMETER DCON	OVERALL LENGTH OAL	FLUTE LENGTH LCF	CLEARED LENGTH LU	SHANK LENGTH LS	TI-NAMITE-A (AITIN)	
11,4 mm	0.4488			12,0	102,0	55,0	45,0	45,0	63790	
11,5 mm	0.4528		M12 X 0,5	12,0	102,0	55,0	45,0	45,0	63194	
29/64	0.4531	11.51	1/2-20	1/2	4-1/16	2-3/16	1-51/64	1-49/64	51360	
11,6 mm	0.4567			12,0	102,0	55,0	45,0	45,0	63791	
11,7 mm	0.4606			12,0	102,0	55,0	45,0	45,0	63792	
11,8 mm	0.4646			12,0	102,0	55,0	45,0	45,0	63793	
11,9 mm	0.4685			12,0	102,0	55,0	45,0	45,0	63794	
15/32	0.4688	11.91	1/2-28	1/2	4-1/16	2-3/16	1-51/64	1-49/64	51361	
12,0 mm	0.4724		M14 X 2	12,0	102,0	55,0	45,0	45,0	63195	
31/64	0.4844	12.30	9/16-12	1/2	4-1/4	2-5/16	1-7/8	1-49/64	51362	
12,5 mm	0.4921		M14 X 1,5	14,0	107,0	60,0	49,0	45,0	63196	
1/2	0.5000	12.70		1/2	4-1/4	2-5/16	1-7/8	1-49/64	51363	
12,8 mm	0.5039		M14 X 1,25	14,0	107,0	60,0	49,0	45,0	63197	
13,0 mm	0.5118		M14 X 1	14,0	107,0	60,0	49,0	45,0	63198	
33/64	0.5156	13.10	9/16-18	5/8	4-1/4	2-5/16	1-7/8	1-49/64	51364	
17/32	0.5312	13.49	5/8-11	5/8	4-1/4	2-5/16	1-7/8	1-49/64	51365	
13,5 mm	0.5315			14,0	107,0	60,0	49,0	45,0	63199	
35/64	0.5469	13.89	5/8-12	5/8	4-1/4	2-5/16	1-7/8	1-49/64	51783	
14,0 mm	0.5512		M16 X 2	14,0	107,0	60,0	49,0	45,0	63200	
9/16	0.5625	14.29		5/8	4-9/16	2-1/2	2	1-57/64	51366	
14,5 mm	0.5709		M16 X 1,5	16,0	115,0	65,0	51,0	48,0	63201	
37/64	0.5781	14.68	5/8-18	5/8	4-9/16	2-1/2	2	1-57/64	51367	
15,0 mm	0.5906		M16 X 1	16,0	115,0	65,0	51,0	48,0	63202	
19/32	0.5938	15.08	11/16-11	5/8	4-9/16	2-1/2	2	1-57/64	51784	
39/64	0.6094	15.48	11/16-12	5/8	4-9/16	2-1/2	2	1-57/64	51785	
15,5 mm	0.6102		M18 X 2,5	16,0	115,0	65,0	51,0	48,0	63203	
5/8	0.6250	15.88	11/16-16	5/8	4-9/16	2-1/2	2	1-57/64	51368	
16,0 mm	0.6299			16,0	115,0	65,0	51,0	48,0	63204	
41/64	0.6406	16.27	11/16-24	3/4	4-7/8	2-3/4	2-5/16	1-57/64	51786	
16,5 mm	0.6496		M18 X 1,5	18,0	123,0	73,0	58,0	48,0	63205	
21/32	0.6562	16.67	3/4-10	3/4	4-7/8	2-3/4	2-5/16	1-57/64	51369	
17,0 mm	0.6693			18,0	123,0	73,0	58,0	48,0	63206	
43/64	0.6719	17.07	3/4-12	3/4	4-7/8	2-3/4	2-5/16	1-57/64	51787	
11/16	0.6875	17.46	3/4-16	3/4	4-7/8	2-3/4	2-5/16	1-57/64	51370	
17,5 mm	0.6890		M20 X 2,5	18,0	123,0	73,0	58,0	48,0	63207	
45/64	0.7031	17.86	3/4-20, 1/2-14 NPT	3/4	4-7/8	2-3/4	2-5/16	1-57/64	51788	
18,0 mm	0.7087			18,0	123,0	73,0	58,0	48,0	63208	
23/32	0.7188	18.26		3/4	4-7/8	2-3/4	2-5/16	1-57/64	51789	
18,5 mm	0.7283		M20 X 1,5	20,0	131,0	79,0	63,0	50,0	63209	
47/64	0.7344	18.65	13/16-12	3/4	4-7/8	2-3/4	2-5/16	1-57/64	51790	
19,0 mm	0.7480			20,0	131,0	79,0	63,0	50,0	63210	
3/4	0.7500	19.05	13/16-16	3/4	5-1/4	3-1/16	2-7/16	1-31/32	51371	
49/64	0.7656	19.45	7/8-9	7/8	5-1/4	3-1/16	2-7/16	1-31/32	51372	
19,5 mm	0.7677		M22 X 2,5	20,0	131,0	79,0	63,0	50,0	63211	
25/32	0.7812	19.84		7/8	6	3-11/16	2-11/16	2-1/8	51791	
20,0 mm	0.7874			20,0	131,0	79,0	63,0	50,0	63212	
51/64	0.7969	20.24	7/8-12	7/8	6	3-11/16	2-11/16	2-1/8	51792	
20,5 mm	0.8071			22,0	150,0	93,0	73,0	53,0	64513	
13/16	0.8125	20.64	7/8-14	7/8	6	3-11/16	2-11/16	2-1/8	51373	
21,0 mm	0.8268			22,0	150,0	93,0	73,0	53,0	64514	
22,0 mm	0.8661			22,0	150,0	93,0	73,0	53,0	64515	
7/8	0.8750	22.23	15/16-16, 1-8	7/8	6	3-11/16	2-11/16	2-1/8	51374	
59/64	0.9219	23.42	1-12	1	6	3-11/16	2-11/16	2-1/8	51375	

CONTINUED

FRACTIONAL
Hi-PerCarb®

Series 135 3D Fractional	Hardness	Vc (sfm)	DC • in								
			1/32	1/8	1/4	3/8	1/2	5/8	7/8		
P CARBON STEELS 1018, 1040, 1080, 1090, 10L50, 1140, 1212, 12L15, 1525, 1536	≤ 175 Bhn or ≤ 7 HRc	385	RPM	47062	11766	5883	3922	2941	2353	1681	
		(308-462)	Fr	0.0010	0.0038	0.0076	0.0115	0.0153	0.0191	0.0268	
			Feed (ipm)	45.0	45.0	45.0	45.0	45.0	45.0	45.0	
	≤ 275 Bhn or ≤ 28 HRc	350	RPM	42784	10696	5348	3565	2674	2139	1528	
		(280-420)	Fr	0.0009	0.0036	0.0071	0.0107	0.0142	0.0178	0.0249	
			Feed (ipm)	38.0	38.0	38.0	38.0	38.0	38.0	38.0	
	≤ 425 Bhn or ≤ 45 HRc	200	RPM	24448	6112	3056	2037	1528	1222	873	
		(160-240)	Fr	0.0007	0.0029	0.0059	0.0088	0.0118	0.0147	0.0206	
			Feed (ipm)	18.0	18.0	18.0	18.0	18.0	18.0	18.0	
	M ALLOY STEELS 4140, 4150, 4320, 5120, 5150, 8630, 86L20, 50100	≤ 275 Bhn or ≤ 28 HRc	300	RPM	36672	9168	4584	3056	2292	1834	1310
			(240-360)	Fr	0.0007	0.0029	0.0059	0.0088	0.0118	0.0147	0.0206
				Feed (ipm)	27.0	27.0	27.0	27.0	27.0	27.0	27.0
≤ 375 Bhn or ≤ 40 HRc		185	RPM	22614	5654	2827	1885	1413	1131	808	
		(148-222)	Fr	0.0006	0.0026	0.0051	0.0077	0.0103	0.0128	0.0180	
			Feed (ipm)	14.5	14.5	14.5	14.5	14.5	14.5	14.5	
≤ 450 Bhn or ≤ 48 HRc		130	RPM	15891	3973	1986	1324	993	795	568	
		(104-156)	Fr	0.0004	0.0018	0.0035	0.0053	0.0070	0.0088	0.0123	
			Feed (ipm)	7.0	7.0	7.0	7.0	7.0	7.0	7.0	
K STAINLESS STEELS (FREE MACHINING) 303, 416, 420F, 430F, 440F		≤ 185 Bhn or ≤ 9 HRc	275	RPM	33616	8404	4202	2801	2101	1681	1201
			(220-330)	Fr	0.0006	0.0026	0.0051	0.0077	0.0102	0.0128	0.0179
				Feed (ipm)	21.5	21.5	21.5	21.5	21.5	21.5	21.5
	≤ 275 Bhn or ≤ 28 HRc	170	RPM	20781	5195	2598	1732	1299	1039	742	
		(136-204)	Fr	0.0005	0.0020	0.0040	0.0061	0.0081	0.0101	0.0141	
			Feed (ipm)	10.5	10.5	10.5	10.5	10.5	10.5	10.5	
K STAINLESS STEELS (DIFFICULT) 304, 316, 321, 13-8 PH, 15-5PH, 17-4 PH, Custom 450	≤ 275 Bhn or ≤ 28 HRc	90	RPM	11002	2750	1375	917	688	550	393	
		(72-108)	Fr	0.0005	0.0020	0.0040	0.0060	0.0080	0.0100	0.0140	
			Feed (ipm)	5.5	5.5	5.5	5.5	5.5	5.5	5.5	
	≤ 375 Bhn or ≤ 40 HRc	65	RPM	7946	1986	993	662	497	397	284	
		(52-78)	Fr	0.0004	0.0018	0.0035	0.0053	0.0070	0.0088	0.0123	
			Feed (ipm)	3.5	3.5	3.5	3.5	3.5	3.5	3.5	
K CAST IRONS Gray, Malleable, Ductile	≤ 220 Bhn or ≤ 19 HRc	320	RPM	39117	9779	4890	3260	2445	1956	1397	
		(256-384)	Fr	0.0012	0.0046	0.0092	0.0138	0.0184	0.0230	0.0322	
			Feed (ipm)	45.0	45.0	45.0	45.0	45.0	45.0	45.0	
	≤ 260 Bhn or ≤ 26 HRc	285	RPM	34838	8710	4355	2903	2177	1742	1244	
		(228-342)	Fr	0.0011	0.0046	0.0092	0.0138	0.0184	0.0230	0.0321	
			Feed (ipm)	40.0	40.0	40.0	40.0	40.0	40.0	40.0	

continued on next page

Series 135 3D Fractional	Hardness	Vc (sfm)	DC • in								
			1/32	1/8	1/4	3/8	1/2	5/8	7/8		
N ALUMINUM ALLOYS 2017, 2024, 356, 6061, 7075	≤ 80 Bhn or ≤ 47 HRb	700	RPM	85568	21392	10696	7131	5348	4278	3056	
		(560-840)	Fr	0.0012	0.0049	0.0098	0.0147	0.0196	0.0245	0.0344	
			Feed (ipm)	105.0	105.0	105.0	105.0	105.0	105.0	105.0	
	≤ 150 Bhn or ≤ 7 HRc	600	RPM	73344	18336	9168	6112	4584	3667	2619	
		(480-720)	Fr	0.0012	0.0050	0.0099	0.0149	0.0199	0.0248	0.0347	
			Feed (ipm)	91.0	91.0	91.0	91.0	91.0	91.0	91.0	
	COPPER ALLOYS Alum Bronze, C110, Muntz Brass	≤ 140 Bhn or ≤ 3 HRc	500	RPM	61120	15280	7640	5093	3820	3056	2183
			(400-600)	Fr	0.0005	0.0020	0.0039	0.0059	0.0079	0.0098	0.0137
				Feed (ipm)	30.0	30.0	30.0	30.0	30.0	30.0	30.0
		≤ 200 Bhn or ≤ 23 HRc	400	RPM	48896	12224	6112	4075	3056	2445	1746
			(320-480)	Fr	0.0005	0.0020	0.0040	0.0060	0.0080	0.0100	0.0140
				Feed (ipm)	24.5	24.5	24.5	24.5	24.5	24.5	24.5
S SUPER ALLOYS (NICKEL, COBALT, IRON BASE) Inconel 601, 617, 625, Incoloy, Monel 400, Rene, Waspaloy	≤ 300 Bhn or ≤ 32 HRc	55	RPM	6723	1681	840	560	420	336	240	
		(44-66)	Fr	0.0002	0.0008	0.0015	0.0023	0.0031	0.0039	0.0054	
			Feed (ipm)	1.3	1.3	1.3	1.3	1.3	1.3	1.3	
	≤ 400 Bhn or ≤ 43 HRc	30	RPM	3667	917	458	306	229	183	131	
		(24-36)	Fr	0.0002	0.0007	0.0013	0.0020	0.0026	0.0033	0.0046	
			Feed (ipm)	0.6	0.6	0.6	0.6	0.6	0.6	0.6	
	TITANIUM ALLOYS Pure Titanium, Ti6Al4V, Ti6Al2Sn4Zr2Mo, Ti4Al4Mo2Sn0.5Si, Ti-6Al4V	≤ 275 Bhn or ≤ 28 HRc	135	RPM	16502	4126	2063	1375	1031	825	589
			(108-162)	Fr	0.0004	0.0018	0.0035	0.0053	0.0071	0.0088	0.0124
				Feed (ipm)	7.3	7.3	7.3	7.3	7.3	7.3	7.3
		≤ 350 Bhn or ≤ 38 HRc	100	RPM	12224	3056	1528	1019	764	611	437
			(80-120)	Fr	0.0004	0.0016	0.0033	0.0049	0.0065	0.0082	0.0115
				Feed (ipm)	5.0	5.0	5.0	5.0	5.0	5.0	5.0
≤ 440 Bhn or ≤ 47 HRc	55	RPM	6723	1681	840	560	420	336	240		
	(44-66)	Fr	0.0003	0.0012	0.0024	0.0036	0.0048	0.0059	0.0083		
		Feed (ipm)	2.0	2.0	2.0	2.0	2.0	2.0	2.0		
H TOOL STEELS A2, D2, H13, L2, M2, P20, S7, T15, W2	≤ 200 Bhn or ≤ 13 HRc	130	RPM	15891	3973	1986	1324	993	795	568	
		(104-156)	Fr	0.0007	0.0026	0.0053	0.0079	0.0106	0.0132	0.0185	
			Feed (ipm)	10.5	10.5	10.5	10.5	10.5	10.5	10.5	
	≤ 375 Bhn or ≤ 40 HRc	90	RPM	11002	2750	1375	917	688	550	393	
		(72-108)	Fr	0.0003	0.0012	0.0023	0.0035	0.0047	0.0058	0.0081	
			Feed (ipm)	3.2	3.2	3.2	3.2	3.2	3.2	3.2	
	≤ 475 Bhn or ≤ 50 HRc	75	RPM	9168	2292	1146	764	573	458	327	
		(60-90)	Fr	0.0002	0.0008	0.0016	0.0024	0.0031	0.0039	0.0055	
			Feed (ipm)	1.8	1.8	1.8	1.8	1.8	1.8	1.8	

Bhn (Brinell) HRc (Rockwell C) HRb (Rockwell B)
 rpm = Vc x 3.82 / DC
 ipm = Fr x rpm
 reduce speed and feed for materials harder than listed
 refer to the SGS Tool Wizard® for complete technical information (www.kyocera-sgtool.com)

Series 135 3D Metric	Hardness	Vc (m/min)	DC • mm									
			1.5	3	6	8	10	12	16	20		
P CARBON STEELS 1018, 1040, 1080, 1090, 10L50, 1140, 1212, 12L15, 1525, 1536	≤ 175 Bhn or ≤ 7 HRc	117	RPM	24882	12441	6220	4665	3732	3110	2333	1866	
		(94-141)	Fr	0.047	0.094	0.189	0.252	0.315	0.378	0.504	0.630	
			Feed (mm/min)	1175	1175	1175	1175	1175	1175	1175	1175	1175
	≤ 275 Bhn or ≤ 28 HRc	107	RPM	22620	11310	5655	4241	3393	2827	2121	1696	
		(85-128)	Fr	0.043	0.086	0.172	0.229	0.286	0.343	0.457	0.572	
			Feed (mm/min)	970	970	970	970	970	970	970	970	970
	≤ 475 Bhn or ≤ 45 HRc	61	RPM	12926	6463	3231	2424	1939	1616	1212	969	
		(49-73)	Fr	0.036	0.071	0.142	0.190	0.237	0.285	0.380	0.475	
			Feed (mm/min)	460	460	460	460	460	460	460	460	460
	M ALLOY STEELS 4140, 4150, 4320, 5120, 5150, 8630, 86L20, 50100	≤ 275 Bhn or ≤ 28 HRc	91	RPM	19388	9694	4847	3635	2908	2424	1818	1454
			(73-110)	Fr	0.036	0.071	0.142	0.190	0.237	0.285	0.380	0.475
				Feed (mm/min)	690	690	690	690	690	690	690	690
≤ 375 Bhn or ≤ 40 HRc		56	RPM	11956	5978	2989	2242	1793	1495	1121	897	
		(45-68)	Fr	0.031	0.061	0.122	0.163	0.204	0.244	0.326	0.407	
			Feed (mm/min)	365	365	365	365	365	365	365	365	365
≤ 450 Bhn or ≤ 48 HRc		40	RPM	8402	4201	2100	1575	1260	1050	788	630	
		(32-48)	Fr	0.021	0.042	0.083	0.111	0.139	0.167	0.222	0.278	
			Feed (mm/min)	175	175	175	175	175	175	175	175	175
K STAINLESS STEELS (FREE MACHINING) 303, 416, 420F, 430F, 440F		≤ 185 Bhn or ≤ 9 HRc	84	RPM	17773	8886	4443	3332	2666	2222	1666	1333
			(67-101)	Fr	0.031	0.061	0.123	0.164	0.204	0.245	0.327	0.409
				Feed (mm/min)	545	545	545	545	545	545	545	545
	≤ 275 Bhn or ≤ 28 HRc	52	RPM	10987	5493	2747	2060	1648	1373	1030	824	
		(41-62)	Fr	0.024	0.047	0.095	0.126	0.158	0.189	0.252	0.316	
			Feed (mm/min)	260	260	260	260	260	260	260	260	260
	K STAINLESS STEELS (DIFFICULT) 304, 316, 321, 13-8 PH, 15-5PH, 17-4 PH, Custom 450	≤ 275 Bhn or ≤ 28 HRc	27	RPM	5816	2908	1454	1091	872	727	545	436
			(22-33)	Fr	0.023	0.046	0.093	0.124	0.155	0.186	0.248	0.309
				Feed (mm/min)	135	135	135	135	135	135	135	135
		≤ 375 Bhn or ≤ 40 HRc	20	RPM	4201	2100	1050	788	630	525	394	315
			(16-24)	Fr	0.020	0.040	0.081	0.108	0.135	0.162	0.216	0.270
				Feed (mm/min)	85	85	85	85	85	85	85	85
K CAST IRONS Gray, Malleable, Ductile		≤ 220 Bhn or ≤ 19 HRc	98	RPM	20681	10340	5170	3878	3102	2585	1939	1551
			(78-117)	Fr	0.055	0.110	0.220	0.293	0.366	0.439	0.585	0.732
				Feed (mm/min)	1135	1135	1135	1135	1135	1135	1135	1135
		≤ 260 Bhn or ≤ 26 HRc	87	RPM	18419	9209	4605	3454	2763	2302	1727	1381
			(69-104)	Fr	0.055	0.110	0.219	0.292	0.366	0.439	0.585	0.731
				Feed (mm/min)	1010	1010	1010	1010	1010	1010	1010	1010

continued on next page

Series 135 3D Metric	Hardness	Vc (m/min)	DC • mm									
			1.5	3	6	8	10	12	16	20		
N ALUMINUM ALLOYS 2017, 2024, 356, 6061, 7075	≤ 80 Bhn or ≤ 47 HRb	213	RPM	45239	22620	11310	8482	6786	5655	4241	3393	
		(171-256)	Fr	0.059	0.119	0.238	0.317	0.396	0.476	0.634	0.793	
			Feed (mm/min)	2690	2690	2690	2690	2690	2690	2690	2690	
	≤ 150 Bhn or ≤ 7 HRc	183	RPM	38777	19388	9694	7271	5816	4847	3635	2908	
		(146-219)	Fr	0.060	0.120	0.240	0.320	0.400	0.480	0.640	0.799	
			Feed (mm/min)	2325	2325	2325	2325	2325	2325	2325	2325	
	COPPER ALLOYS Alum Bronze, C110, Muntz Brass	≤ 140 Bhn or ≤ 3 HRc	152	RPM	32314	16157	8078	6059	4847	4039	3029	2424
			(122-183)	Fr	0.024	0.048	0.096	0.128	0.160	0.192	0.256	0.320
				Feed (mm/min)	776	776	776	776	776	776	776	776
		≤ 200 Bhn or ≤ 23 HRc	122	RPM	25851	12926	6463	4847	3878	3231	2424	1939
			(98-146)	Fr	0.024	0.049	0.097	0.130	0.162	0.195	0.260	0.325
				Feed (mm/min)	630	630	630	630	630	630	630	630
S SUPER ALLOYS (NICKEL, COBALT, IRON BASE) Inconel 601, 617, 625, Incoloy, Monel 400, Rene, Waspaloy	≤ 300 Bhn or ≤ 32 HRc	17	RPM	3555	1777	889	666	533	444	333	267	
		(13-20)	Fr	0.010	0.020	0.039	0.053	0.066	0.079	0.105	0.131	
			Feed (mm/min)	35	35	35	35	35	35	35	35	
	≤ 400 Bhn or ≤ 43 HRc	9	RPM	1939	969	485	364	291	242	182	145	
		(7-11)	Fr	0.008	0.015	0.031	0.041	0.052	0.062	0.083	0.103	
			Feed (mm/min)	15	15	15	15	15	15	15	15	
	TITANIUM ALLOYS Pure Titanium, Ti6Al4V, Ti6Al2Sn4Zr2Mo, Ti4Al4Mo2Sn0.5Si, Ti-6Al4V	≤ 275 Bhn or ≤ 28 HRc	41	RPM	8725	4362	2181	1636	1309	1091	818	654
			(33-49)	Fr	0.021	0.042	0.085	0.113	0.141	0.170	0.226	0.283
				Feed (mm/min)	185	185	185	185	185	185	185	185
		≤ 350 Bhn or ≤ 38 HRc	30	RPM	6463	3231	1616	1212	969	808	606	485
			(24-37)	Fr	0.019	0.039	0.077	0.103	0.129	0.155	0.206	0.258
				Feed (mm/min)	125	125	125	125	125	125	125	125
≤ 440 Bhn or ≤ 47 HRc	17	RPM	3555	1777	889	666	533	444	333	267		
	(13-20)	Fr	0.014	0.028	0.056	0.075	0.094	0.113	0.150	0.188		
		Feed (mm/min)	50	50	50	50	50	50	50	50		
H TOOL STEELS A2, D2, H13, L2, M2, P20, S7, T15, W2	≤ 200 Bhn or ≤ 13 HRc	40	RPM	8402	4201	2100	1575	1260	1050	788	630	
		(32-48)	Fr	0.032	0.063	0.126	0.168	0.210	0.252	0.336	0.421	
			Feed (mm/min)	265	265	265	265	265	265	265	265	
	≤ 375 Bhn or ≤ 40 HRc	27	RPM	5816	2908	1454	1091	872	727	545	436	
		(22-33)	Fr	0.014	0.028	0.055	0.073	0.092	0.110	0.147	0.183	
			Feed (mm/min)	80	80	80	80	80	80	80	80	
	≤ 475 Bhn or ≤ 50 HRc	23	RPM	4847	2424	1212	909	727	606	454	364	
		(18-27)	Fr	0.009	0.019	0.037	0.050	0.062	0.074	0.099	0.124	
			Feed (mm/min)	45	45	45	45	45	45	45	45	

Bhn (Brinell) HRc (Rockwell C) HRb (Rockwell B)
 $rpm = (Vc \times 1000) / (DC \times 3.14)$
 $mm/min = Fr \times rpm$
 reduce speed and feed for materials harder than listed
 refer to the SGS Tool Wizard® for complete technical information (www.kyocera-sgstool.com)

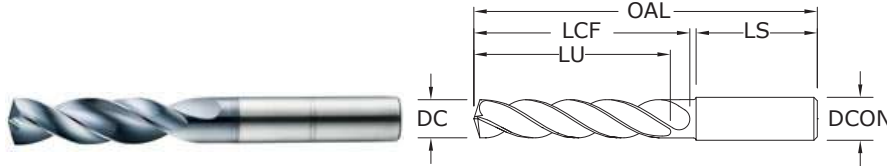

135 5xD

FRACTIONAL & METRIC SERIES

- Double margin design improves accuracy and surface finish along with increased strength for aggressive drilling
- Specialized self-centering notched point eliminates the need for spot drilling decreasing thrust and deflection
- Engineered edge protection improves edge strength and reduces edge fatigue allowing for increased feed rates
- Recommended for materials ≤ 56 HRc (≤ 577 Bhn)

CUTTING DIAMETER DC	DECIMAL EQUIV.	METRIC EQUIV.	TAP SIZE REFERENCE ONLY	inch & mm					Ti-NAMITE-A (AlTiN)	EDP NO.
				SHANK DIAMETER DCON	OVERALL LENGTH OAL	FLUTE LENGTH LCF	CLEARED LENGTH LU	SHANK LENGTH LS		
1/64	0.0156	0.40		1/8	1 1/2	5/32	7/64	1	52300*	
1/32	0.0312	0.79		1/8	1 1/2	5/16	7/32	1	52301*	
3/64	0.0469	1.19	1/16-64	1/8	1 1/2	25/64	19/64	1	52302*	
1,25 mm	0.0492			3,0	38,0	10,0	7,5	25,0	64520*	
1,45 mm	0.0571			3,0	38,0	10,0	7,5	25,0	64521*	
#53	0.0595	1.51		1/8	1-1/2	25/64	19/64	1	64522*	
1/16	0.0625	1.59	5/64-60	1/8	2	15/32	23/64	1-1/4	52303*	
1,6 mm	0.0630			3,0	50,0	12,0	9,0	32,0	64523*	
1,75 mm	0.0689			3,0	50,0	12,0	9,0	32,0	64524*	
#50	0.0700	1.78		1/8	2	15/32	23/64	1-1/4	64525*	
5/64	0.0781	1.98		1/8	2	35/64	27/64	1-1/4	52304*	
#47	0.0785	1.99		1/8	2	35/64	27/64	1-1/4	64526*	
2,05 mm	0.0807			3,0	50,0	14,0	11,0	32,0	64527*	
#46	0.0810	2.06		1/8	2	35/64	27/64	1-1/4	64528*	
#43	0.0890	2.26		1/8	2	19/32	15/32	1-1/4	64529*	
#42	0.0935	2.37		1/8	2	5/8	1/2	1-1/4	64530*	
3/32	0.0938	2.38	1/8-32	1/8	2	5/8	1/2	1-1/4	52305	
#40	0.0980	2.49		1/8	2	43/64	17/32	1-1/4	52306	
2,5 mm	0.0984			3,0	50,0	17,0	13,0	32,0	64531	
#39	0.0995	2.53		1/8	2	43/64	17/32	1-1/4	52307	
#38	0.1015	2.58	5-40	1/8	2	43/64	17/32	1-1/4	52308	
#37	0.1040	2.64	5-44	1/8	2	45/64	9/16	1-1/4	52309	
#36	0.1065	2.71	6-32	1/8	2	45/64	9/16	1-1/4	52310	
7/64	0.1094	2.78		1/8	2	3/4	19/32	1-1/4	52311	
#35	0.1100	2.79		1/8	2	3/4	19/32	1-1/4	52312	
#34	0.1110	2.82		1/8	2	3/4	19/32	1-1/4	52313	
#33	0.1130	2.87	6-40	1/8	2	3/4	19/32	1-1/4	52314	
2,9 mm	0.1142			3,0	50,0	19,0	15,0	32,0	64532	
#32	0.1160	2.95		1/8	2	3/4	39/64	1-1/4	52315	
3,0 mm	0.1181			6,0	66,0	28,0	23,0	36,0	64100	
#31	0.1200	3.05		1/8	2	3/4	39/64	1-1/4	52316	
3,1 mm	0.1220			6,0	66,0	28,0	23,0	36,0	64101	
1/8	0.1250	3.18		1/4	3	1	53/64	1-7/16	51580	
3,2 mm	0.1260		M3,5 X 0,35	6,0	66,0	28,0	23,0	36,0	64102	
#30	0.1285	3.26		1/4	3	1	53/64	1-7/16	51581	
3,3 mm	0.1299		M4 X 0,7	6,0	66,0	28,0	23,0	36,0	64103	
3,4 mm	0.1339		8-32,8-36	6,0	66,0	28,0	23,0	36,0	64104	
#29	0.1360	3.45		1/4	3	1	53/64	1-7/16	51582	

*Single Margin

continued on next page

TOLERANCES (inch)

$\leq .1181$ DIAMETER
DC = $+0.0008/+0.00047$
DCON = h_6

$>.1181-.2362$ DIAMETER
DC = $+0.0016/+0.00063$
DCON = h_6

$>.2362-.3937$ DIAMETER
DC = $+0.0024/+0.00083$
DCON = h_6

$>.3937-.7087$ DIAMETER
DC = $+0.0028/+0.00098$
DCON = h_6

$>.7087-1.1811$ DIAMETER
DC = $+0.0031/+0.0114$
DCON = h_6

TOLERANCES (mm)

≤ 3 DIAMETER
DC = $+0,002/+0,012$
DCON = h_6

$>3-6$ DIAMETER
DC = $+0,004/+0,016$
DCON = h_6

$>6-10$ DIAMETER
DC = $+0,006/+0,021$
DCON = h_6

$>10-18$ DIAMETER
DC = $+0,007/+0,025$
DCON = h_6

$>18-30$ DIAMETER
DC = $+0,008/+0,029$
DCON = h_6

- STEELS
- STAINLESS STEELS
- CAST IRON
- HIGH TEMP ALLOYS
- TITANIUM
- NON-FERROUS
- HARDENED STEELS

For patent information visit www.ksptpatents.com



135 5xD
FRACTIONAL & METRIC SERIES

inch & mm									EDP NO.
CUTTING DIAMETER DC	DECIMAL EQUIV.	METRIC EQUIV.	TAP SIZE REFERENCE ONLY	SHANK DIAMETER DCON	OVERALL LENGTH OAL	FLUTE LENGTH LCF	CLEARED LENGTH LU	SHANK LENGTH LS	Ti-NAMITE-A (AITiN)
3,5 mm	0.1378			6,0	66,0	28,0	23,0	36,0	64105
#28	0.1405	3.57	8-40	1/4	3	1	53/64	1- 7/16	52317
9/64	0.1406	3.57		1/4	3	1	53/64	1-7/16	51583
3,6 mm	0.1417		M4 X 0,35	6,0	66,0	28,0	23,0	36,0	64106
#27	0.1440	3.66		1/4	3	1	53/64	1-7/16	52318
3,7 mm	0.1457		M4,5 X 0,75	6,0	66,0	28,0	23,0	36,0	64107
#26	0.1470	3.73	3/16-24	1/4	3	1	53/64	1-7/16	52319
#25	0.1495	3.80	10-24	1/4	3-1/4	1-1/4	1-5/64	1-7/16	51584
3,8 mm	0.1496			6,0	74,0	36,0	29,0	36,0	64108
#24	0.1520	3.86	10-28	1/4	3-1/4	1-1/4	1-5/64	1-7/16	52321
3,9 mm	0.1535			6,0	74,0	36,0	29,0	36,0	64109
#23	0.1540	3.91		1/4	3-1/4	1-1/4	1-5/64	1-7/16	52322
5/32	0.1562	3.97		1/4	3-1/4	1-1/4	1-5/64	1-7/16	51585
#22	0.1570	3.99	10-30	1/4	3-1/4	1-1/4	1-5/64	1-7/16	52323
4,0 mm	0.1575		M4,5 X 0,5	6,0	74,0	36,0	29,0	36,0	64110
#21	0.1590	4.04	10-32	1/4	3-1/4	1-1/4	1-5/64	1-7/16	51586
#20	0.1610	4.09	13/64-24	1/4	3-1/4	1-1/4	1-5/64	1-7/16	51587
4,1 mm	0.1614			6,0	74,0	36,0	29,0	36,0	64111
4,2 mm	0.1654		M5 / M5 X 0,75	6,0	74,0	36,0	29,0	36,0	64112
#19	0.1660	4.22		1/4	3-1/4	1-1/4	1-5/64	1-7/16	52324
4,3 mm	0.1693			6,0	74,0	36,0	29,0	36,0	64113
#18	0.1695	4.31		1/4	3-1/4	1-1/4	1-5/64	1-7/16	52325
11/64	0.1719	4.37		1/4	3-1/4	1-1/4	1-5/64	1-7/16	51588
#17	0.1730	4.39		1/4	3-1/4	1-1/4	1-5/64	1-7/16	52326
4,4 mm	0.1732			6,0	74,0	36,0	29,0	36,0	64114
4,5 mm	0.1772		M5 X 0,5	6,0	74,0	36,0	29,0	36,0	64115
#15	0.1800	4.57		1/4	3-1/4	1-1/4	1-5/64	1-7/16	52327
4,6 mm	0.1811		12-28	6,0	74,0	36,0	29,0	36,0	64116
#14	0.1820	4.62		1/4	3-1/4	1-1/4	1-5/64	1-7/16	52328
#13	0.1850	4.70	12-32	1/4	3-1/4	1-1/4	1-5/64	1-7/16	52329
4,7 mm	0.1850			6,0	74,0	36,0	29,0	36,0	64117
3/16	0.1875	4.76		1/4	3-1/4	1-3/4	1-37/64	1-7/16	51589
#12	0.1890	4.80	7/32-32	1/4	3-1/4	1-3/4	1-37/64	1-7/16	52330
4,8 mm	0.1890			6,0	82,0	44,0	35,0	36,0	64118
4,9 mm	0.1929			6,0	82,0	44,0	35,0	36,0	64119
#10	0.1935	4.91	14-20	1/4	3-1/4	1-3/4	1-37/64	1-7/16	52331
#9	0.1960	4.98		1/4	3-1/4	1-3/4	1-37/64	1-7/16	52332
5,0 mm	0.1969		M6 X 1	6,0	82,0	44,0	35,0	36,0	64120
#8	0.1990	5.05		1/4	3-1/4	1-3/4	1-37/64	1-7/16	52333
5,1 mm	0.2008			6,0	82,0	44,0	35,0	36,0	64121
#7	0.2010	5.11	1/4-20	1/4	3-1/4	1-3/4	1-37/64	1-7/16	51506
13/64	0.2031	5.16		1/4	3-1/4	1-3/4	1-37/64	1-7/16	51507
#6	0.2040	5.18		1/4	3 1/4	1 3/4	1 37/64	1 7/16	52334
5,2 mm	0.2047		M6 X 0,75	6,0	82,0	44,0	35,0	36,0	64122
#5	0.2055	5.22		1/4	3-1/4	1-3/4	1-37/64	1-7/16	51590
5,25 mm	0.2067			6,0	82,0	44,0	35,0	36,0	64123
5,3 mm	0.2087			6,0	82,0	44,0	35,0	36,0	64124
#4	0.2090	5.31	1/4-24	1/4	3-1/4	1-3/4	1-37/64	1-7/16	51508

CONTINUED

continued on next page

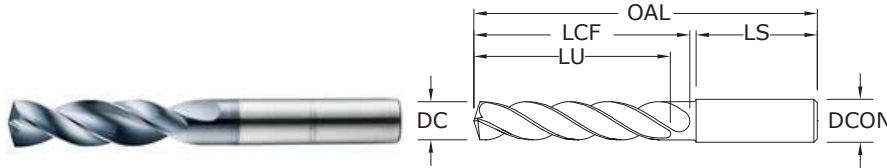

135 5xD

FRACTIONAL & METRIC SERIES

- Double margin design improves accuracy and surface finish along with increased strength for aggressive drilling
- Specialized self-centering notched point eliminates the need for spot drilling decreasing thrust and deflection
- Engineered edge protection improves edge strength and reduces edge fatigue allowing for increased feed rates
- Recommended for materials ≤ 56 HRc (≤ 577 Bhn)

CUTTING DIAMETER DC	DECIMAL EQUIV.	METRIC EQUIV.	TAP SIZE REFERENCE ONLY	inch & mm					EDP NO.	Ti-NAMITE-A (AITiN)
				SHANK DIAMETER DCON	OVERALL LENGTH OAL	FLUTE LENGTH LCF	CLEARED LENGTH LU	SHANK LENGTH LS		
5,4 mm	0.2126			6,0	82,0	44,0	35,0	36,0	64125	
#3	0.2130	5.41	1/4-28	1/4	3-1/4	1-3/4	1-37/64	1-7/16	51509	
5,5 mm	0.2165		M6 X 0,5	6,0	82,0	44,0	35,0	36,0	64126	
7/32	0.2188	5.56	1/4-32	1/4	3-1/4	1-3/4	1-37/64	1-7/16	51510	
5,6 mm	0.2205			6,0	82,0	44,0	35,0	36,0	64127	
#2	0.2210	5.61		1/4	3-1/4	1-3/4	1-37/64	1-7/16	52335	
5,7 mm	0.2244			6,0	82,0	44,0	35,0	36,0	64128	
#1	0.2280	5.79		1/4	3-1/4	1-3/4	1-37/64	1-7/16	52336	
5,8 mm	0.2283			6,0	82,0	44,0	35,0	36,0	64129	
5,9 mm	0.2323			6,0	82,0	44,0	35,0	36,0	64130	
A	0.2340	5.94		1/4	3-1/4	1-3/4	1-37/64	1-7/16	52337	
15/64	0.2344	5.95		1/4	3-1/4	1-3/4	1-37/64	1-7/16	51591	
6,0 mm	0.2362		M7 X 1	6,0	82,0	44,0	35,0	36,0	64131	
B	0.2380	6.05		1/4	3 5/8	2-5/64	1-51/64	1-7/16	52338	
6,1 mm	0.2402			8,0	91,0	53,0	43,0	36,0	64132	
C	0.2420	6.15		1/4	3 5/8	2-5/64	1-51/64	1-7/16	52339	
6,2 mm	0.2441			8,0	91,0	53,0	43,0	36,0	64133	
D	0.2460	6.25		1/4	3 5/8	2-5/64	1-51/64	1-7/16	52340	
6,25 mm	0.2461		M7 X 0,75	8,0	91,0	53,0	43,0	36,0	64134	
6,3 mm	0.2480			8,0	91,0	53,0	43,0	36,0	64135	
1/4	0.2500	6.35		1/4	3-5/8	2-5/64	1-51/64	1-7/16	51511	
6,4 mm	0.2520			8,0	91,0	53,0	43,0	36,0	64136	
6,5 mm	0.2559			8,0	91,0	53,0	43,0	36,0	64137	
F	0.2570	6.53	5/16-18	5/16	3-5/8	2-5/64	1-51/64	1-7/16	51512	
6,6 mm	0.2598			8,0	91,0	53,0	43,0	36,0	64138	
G	0.2610	6.63		5/16	3 5/8	2 5/64	1 51/64	1 7/16	52341	
6,7 mm	0.2638			8,0	91,0	53,0	43,0	36,0	64139	
17/64	0.2656	6.75	5/16-20	5/16	3-5/8	2-5/64	1-51/64	1-7/16	51513	
H	0.2660	6.76		5/16	3-5/8	2-5/64	1-51/64	1-7/16	52342	
6,8 mm	0.2677		M8 X 1,25	8,0	91,0	53,0	43,0	36,0	64140	
6,9 mm	0.2717			8,0	91,0	53,0	43,0	36,0	64141	
I	0.2720	6.91	5/16-24	5/16	3-5/8	2-5/64	1-51/64	1-7/16	51514	
7,0 mm	0.2756		M8 X 1	8,0	91,0	53,0	43,0	36,0	64142	
J	0.2770	7.04		5/16	3 5/8	2-5/64	1-51/64	1-7/16	52343	
7,1 mm	0.2795			8,0	91,0	53,0	43,0	36,0	64143	
K	0.2810	7.14		5/16	3 5/8	2-5/64	1-51/64	1-7/16	52344	
9/32	0.2812	7.14	5/16-32	5/16	3-5/8	2-5/64	1-51/64	1-7/16	51515	
7,2 mm	0.2835			8,0	91,0	53,0	43,0	36,0	64144	

TOLERANCES (inch)

$\leq .1181$ DIAMETER
DC = +.00008/+0.00047
DCON = h_6

>.1181-.2362 DIAMETER
DC = +.00016/+0.00063
DCON = h_6

>.2362-.3937 DIAMETER
DC = +.00024/+0.00083
DCON = h_6

>.3937-.7087 DIAMETER
DC = +.00028/+0.00098
DCON = h_6

>.7087-1.1811 DIAMETER
DC = +.00031/+0.00114
DCON = h_6

TOLERANCES (mm)

≤ 3 DIAMETER
DC = +0,002/+0,012
DCON = h_6

>3-6 DIAMETER
DC = +0,004/+0,016
DCON = h_6

>6-10 DIAMETER
DC = +0,006/+0,021
DCON = h_6

>10-18 DIAMETER
DC = +0,007/+0,025
DCON = h_6

>18-30 DIAMETER
DC = +0,008/+0,029
DCON = h_6

- STEELS
- STAINLESS STEELS
- CAST IRON
- HIGH TEMP ALLOYS
- TITANIUM
- NON-FERROUS
- HARDENED STEELS

continued on next page

For patent information visit www.ksptpatents.com



135 5xD
FRACTIONAL & METRIC SERIES

inch & mm									EDP NO.
CUTTING DIAMETER DC	DECIMAL EQUIV.	METRIC EQUIV.	TAP SIZE REFERENCE ONLY	SHANK DIAMETER DCON	OVERALL LENGTH OAL	FLUTE LENGTH LCF	CLEARED LENGTH LU	SHANK LENGTH LS	Ti-NAMITE-A (AITiN)
7,25 mm	0.2854		M8 X 0,75	8,0	91,0	53,0	43,0	36,0	64145
7,3 mm	0.2874			8,0	91,0	53,0	43,0	36,0	64146
L	0.2900	7.37		5/16	3-5/8	2-5/64	1-51/64	1-7/16	52345
7,4 mm	0.2913			8,0	91,0	53,0	43,0	36,0	64147
M	0.2950	7.49		5/16	3-5/8	2-5/64	1-51/64	1-7/16	52346
7,5 mm	0.2953		M8 X 0,5	8,0	91,0	53,0	43,0	36,0	64148
19/64	0.2969	7.54		5/16	3-5/8	2-5/64	1-51/64	1-7/16	51516
7,6 mm	0.2992			8,0	91,0	53,0	43,0	36,0	64149
N	0.3020	7.67		5/16	3-5/8	2-5/64	1-51/64	1-7/16	52347
7,7 mm	0.3031			8,0	91,0	53,0	43,0	36,0	64150
7,8 mm	0.3071		M9 X 1,25	8,0	91,0	53,0	43,0	36,0	64151
7,9 mm	0.3110			8,0	91,0	53,0	43,0	36,0	64152
5/16	0.3125	7.94	3/8-16	5/16	3-5/8	2-5/64	1-51/64	1-7/16	51517
8,0 mm	0.3150		M9 X 1	8,0	91,0	53,0	43,0	36,0	64153
O	0.3160	8.03		3/8	4	2-13/32	2-1/8	1-9/16	52348
8,1 mm	0.3189			10,0	103,0	61,0	49,0	40,0	64154
8,2 mm	0.3228			10,0	103,0	61,0	49,0	40,0	64155
P	0.3230	8.20		3/8	4	2-13/32	2-1/8	1-9/16	51518
8,3 mm	0.3268			10,0	103,0	61,0	49,0	40,0	64156
21/64	0.3281	8.33	3/8-20	3/8	4	2-13/32	2-1/8	1-9/16	51519
8,4 mm	0.3307			10,0	103,0	61,0	49,0	40,0	64157
Q	0.3320	8.43	3/8-24	3/8	4	2-13/32	2-1/8	1-9/16	51520
8,5 mm	0.3346		M10 X 1,5	10,0	103,0	61,0	49,0	40,0	64158
8,6 mm	0.3386			10,0	103,0	61,0	49,0	40,0	64159
R	0.3390	8.61	3/8-32	3/8	4	2-13/32	2-1/8	1-9/16	52349
8,7 mm	0.3425		M10 X 1,25	10,0	103,0	61,0	49,0	40,0	64160
11/32	0.3438	8.73		3/8	4	2-13/32	2-1/8	1-9/16	51521
8,8 mm	0.3465			10,0	103,0	61,0	49,0	40,0	64161
S	0.3480	8.84		3/8	4	2-13/32	2-1/8	1-9/16	51522
8,9 mm	0.3504			10,0	103,0	61,0	49,0	40,0	64162
9,0 mm	0.3543		M10 X 1	10,0	103,0	61,0	49,0	40,0	64163
T	0.3580	9.09		3/8	4	2 13/32	2 1/8	1 9/16	52350
9,1 mm	0.3583			10,0	103,0	61,0	49,0	40,0	64164
23/64	0.3594	9.13		3/8	4	2-13/32	2-1/8	1-9/16	51523
9,2 mm	0.3622		M10 X 0,75	10,0	103,0	61,0	49,0	40,0	64165
9,25 mm	0.3642			10,0	103,0	61,0	49,0	40,0	64166
9,3 mm	0.3661			10,0	103,0	61,0	49,0	40,0	64167
U	0.3680	9.35	7/16-14	3/8	4	2-13/32	2-1/8	1-9/16	51524
9,4 mm	0.3701			10,0	103,0	61,0	49,0	40,0	64168
9,5 mm	0.3740		M10 X 0,5	10,0	103,0	61,0	49,0	40,0	64169
3/8	0.3750	9.53		3/8	4	2-13/32	2-1/8	1-9/16	51525
V	0.3770	9.58		1/2	4	2-13/32	2-1/8	1-9/16	52351
9,6 mm	0.3780			10,0	103,0	61,0	49,0	40,0	64170
9,7 mm	0.3819			10,0	103,0	61,0	49,0	40,0	64171
9,8 mm	0.3858			10,0	103,0	61,0	49,0	40,0	64172
W	0.3860	9.80		1/2	4	2-13/32	2-1/8	1-9/16	51526
9,9 mm	0.3898			10,0	103,0	61,0	49,0	40,0	64173
25/64	0.3906	9.92	7/16-20	1/2	4	2-13/32	2-1/8	1-9/16	51527

CONTINUED

continued on next page

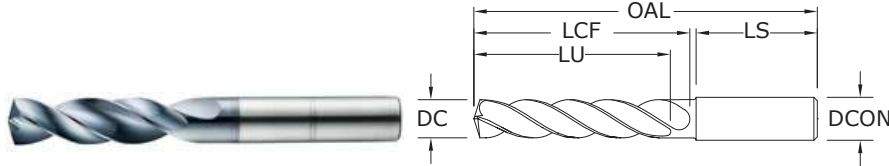

135 5xD

FRACTIONAL & METRIC SERIES

- Double margin design improves accuracy and surface finish along with increased strength for aggressive drilling
- Specialized self-centering notched point eliminates the need for spot drilling decreasing thrust and deflection
- Engineered edge protection improves edge strength and reduces edge fatigue allowing for increased feed rates
- Recommended for materials ≤ 56 HRc (≤ 577 Bhn)

CUTTING DIAMETER DC	DECIMAL EQUIV.	METRIC EQUIV.	TAP SIZE REFERENCE ONLY	inch & mm					EDP NO.	Ti-NAMITE-A (AITiN)
				SHANK DIAMETER DCON	OVERALL LENGTH OAL	FLUTE LENGTH LCF	CLEARED LENGTH LU	SHANK LENGTH LS		
10,0 mm	0.3937			10,0	103,0	61,0	49,0	40,0	64174	
X	0.3970	10.08	7/16-24	1/2	4-11/16	2-3/4	2-23/64	1-49/64	52352	
10,1 mm	0.3976			12,0	118,0	71,0	56,0	45,0	64175	
10,2 mm	0.4016			12,0	118,0	71,0	56,0	45,0	64176	
Y	0.4040	10.26	7/16-28	1/2	4-11/16	2-3/4	2-23/64	1-49/64	52353	
10,3 mm	0.4055			12,0	118,0	71,0	56,0	45,0	64177	
13/32	0.4062	10.32		1/2	4-11/16	2-3/4	2-23/64	1-49/64	51528	
10,4 mm	0.4095			12,0	118,0	71,0	56,0	45,0	64178	
Z	0.4130	10.49		1/2	4-11/16	2-3/4	2-23/64	1-49/64	52354	
10,5 mm	0.4134		M12 X 1,5	12,0	118,0	71,0	56,0	45,0	64179	
10,6 mm	0.4173			12,0	118,0	71,0	56,0	45,0	64180	
10,7 mm	0.4213			12,0	118,0	71,0	56,0	45,0	64181	
27/64	0.4219	10.72	1/2-13	1/2	4-11/16	2-3/4	2-23/64	1-49/64	51529	
10,8 mm	0.4252		M12 X 1,25	12,0	118,0	71,0	56,0	45,0	64182	
10,9 mm	0.4291			12,0	118,0	71,0	56,0	45,0	64183	
11,0 mm	0.4331			12,0	118,0	71,0	56,0	45,0	64184	
11,1 mm	0.4370		M12 X 1	12,0	118,0	71,0	56,0	45,0	64185	
7/16	0.4375	11.11	1/4-18 NPT	1/2	4-11/16	2-3/4	2-23/64	1-49/64	51530	
11,2 mm	0.4409			12,0	118,0	71,0	56,0	45,0	64186	
11,25 mm	0.4429			12,0	118,0	71,0	56,0	45,0	64187	
11,3 mm	0.4449			12,0	118,0	71,0	56,0	45,0	64188	
11,4 mm	0.4488			12,0	118,0	71,0	56,0	45,0	64189	
11,5 mm	0.4528		M12 X 0,5	12,0	118,0	71,0	56,0	45,0	64190	
29/64	0.4531	11.51	1/2-20	1/2	4-11/16	2-3/4	2-23/64	1-49/64	51531	
11,6 mm	0.4567			12,0	118,0	71,0	56,0	45,0	64191	
11,7 mm	0.4606			12,0	118,0	71,0	56,0	45,0	64192	
11,8 mm	0.4646			12,0	118,0	71,0	56,0	45,0	64193	
11,9 mm	0.4685			12,0	118,0	71,0	56,0	45,0	64194	
15/32	0.4688	11.91	1/2-28	1/2	4-11/16	2-3/4	2-23/64	1-49/64	51532	
12,0 mm	0.4724		M14 X 2	12,0	118,0	71,0	56,0	45,0	64195	
31/64	0.4844	12.30	9/16-12	1/2	4-7/8	3-1/32	2-19/32	1-49/64	51533	
12,5 mm	0.4921		M14 X 1,5	14,0	124,0	77,0	60,0	45,0	64196	
1/2	0.5000	12.70		1/2	4-7/8	3-1/32	2-19/32	1-49/64	51534	
12,8 mm	0.5039		M14 X 1,25	14,0	124,0	77,0	60,0	45,0	64197	
13,0 mm	0.5118		M14 X 1	14,0	124,0	77,0	60,0	45,0	64198	
33/64	0.5156	13.10	9/16-18	5/8	4-7/8	3-1/32	2-19/32	1-49/64	51535	
17/32	0.5312	13.49	5/8-11	5/8	4-7/8	3-1/32	2-19/32	1-49/64	51536	
13,5 mm	0.5315			14,0	124,0	77,0	60,0	45,0	64199	

TOLERANCES (inch)

$\leq .1181$ DIAMETER
DC = $+0.0008/+0.00047$
DCON = h_6

$>.1181-.2362$ DIAMETER
DC = $+0.0016/+0.00063$
DCON = h_6

$>.2362-.3937$ DIAMETER
DC = $+0.0024/+0.00083$
DCON = h_6

$>.3937-.7087$ DIAMETER
DC = $+0.0028/+0.00098$
DCON = h_6

$>.7087-1.1811$ DIAMETER
DC = $+0.0031/+0.0114$
DCON = h_6

TOLERANCES (mm)

≤ 3 DIAMETER
DC = $+0,002/+0,012$
DCON = h_6

$>3-6$ DIAMETER
DC = $+0,004/+0,016$
DCON = h_6

$>6-10$ DIAMETER
DC = $+0,006/+0,021$
DCON = h_6

$>10-18$ DIAMETER
DC = $+0,007/+0,025$
DCON = h_6

$>18-30$ DIAMETER
DC = $+0,008/+0,029$
DCON = h_6

- STEELS
- STAINLESS STEELS
- CAST IRON
- HIGH TEMP ALLOYS
- TITANIUM
- NON-FERROUS
- HARDENED STEELS

For patent information visit www.ksptools.com

continued on next page



135 5xD

FRACTIONAL & METRIC SERIES

inch & mm									EDP NO.
CUTTING DIAMETER DC	DECIMAL EQUIV.	METRIC EQUIV.	TAP SIZE REFERENCE ONLY	SHANK DIAMETER DCON	OVERALL LENGTH OAL	FLUTE LENGTH LCF	CLEARED LENGTH LU	SHANK LENGTH LS	Ti-NAMITE-A (AITiN)
35/64	0.5469	13.89	5/8-12	5/8	4-7/8	3-1/32	2-19/32	1-49/64	51537
14,0 mm	0.5512		M16 X 2	14,0	124,0	77,0	60,0	45,0	64200
9/16	0.5625	14.29		5/8	5-1/4	3-1/4	2-3/4	1-57/64	51538
14,5 mm	0.5709		M16 X 1,5	16,0	133,0	83,0	63,0	48,0	64201
37/64	0.5781	14.68	5/8-18	5/8	5-1/4	3-1/4	2-3/4	1-57/64	51539
15,0 mm	0.5906		M16 X 1	16,0	133,0	83,0	63,0	48,0	64202
19/32	0.5938	15.08	11/16-11	5/8	5-1/4	3-1/4	2-3/4	1-57/64	51592
39/64	0.6094	15.48	11/16-12	5/8	5-1/4	3-1/4	2-3/4	1-57/64	51593
15,5 mm	0.6102		M18 X 2,5	16,0	133,0	83,0	63,0	48,0	64203
5/8	0.6250	15.88	11/16-16	5/8	5-1/4	3-1/4	2-3/4	1-57/64	51540
16,0 mm	0.6299			16,0	133,0	83,0	63,0	48,0	64204
41/64	0.6406	16.27	11/16-24	3/4	5-5/8	3-5/8	3-3/16	1-57/64	51594
16,5 mm	0.6496		M18 X 1,5	18,0	143,0	93,0	71,0	48,0	64205
21/32	0.6562	16.67	3/4-10	3/4	5-5/8	3-5/8	3-3/16	1-57/64	51541
17,0 mm	0.6693			18,0	143,0	93,0	71,0	48,0	64206
43/64	0.6719	17.07	3/4-12	3/4	5-5/8	3-5/8	3-3/16	1-57/64	51595
11/16	0.6875	17.46	3/4-16	3/4	5-5/8	3-5/8	3-3/16	1-57/64	51542
17,5 mm	0.6890		M20 X 2,5	18,0	143,0	93,0	71,0	48,0	64207
45/64	0.7031	17.86	3/4-20, 1/2-14 NPT	3/4	5-5/8	3-5/8	3-3/16	1-57/64	51543
18,0 mm	0.7087			18,0	143,0	93,0	71,0	48,0	64208
23/32	0.7188	18.26		3/4	6	4	3-3/8	1-31/32	51596
18,5 mm	0.7283		M20 X 1,5	20,0	153,0	101,0	77,0	50,0	64209
47/64	0.7344	18.65	13/16-12	3/4	6	4	3-3/8	1-31/32	51544
19,0 mm	0.7480			20,0	153,0	101,0	77,0	50,0	64210
3/4	0.7500	19.05	13/16-16	3/4	6	4	3-3/8	1-31/32	51545
49/64	0.7656	19.45	7/8-9	7/8	6	4	3-3/8	1-31/32	52355
19,5 mm	0.7677		M22 X 2,5	20,0	153,0	101,0	77,0	50,0	64211
25/32	0.7812	19.84		7/8	6	4	3-3/8	1-31/32	52356
20,0 mm	0.7874			20,0	153,0	101,0	77,0	50,0	64212
51/64	0.7969	20.24	7/8-12	7/8	6	4	3-3/8	1-31/32	52357
20,5 mm	0.8071			22,0	153,0	101,0	77,0	50,0	64533
13/16	0.8125	20.64	7/8-14	7/8	6-1/2	4-1/2	3-7/8	1-31/32	52358
21,0 mm	0.8268			22,0	153,0	101,0	77,0	50,0	64534
22,0 mm	0.8661			22,0	178,0	127,0	108,0	50,0	64535
7/8	0.8750	22.23	15/16-16, 1-8	7/8	6-1/2	4-1/2	3-7/8	1-31/32	52359
59/64	0.9219	23.42	1-12	1	7	5	4-3/8	2-1/8	52360

CONTINUED

FRACTIONAL
Hi-PerCarb®

Series 135 5D Fractional	Hardness	Vc (sfm)		DC • in							
				1/32	1/8	1/4	3/8	1/2	5/8	7/8	
P CARBON STEELS 1018, 1040, 1080, 1090, 10L50, 1140, 1212, 12L15, 1525, 1536	≤ 175 Bhn or ≤ 7 HRc	345 (276-414)	RPM	42173	10543	5272	3514	2636	2109	1506	
			Fr	0.0010	0.0040	0.0080	0.0120	0.0159	0.0199	0.0279	
			Feed (ipm)	42.0	42.0	42.0	42.0	42.0	42.0	42.0	
	≤ 275 Bhn or ≤ 28 HRc	310 (248-372)	RPM	37894	9474	4737	3158	2368	1895	1353	
			Fr	0.0009	0.0036	0.0072	0.0108	0.0144	0.0179	0.0251	
			Feed (ipm)	34.0	34.0	34.0	34.0	34.0	34.0	34.0	
	≤ 425 Bhn or ≤ 45 HRc	180 (144-216)	RPM	22003	5501	2750	1834	1375	1100	786	
			Fr	0.0007	0.0030	0.0060	0.0090	0.0120	0.0150	0.0210	
			Feed (ipm)	16.5	16.5	16.5	16.5	16.5	16.5	16.5	
	M ALLOY STEELS 4140, 4150, 4320, 5120, 5150, 8630, 86L20, 50100	≤ 275 Bhn or ≤ 28 HRc	270 (216-324)	RPM	33005	8251	4126	2750	2063	1650	1179
				Fr	0.0008	0.0030	0.0061	0.0091	0.0121	0.0151	0.0212
				Feed (ipm)	25.0	25.0	25.0	25.0	25.0	25.0	25.0
≤ 375 Bhn or ≤ 40 HRc		165 (132-198)	RPM	20170	5042	2521	1681	1261	1008	720	
			Fr	0.0006	0.0026	0.0052	0.0077	0.0103	0.0129	0.0180	
			Feed (ipm)	13.0	13.0	13.0	13.0	13.0	13.0	13.0	
≤ 450 Bhn or ≤ 48 HRc		115 (92-138)	RPM	14058	3514	1757	1171	879	703	502	
			Fr	0.0004	0.0018	0.0035	0.0053	0.0071	0.0088	0.0123	
			Feed (ipm)	6.2	6.2	6.2	6.2	6.2	6.2	6.2	
M STAINLESS STEELS (FREE MACHINING) 303, 416, 420F, 430F, 440F		≤ 185 Bhn or ≤ 9 HRc	250 (200-300)	RPM	30560	7640	3820	2547	1910	1528	1091
				Fr	0.0006	0.0026	0.0051	0.0077	0.0102	0.0128	0.0179
				Feed (ipm)	19.5	19.5	19.5	19.5	19.5	19.5	19.5
	≤ 275 Bhn or ≤ 28 HRc	150 (120-180)	RPM	18336	4584	2292	1528	1146	917	655	
			Fr	0.0005	0.0020	0.0039	0.0059	0.0079	0.0098	0.0137	
			Feed (ipm)	9.0	9.0	9.0	9.0	9.0	9.0	9.0	
	≤ 275 Bhn or ≤ 28 HRc	80 (64-96)	RPM	9779	2445	1222	815	611	489	349	
			Fr	0.0005	0.0020	0.0039	0.0059	0.0079	0.0098	0.0137	
			Feed (ipm)	4.8	4.8	4.8	4.8	4.8	4.8	4.8	
	≤ 375 Bhn or ≤ 40 HRc	55 (44-66)	RPM	6723	1681	840	560	420	336	240	
			Fr	0.0004	0.0018	0.0036	0.0054	0.0071	0.0089	0.0125	
			Feed (ipm)	3.0	3.0	3.0	3.0	3.0	3.0	3.0	
K CAST IRONS Gray, Malleable, Ductile	≤ 220 Bhn or ≤ 19 HRc	300 (240-360)	RPM	36672	9168	4584	3056	2292	1834	1310	
			Fr	0.0011	0.0045	0.0089	0.0134	0.0179	0.0224	0.0313	
			Feed (ipm)	41.0	41.0	41.0	41.0	41.0	41.0	41.0	
	≤ 260 Bhn or ≤ 26 HRc	265 (212-318)	RPM	32394	8098	4049	2699	2025	1620	1157	
			Fr	0.0011	0.0046	0.0091	0.0137	0.0183	0.0228	0.0320	
			Feed (ipm)	37.0	37.0	37.0	37.0	37.0	37.0	37.0	

continued on next page

Series 135 5D Fractional	Hardness	Vc (sfm)	DC • in								
			1/32	1/8	1/4	3/8	1/2	5/8	7/8		
N ALUMINUM ALLOYS 2017, 2024, 356, 6061, 7075	≤ 80 Bhn or ≤ 47 HRb	635	RPM	77622	19406	9703	6469	4851	3881	2772	
		(508-762)	Fr	0.0012	0.0049	0.0099	0.0148	0.0198	0.0247	0.0346	
			Feed (ipm)	96.0	96.0	96.0	96.0	96.0	96.0	96.0	
	≤ 150 Bhn or ≤ 7 HRc	540	RPM	66010	16502	8251	5501	4126	3300	2357	
		(432-648)	Fr	0.0012	0.0050	0.0099	0.0149	0.0199	0.0248	0.0348	
			Feed (ipm)	82.0	82.0	82.0	82.0	82.0	82.0	82.0	
	COPPER ALLOYS Alum Bronze, C110, Muntz Brass	≤ 140 Bhn or ≤ 3 HRc	450	RPM	55008	13752	6876	4584	3438	2750	1965
			(360-540)	Fr	0.0005	0.0020	0.0040	0.0060	0.0080	0.0100	0.0140
				Feed (ipm)	27.5	27.5	27.5	27.5	27.5	27.5	27.5
		≤ 200 Bhn or ≤ 23 HRc	360	RPM	44006	11002	5501	3667	2750	2200	1572
			(288-432)	Fr	0.0005	0.0020	0.0040	0.0060	0.0080	0.0100	0.0140
				Feed (ipm)	22.0	22.0	22.0	22.0	22.0	22.0	22.0
S SUPER ALLOYS (Nickel , Cobalt, Iron Base) Inconel 601, 617, 625, Incoloy, Monel 400, Rene, Waspaloy	≤ 300 Bhn or ≤ 32 HRc	40	RPM	4890	1222	611	407	306	244	175	
		(32-48)	Fr	0.0002	0.0008	0.0016	0.0025	0.0033	0.0041	0.0057	
			Feed (ipm)	1.0	1.0	1.0	1.0	1.0	1.0	1.0	
	≤ 400 Bhn or ≤ 43 HRc	20	RPM	2445	611	306	204	153	122	87	
		(16-24)	Fr	0.0002	0.0007	0.0013	0.0020	0.0026	0.0033	0.0046	
			Feed (ipm)	0.4	0.4	0.4	0.4	0.4	0.4	0.4	
	TITANIUM ALLOYS Pure Titanium, Ti6Al4V, Ti6Al2Sn4Zr2Mo, Ti4Al4Mo2Sn0.5Si, Ti-6Al4V	≤ 275 Bhn or ≤ 28 HRc	105	RPM	12835	3209	1604	1070	802	642	458
			(84-126)	Fr	0.0005	0.0018	0.0036	0.0054	0.0072	0.0090	0.0127
				Feed (ipm)	5.8	5.8	5.8	5.8	5.8	5.8	5.8
		≤ 350 Bhn or ≤ 38 HRc	80	RPM	9779	2445	1222	815	611	489	349
			(64-96)	Fr	0.0004	0.0016	0.0032	0.0048	0.0064	0.0080	0.0112
				Feed (ipm)	3.9	3.9	3.9	3.9	3.9	3.9	3.9
≤ 440 Bhn or ≤ 47 HRc	42	RPM	5134	1284	642	428	321	257	183		
	(34-50)	Fr	0.0003	0.0012	0.0025	0.0037	0.0050	0.0062	0.0087		
		Feed (ipm)	1.6	1.6	1.6	1.6	1.6	1.6	1.6		
H TOOL STEELS A2, D2, H13, L2, M2, P20, S7, T15, W2	≤ 200 Bhn or ≤ 13 HRc	120	RPM	14669	3667	1834	1222	917	733	524	
		(96-144)	Fr	0.0006	0.0026	0.0051	0.0077	0.0103	0.0128	0.0179	
			Feed (ipm)	9.4	9.4	9.4	9.4	9.4	9.4	9.4	
	≤ 375 Bhn or ≤ 40 HRc	80	RPM	9779	2445	1222	815	611	489	349	
		(64-96)	Fr	0.0003	0.0012	0.0024	0.0036	0.0047	0.0059	0.0083	
			Feed (ipm)	2.9	2.9	2.9	2.9	2.9	2.9	2.9	
	≤ 475 Bhn or ≤ 50 HRc	70	RPM	8557	2139	1070	713	535	428	306	
		(56-84)	Fr	0.0002	0.0008	0.0016	0.0024	0.0032	0.0040	0.0056	
			Feed (ipm)	1.7	1.7	1.7	1.7	1.7	1.7	1.7	

Bhn (Brinell) HRc (Rockwell C) HRb (Rockwell B)
 rpm = Vc x 3.82 / DC
 ipm = Fr x rpm
 reduce speed and feed for materials harder than listed
 refer to the SGS Tool Wizard® for complete technical information (www.kyocera-sgstool.com)

Series 135M 5D Metric	Hardness	Vc (m/min)	DC • mm									
			1.5	3	6	8	10	12	16	20		
P CARBON STEELS 1018, 1040, 1080, 1090, 10L50, 1140, 1212, 12L15, 1525, 1536	≤ 175 Bhn or ≤ 7 HRc	105	RPM	22297	11148	5574	4181	3344	2787	2090	1672	
		(84-126)	Fr	0.048	0.095	0.190	0.254	0.317	0.380	0.507	0.634	
			Feed (mm/min)	1060	1060	1060	1060	1060	1060	1060	1060	
	≤ 275 Bhn or ≤ 28 HRc	94	RPM	20035	10017	5009	3756	3005	2504	1878	1503	
		(76-113)	Fr	0.043	0.085	0.171	0.228	0.285	0.341	0.455	0.569	
			Feed (mm/min)	855	855	855	855	855	855	855	855	
	≤ 425 Bhn or ≤ 45 HRc	55	RPM	11633	5816	2908	2181	1745	1454	1091	872	
		(44-66)	Fr	0.036	0.071	0.143	0.190	0.238	0.285	0.381	0.476	
			Feed (mm/min)	415	415	415	415	415	415	415	415	
	M ALLOY STEELS 4140, 4150, 4320, 5120, 5150, 8630, 86L20, 50100	≤ 275 Bhn or ≤ 28 HRc	82	RPM	17449	8725	4362	3272	2617	2181	1636	1309
			(66-99)	Fr	0.036	0.072	0.143	0.191	0.239	0.287	0.382	0.478
				Feed (mm/min)	625	625	625	625	625	625	625	625
≤ 375 Bhn or ≤ 40 HRc		50	RPM	10664	5332	2666	1999	1600	1333	1000	800	
		(40-60)	Fr	0.031	0.062	0.124	0.165	0.206	0.248	0.330	0.413	
			Feed (mm/min)	330	330	330	330	330	330	330	330	
≤ 450 Bhn or ≤ 48 HRc		35	RPM	7432	3716	1858	1394	1115	929	697	557	
		(28-42)	Fr	0.022	0.043	0.086	0.115	0.144	0.172	0.230	0.287	
			Feed (mm/min)	160	160	160	160	160	160	160	160	
K STAINLESS STEELS (FREE MACHINING) 303, 416, 420F, 430F, 440F		≤ 185 Bhn or ≤ 9 HRc	76	RPM	16157	8078	4039	3029	2424	2020	1515	1212
			(61-91)	Fr	0.031	0.061	0.123	0.163	0.204	0.245	0.327	0.408
				Feed (mm/min)	495	495	495	495	495	495	495	495
	≤ 275 Bhn or ≤ 28 HRc	46	RPM	9694	4847	2424	1818	1454	1212	909	727	
		(37-55)	Fr	0.024	0.047	0.095	0.127	0.158	0.190	0.253	0.316	
			Feed (mm/min)	230	230	230	230	230	230	230	230	
	K STAINLESS STEELS (DIFFICULT) 304, 316, 321, 13-8 PH, 15-5PH, 17-4 PH, Custom 450	≤ 275 Bhn or ≤ 28 HRc	24	RPM	5170	2585	1293	969	776	646	485	388
			(20-29)	Fr	0.023	0.046	0.093	0.124	0.155	0.186	0.248	0.309
				Feed (mm/min)	120	120	120	120	120	120	120	120
		≤ 375 Bhn or ≤ 40 HRc	17	RPM	3555	1777	889	666	533	444	333	267
			(13-20)	Fr	0.021	0.042	0.084	0.113	0.141	0.169	0.225	0.281
				Feed (mm/min)	75	75	75	75	75	75	75	75
K CAST IRONS Gray, Malleable, Ductile		≤ 220 Bhn or ≤ 19 HRc	91	RPM	19388	9694	4847	3635	2908	2424	1818	1454
			(73-110)	Fr	0.054	0.108	0.217	0.289	0.361	0.433	0.578	0.722
				Feed (mm/min)	1050	1050	1050	1050	1050	1050	1050	1050
		≤ 260 Bhn or ≤ 26 HRc	81	RPM	17126	8563	4282	3211	2569	2141	1606	1284
			(65-97)	Fr	0.055	0.109	0.218	0.291	0.364	0.437	0.582	0.728
				Feed (mm/min)	935	935	935	935	935	935	935	935

continued on next page

Series 135M 5D Metric	Hardness	Vc (m/min)	DC • mm									
			1.5	3	6	8	10	12	16	20		
N ALUMINUM ALLOYS 2017, 2024, 356, 6061, 7075	≤ 80 Bhn or ≤ 47 HRb	194	RPM	41039	20519	10260	7695	6156	5130	3847	3078	
		(155-232)	Fr	0.059	0.118	0.237	0.316	0.395	0.474	0.632	0.790	
			Feed (mm/min)	2430	2430	2430	2430	2430	2430	2430	2430	
	≤ 150 Bhn or ≤ 7 HRc	165	RPM	34899	17449	8725	6544	5235	4362	3272	2617	
		(132-198)	Fr	0.059	0.118	0.237	0.316	0.394	0.473	0.631	0.789	
			Feed (mm/min)	2065	2065	2065	2065	2065	2065	2065	2065	
	Copper Alloys Alum Bronze, C110, Muntz Brass	≤ 140 Bhn or ≤ 3 HRc	137	RPM	29082	14541	7271	5453	4362	3635	2726	2181
			(110-165)	Fr	0.027	0.053	0.107	0.142	0.178	0.213	0.284	0.355
				Feed (mm/min)	775	775	775	775	775	775	775	775
		≤ 200 Bhn or ≤ 23 HRc	110	RPM	23266	11633	5816	4362	3490	2908	2181	1745
			(88-132)	Fr	0.027	0.054	0.108	0.144	0.181	0.217	0.289	0.361
				Feed (mm/min)	630	630	630	630	630	630	630	630
S SUPER ALLOYS (Nickel , Cobalt, Iron Base) Inconel 601, 617, 625, Incoloy, Monel 400, Rene, Waspaloy	≤ 300 Bhn or ≤ 32 HRc	12	RPM	2585	1293	646	485	388	323	242	194	
		(10-15)	Fr	0.010	0.019	0.039	0.052	0.064	0.077	0.103	0.129	
			Feed (mm/min)	25	25	25	25	25	25	25	25	
	≤ 400 Bhn or ≤ 43 HRc	6	RPM	1293	646	323	242	194	162	121	97	
		(5-7)	Fr	0.007	0.014	0.028	0.037	0.046	0.056	0.074	0.093	
			Feed (mm/min)	9	9	9	9	9	9	9	9	
	TITANIUM ALLOYS Pure Titanium, Ti6Al4V, Ti6Al2Sn4Zr2Mo, Ti4Al4Mo2Sn0.5Si, Ti-6Al4V	≤ 275 Bhn or ≤ 28 HRc	32	RPM	6786	3393	1696	1272	1018	848	636	509
			(26-38)	Fr	0.021	0.043	0.085	0.114	0.142	0.171	0.228	0.285
				Feed (mm/min)	145	145	145	145	145	145	145	145
		≤ 350 Bhn or ≤ 38 HRc	24	RPM	5170	2585	1293	969	776	646	485	388
			(20-29)	Fr	0.019	0.039	0.077	0.103	0.129	0.155	0.206	0.258
				Feed (mm/min)	100	100	100	100	100	100	100	100
≤ 440 Bhn or ≤ 47 HRc	13	RPM	2714	1357	679	509	407	339	254	204		
	(10-15)	Fr	0.015	0.029	0.059	0.079	0.098	0.118	0.157	0.196		
		Feed (mm/min)	40	40	40	40	40	40	40	40		
H TOOL STEELS A2, D2, H13, L2, M2, P20, S7, T15, W2	≤ 200 Bhn or ≤ 13 HRc	37	RPM	7755	3878	1939	1454	1163	969	727	582	
		(29-44)	Fr	0.031	0.062	0.124	0.165	0.206	0.248	0.330	0.413	
			Feed (mm/min)	240	240	240	240	240	240	240	240	
	≤ 375 Bhn or ≤ 40 HRc	24	RPM	5170	2585	1293	969	776	646	485	388	
		(20-29)	Fr	0.015	0.029	0.058	0.077	0.097	0.116	0.155	0.193	
			Feed (mm/min)	75	75	75	75	75	75	75	75	
	≤ 475 Bhn or ≤ 50 HRc	21	RPM	4524	2262	1131	848	679	565	424	339	
		(17-26)	Fr	0.010	0.020	0.040	0.053	0.066	0.080	0.106	0.133	
			Feed (mm/min)	45	45	45	45	45	45	45	45	

Bhn (Brinell) HRc (Rockwell C) HRb (Rockwell B)
 $rpm = (Vc \times 1000) / (DC \times 3.14)$
 $mm/min = Fr \times rpm$
 reduce speed and feed for materials harder than listed
 refer to the SGS Tool Wizard® for complete technical information (www.kyocera-sgstool.com)



3xD

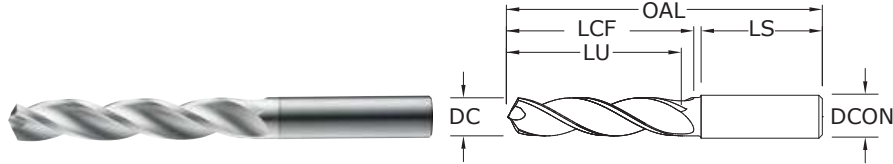

131N 3xD

FRACTIONAL & METRIC SERIES

- Triple margin design improves hole stability and size control while providing superior finish, roundness and cylindricity
- Self-stabilizing pyramid point design stabilizes the drill on contact with the workpiece
- Open flute structure efficiently transports chips while maintaining strength at high feed rates
- Sculpted gash allows chips to easily flow away from the drill center
- Recommended for materials ≤ 175 Bhn (≤ 16 HRC)

CUTTING DIAMETER DC	DECIMAL EQUIV.	METRIC EQUIV.	TAP SIZE REFERENCE ONLY	inch & mm					EDP NO.	
				SHANK DIAMETER DCON	OVERALL LENGTH OAL	FLUTE LENGTH LCF	CLEARED LENGTH LU	SHANK LENGTH LS	UNCOATED	Ti-NAMITE-B (TiB ₂)
3,0 mm	0.1181			6,0	62,0	20,0	14,0	36,0	64600	67600
3,1 mm	0.1220			6,0	62,0	20,0	14,0	36,0	64601	67601
1/8	0.1250	3.18		6,0	62,0	20,0	14,0	36,0	54600	54700
3,2 mm	0.1260		M3,5 X 0,35	6,0	62,0	20,0	14,0	36,0	64602	67602
3,3 mm	0.1299		M4 X 0,7	6,0	62,0	20,0	14,0	36,0	64603	67603
3,4 mm	0.1339			6,0	62,0	20,0	14,0	36,0	64604	67604
#29	0.1360	3.45	8-32,8-36	6,0	62,0	20,0	14,0	36,0	54601	54701
3,5 mm	0.1378		M4 X 0,5	6,0	62,0	20,0	14,0	36,0	64605	67605
9/64	0.1406	3.57		6,0	62,0	20,0	14,0	36,0	54602	54702
3,6 mm	0.1417		M4 X 0,35	6,0	62,0	20,0	14,0	36,0	64606	67606
3,7 mm	0.1457		M4,5 X 0,75	6,0	62,0	20,0	14,0	36,0	64607	67607
3,8 mm	0.1496		10-24	6,0	66,0	24,0	17,0	36,0	64608	67608
3,9 mm	0.1535			6,0	66,0	24,0	17,0	36,0	64609	67609
5/32	0.1562	3.97		6,0	66,0	24,0	17,0	36,0	54603	54703
4,0 mm	0.1575		M4,5 X 0,5	6,0	66,0	24,0	17,0	36,0	64610	67610
#21	0.1590	4.04	10-32	6,0	66,0	24,0	17,0	36,0	54604	54704
4,1 mm	0.1614			6,0	66,0	24,0	17,0	36,0	64611	67611
4,2 mm	0.1654		M5 / M5 X 0,75	6,0	66,0	24,0	17,0	36,0	64612	67612
4,3 mm	0.1693			6,0	66,0	24,0	17,0	36,0	64613	67613
11/64	0.1719	4.37		6,0	66,0	24,0	17,0	36,0	54605	54705
4,4 mm	0.1732		12-24	6,0	66,0	24,0	17,0	36,0	64614	67614
4,5 mm	0.1772		M5 X 0,5	6,0	66,0	24,0	17,0	36,0	64615	67615
4,6 mm	0.1811		12-28	6,0	66,0	24,0	17,0	36,0	64616	67616
4,7 mm	0.1850		12-32	6,0	66,0	24,0	17,0	36,0	64617	67617
3/16	0.1875	4.76		6,0	66,0	28,0	20,0	36,0	54606	54706
4,8 mm	0.1890		7/32-32	6,0	66,0	28,0	20,0	36,0	64618	67618
4,9 mm	0.1929			6,0	66,0	28,0	20,0	36,0	64619	67619
5,0 mm	0.1969		M6 X 1	6,0	66,0	28,0	20,0	36,0	64620	67620
5,1 mm	0.2008		1/4-20	6,0	66,0	28,0	20,0	36,0	64621	67621
13/64	0.2031	5.16		6,0	66,0	28,0	20,0	36,0	54607	54707
5,2 mm	0.2047		M6 X 0,75	6,0	66,0	28,0	20,0	36,0	64622	67622
5,3 mm	0.2087			6,0	66,0	28,0	20,0	36,0	64623	67623
5,4 mm	0.2126			6,0	66,0	28,0	20,0	36,0	64624	67624
5,5 mm	0.2165		M6 X 0,5	6,0	66,0	28,0	20,0	36,0	64625	67625
7/32	0.2188	5.56	1/4-32	6,0	66,0	28,0	20,0	36,0	54608	54708
5,6 mm	0.2205			6,0	66,0	28,0	20,0	36,0	64626	67626

TOLERANCES (inch)

- ≤.1181 DIAMETER**
DC = +.00008/+0.00047
DCON = h₆
- >.1181–.2362 DIAMETER**
DC = +.00016/+0.00063
DCON = h₆
- >.2362–.3937 DIAMETER**
DC = +.00028/+0.00083
DCON = h₆
- >.3937–.7087 DIAMETER**
DC = +.00031/+0.00098
DCON = h₆
- >.7087–1.1811 DIAMETER**
DC = +.00031/+0.00114
DCON = h₆

TOLERANCES (mm)

- ≤3 DIAMETER**
DC = +0,002/+0,012
DCON = h₆
- >3–6 DIAMETER**
DC = +0,004/+0,016
DCON = h₆
- >6–10 DIAMETER**
DC = +0,006/+0,021
DCON = h₆
- >10–18 DIAMETER**
DC = +0,007/+0,025
DCON = h₆

NON-FERROUS

PLASTICS/COMPOSITES

For patent information visit www.ksptpatents.com

continued on next page



131N 3xD
FRACTIONAL & METRIC SERIES

inch & mm									EDP NO.		CONTINUED
CUTTING DIAMETER DC	DECIMAL EQUIV.	METRIC EQUIV.	TAP SIZE REFERENCE ONLY	SHANK DIAMETER DCON	OVERALL LENGTH OAL	FLUTE LENGTH LCF	CLEARED LENGTH LU	SHANK LENGTH LS	UNCOATED	Ti-NAMITE-B (TiB ₂)	
5,7 mm	0.2244			6,0	66,0	28,0	20,0	36,0	64627	67627	
5,8 mm	0.2283			6,0	66,0	28,0	20,0	36,0	64628	67628	
5,9 mm	0.2323			6,0	66,0	28,0	20,0	36,0	64629	67629	
15/64	0.2344	5.95		6,0	66,0	28,0	20,0	36,0	54609	54709	
6,0 mm	0.2362		M7 X 1	6,0	66,0	28,0	20,0	36,0	64630	67630	
6,1 mm	0.2402			8,0	79,0	34,0	24,0	36,0	64631	67631	
6,2 mm	0.2441		M7 X 0,75	8,0	79,0	34,0	24,0	36,0	64632	67632	
6,3 mm	0.2480			8,0	79,0	34,0	24,0	36,0	64633	67633	
1/4	0.2500	6.35		8,0	79,0	34,0	24,0	36,0	54610	54710	
6,4 mm	0.2520			8,0	79,0	34,0	24,0	36,0	64634	67634	
6,5 mm	0.2559			8,0	79,0	34,0	24,0	36,0	64635	67635	
F	0.2570	6.53	5/16-18	8,0	79,0	34,0	24,0	36,0	54611	54711	
6,6 mm	0.2598			8,0	79,0	34,0	24,0	36,0	64636	67636	
6,7 mm	0.2638			8,0	79,0	34,0	24,0	36,0	64637	67637	
17/64	0.2656	6.75	5/16-20	8,0	79,0	34,0	24,0	36,0	54612	54712	
6,8 mm	0.2677		M8 X 1,25	8,0	79,0	34,0	24,0	36,0	64638	67638	
6,9 mm	0.2717		5/16-24	8,0	79,0	34,0	24,0	36,0	64639	67639	
7,0 mm	0.2756		M8 X 1	8,0	79,0	34,0	24,0	36,0	64640	67640	
7,1 mm	0.2795			8,0	79,0	41,0	29,0	36,0	64641	67641	
9/32	0.2812	7.14	5/16-32	8,0	79,0	41,0	29,0	36,0	54613	54713	
7,2 mm	0.2835		M8 X 0,75	8,0	79,0	41,0	29,0	36,0	64642	67642	
7,3 mm	0.2874			8,0	79,0	41,0	29,0	36,0	64643	67643	
7,4 mm	0.2913			8,0	79,0	41,0	29,0	36,0	64644	67644	
7,5 mm	0.2953		M8 X 0,5	8,0	79,0	41,0	29,0	36,0	64645	67645	
19/64	0.2969	7.54		8,0	79,0	41,0	29,0	36,0	54614	54714	
7,6 mm	0.2992			8,0	79,0	41,0	29,0	36,0	64646	67646	
7,7 mm	0.3031			8,0	79,0	41,0	29,0	36,0	64647	67647	
7,8 mm	0.3071		M9 X 1,25	8,0	79,0	41,0	29,0	36,0	64648	67648	
7,9 mm	0.3110			8,0	79,0	41,0	29,0	36,0	64649	67649	
5/16	0.3125	7.94	3/8-16	8,0	79,0	41,0	29,0	36,0	54615	54715	
8,0 mm	0.3150		M9 X 1	8,0	79,0	41,0	29,0	36,0	64650	67650	
8,1 mm	0.3189			10,0	89,0	47,0	35,0	40,0	64651	67651	
8,2 mm	0.3228			10,0	89,0	47,0	35,0	40,0	64652	67652	
8,3 mm	0.3268			10,0	89,0	47,0	35,0	40,0	64653	67653	
21/64	0.3281	8.33	3/8-20	10,0	89,0	47,0	35,0	40,0	54616	54716	
8,4 mm	0.3307			10,0	89,0	47,0	35,0	40,0	64654	67654	
Q	0.3320	8.43	3/8-24	10,0	89,0	47,0	35,0	40,0	54617	54717	
8,5 mm	0.3346		M10 X 1,5	10,0	89,0	47,0	35,0	40,0	64655	67655	
8,6 mm	0.3386			10,0	89,0	47,0	35,0	40,0	64656	67656	
8,7 mm	0.3425			10,0	89,0	47,0	35,0	40,0	64657	67657	
11/32	0.3438	8.73	3/8-32	10,0	89,0	47,0	35,0	40,0	54618	54718	
8,8 mm	0.3465		M10 X 1,25	10,0	89,0	47,0	35,0	40,0	64658	67658	
8,9 mm	0.3504			10,0	89,0	47,0	35,0	40,0	64659	67659	
9,0 mm	0.3543		M10 X 1	10,0	89,0	47,0	35,0	40,0	64660	67660	
9,1 mm	0.3583			10,0	89,0	47,0	35,0	40,0	64661	67661	
23/64	0.3594	9.13		10,0	89,0	47,0	35,0	40,0	54619	54719	

continued on next page

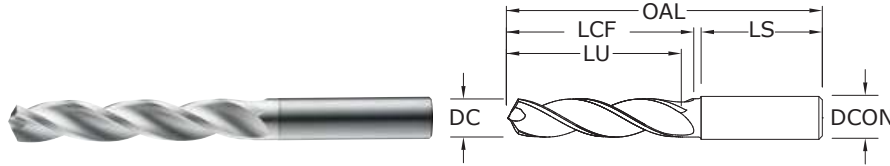

131N 3xD

FRACTIONAL & METRIC SERIES

- Triple margin design improves hole stability and size control while providing superior finish, roundness and cylindricity
- Self-stabilizing pyramid point design stabilizes the drill on contact with the workpiece
- Open flute structure efficiently transports chips while maintaining strength at high feed rates
- Sculpted gash allows chips to easily flow away from the drill center
- Recommended for materials ≤ 175 Bhn (≤ 16 HRC)

CUTTING DIAMETER DC	DECIMAL EQUIV.	METRIC EQUIV.	TAP SIZE REFERENCE ONLY	inch & mm					EDP NO.	
				SHANK DIAMETER DCON	OVERALL LENGTH OAL	FLUTE LENGTH LCF	CLEARED LENGTH LU	SHANK LENGTH LS	UNCOATED	Ti-NAMITE-B (TiB ₂)
9,2 mm	0.3622		M10 X 0,75	10,0	89,0	47,0	35,0	40,0	64662	67662
9,3 mm	0.3661			10,0	89,0	47,0	35,0	40,0	64663	67663
U	0.3680	9.35	7/16-14	10,0	89,0	47,0	35,0	40,0	54620	54720
9,4 mm	0.3701			10,0	89,0	47,0	35,0	40,0	64664	67664
9,5 mm	0.3740		M11 / M10 X 0,5	10,0	89,0	47,0	35,0	40,0	64665	67665
3/8	0.3750	9.53		10,0	89,0	47,0	35,0	40,0	54621	54721
9,6 mm	0.3780			10,0	89,0	47,0	35,0	40,0	64666	67666
9,7 mm	0.3819			10,0	89,0	47,0	35,0	40,0	64667	67667
9,8 mm	0.3858			10,0	89,0	47,0	35,0	40,0	64668	67668
9,9 mm	0.3898			10,0	89,0	47,0	35,0	40,0	64669	67669
25/64	0.3906	9.92	7/16-20	10,0	89,0	47,0	35,0	40,0	54622	54722
10,0 mm	0.3937			10,0	89,0	47,0	35,0	40,0	64670	67670
10,1 mm	0.3976			12,0	102,0	55,0	40,0	45,0	64671	67671
10,2 mm	0.4016		M12 X 1,75	12,0	102,0	55,0	40,0	45,0	64672	67672
10,3 mm	0.4055			12,0	102,0	55,0	40,0	45,0	64673	67673
13/32	0.4062	10.32		12,0	102,0	55,0	40,0	45,0	54623	54723
10,4 mm	0.4094			12,0	102,0	55,0	40,0	45,0	64674	67674
10,5 mm	0.4134		M12 X 1,5	12,0	102,0	55,0	40,0	45,0	64675	67675
10,6 mm	0.4173			12,0	102,0	55,0	40,0	45,0	64676	67676
10,7 mm	0.4213			12,0	102,0	55,0	40,0	45,0	64677	67677
27/64	0.4219	10.72	1/2-13	12,0	102,0	55,0	40,0	45,0	54624	54724
10,8 mm	0.4252		M12 X 1,25	12,0	102,0	55,0	40,0	45,0	64678	67678
10,9 mm	0.4291			12,0	102,0	55,0	40,0	45,0	64679	67679
11,0 mm	0.4331		M12 X 1	12,0	102,0	55,0	40,0	45,0	64680	67680
11,1 mm	0.4370			12,0	102,0	55,0	40,0	45,0	64681	67681
7/16	0.4375	11.11	1/4-18NPT	12,0	102,0	55,0	40,0	45,0	54625	54725
11,2 mm	0.4409			12,0	102,0	55,0	40,0	45,0	64682	67682
11,3 mm	0.4449			12,0	102,0	55,0	40,0	45,0	64683	67683
11,4 mm	0.4488			12,0	102,0	55,0	40,0	45,0	64684	67684
11,5 mm	0.4528		M12 X 0,5	12,0	102,0	55,0	40,0	45,0	64685	67685
11,6 mm	0.4567			12,0	102,0	55,0	40,0	45,0	64686	67686
11,7 mm	0.4606			12,0	102,0	55,0	40,0	45,0	64687	67687
11,8 mm	0.4646			12,0	102,0	55,0	40,0	45,0	64688	67688
11,9 mm	0.4685			12,0	102,0	55,0	40,0	45,0	64689	67689
15/32	0.4688	11.91	1/2-28	12,0	102,0	55,0	40,0	45,0	54626	54726
12,0 mm	0.4724		M14 X 2	12,0	102,0	55,0	40,0	45,0	64690	67690

TOLERANCES (inch)

- $\leq .1181$ DIAMETER
DC = +.00008/+0.00047
DCON = h_6
- $>.1181-.2362$ DIAMETER
DC = +.00016/+0.00063
DCON = h_6
- $>.2362-.3937$ DIAMETER
DC = +.00028/+0.00093
DCON = h_6
- $>.3937-.7087$ DIAMETER
DC = +.00031/+0.00098
DCON = h_6
- $>.7087-1.1811$ DIAMETER
DC = +.00031/+0.00114
DCON = h_6

TOLERANCES (mm)

- ≤ 3 DIAMETER
DC = +0,002/+0,012
DCON = h_6
- $>3-6$ DIAMETER
DC = +0,004/+0,016
DCON = h_6
- $>6-10$ DIAMETER
DC = +0,006/+0,021
DCON = h_6
- $>10-18$ DIAMETER
DC = +0,007/+0,025
DCON = h_6



For patent information visit www.ksptpatents.com

continued on next page



131N 3xD
FRACTIONAL & METRIC SERIES

inch & mm									EDP NO.		CONTINUED
CUTTING DIAMETER DC	DECIMAL EQUIV.	METRIC EQUIV.	TAP SIZE REFERENCE ONLY	SHANK DIAMETER DCON	OVERALL LENGTH OAL	FLUTE LENGTH LCF	CLEARED LENGTH LU	SHANK LENGTH LS	UNCOATED	Ti-NAMITE-B (TiB ₂)	
31/64	0.4844	12.30	9/16-12	14,0	107,0	60,0	43,0	45,0	54627	54727	
12,5 mm	0.4921		M14 X 1,5	14,0	107,0	60,0	43,0	45,0	64691	67691	
1/2	0.5000	12.70		14,0	107,0	60,0	43,0	45,0	54628	54728	
12,8 mm	0.5039		M14 X 1,25	14,0	107,0	60,0	43,0	45,0	64692	67692	
13,0 mm	0.5118		M14 X 1	14,0	107,0	60,0	43,0	45,0	64693	67693	
33/64	0.5156	13.10	9/16-18	14,0	107,0	60,0	43,0	45,0	54629	54729	
13,5 mm	0.5315		5/8-11	14,0	107,0	60,0	43,0	45,0	64694	67694	
13,8 mm	0.5433			14,0	107,0	60,0	43,0	45,0	64695	67695	
14,0 mm	0.5512		M16 X 2	14,0	107,0	60,0	43,0	45,0	64696	67696	
9/16	0.5625	14.29		16,0	115,0	65,0	45,0	48,0	54630	54730	
14,5 mm	0.5709		M16 X 1,5	16,0	115,0	65,0	45,0	48,0	64697	67697	
37/64	0.5781	14.68	5/8-18	16,0	115,0	65,0	45,0	48,0	54631	54731	
14,8 mm	0.5827			16,0	115,0	65,0	45,0	48,0	64698	67698	
15,0 mm	0.5906		M16 X 1	16,0	115,0	65,0	45,0	48,0	64699	67699	
15,5 mm	0.6102		M18 X 2,5	16,0	115,0	65,0	45,0	48,0	64700	67700	
15,8 mm	0.6220			16,0	115,0	65,0	45,0	48,0	64701	67701	
5/8	0.6250	15.88	11/16-16	16,0	115,0	65,0	45,0	48,0	54632	54732	
16,0 mm	0.6299			16,0	115,0	65,0	45,0	48,0	64702	67702	
21/32	0.6562	16.67	3/4-10	18,0	123,0	73,0	51,0	48,0	54633	54733	
11/16	0.6875	17.46	3/4-16	18,0	123,0	73,0	51,0	48,0	54634	54734	
3/4	0.7500	19.05	13/16-16	20,0	131,0	79,0	55,0	50,0	54635	54735	



5xD

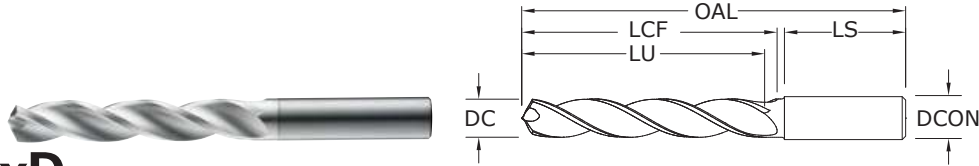

131N 5xD

FRACTIONAL & METRIC SERIES

- Triple margin design improves hole stability and size control while providing superior finish, roundness and cylindricity
- Self-stabilizing pyramid point design stabilizes the drill on contact with the workpiece
- Open flute structure efficiently transports chips while maintaining strength at high feed rates
- Sculpted gash allows chips to easily flow away from the drill center
- Recommended for materials ≤ 175 Bhn (≤ 16 HRc)

CUTTING DIAMETER DC	DECIMAL EQUIV.	METRIC EQUIV.	TAP SIZE REFERENCE ONLY	inch & mm					EDP NO.	
				SHANK DIAMETER DCON	OVERALL LENGTH OAL	FLUTE LENGTH LCF	CLEARED LENGTH LU	SHANK LENGTH LS	UNCOATED	Ti-NAMITE-B (TiB ₂)
3,0 mm	0.1181			6,0	66,0	28,0	23,0	36,0	65000	64800
3,1 mm	0.1220			6,0	66,0	28,0	23,0	36,0	65001	64801
1/8	0.1250	3.18		6,0	66,0	28,0	23,0	36,0	55000	54800
3,2 mm	0.1260		M3,5 X 0,35	6,0	66,0	28,0	23,0	36,0	65002	64802
3,3 mm	0.1299		M4 X 0,7	6,0	66,0	28,0	23,0	36,0	65003	64803
3,4 mm	0.1339			6,0	66,0	28,0	23,0	36,0	65004	64804
#29	0.1360	3.45	8-32,8-36	6,0	66,0	28,0	23,0	36,0	55001	54801
3,5 mm	0.1378		M4 X 0,5	6,0	66,0	28,0	23,0	36,0	65005	64805
9/64	0.1406	3.57		6,0	66,0	28,0	23,0	36,0	55002	54802
3,6 mm	0.1417		M4 X 0,35	6,0	66,0	28,0	23,0	36,0	65006	64806
3,7 mm	0.1457		M4,5 X 0,75	6,0	66,0	28,0	23,0	36,0	65007	64807
3,8 mm	0.1496		10-24	6,0	74,0	36,0	29,0	36,0	65008	64808
3,9 mm	0.1535			6,0	74,0	36,0	29,0	36,0	65009	64809
5/32	0.1562	3.97		6,0	74,0	36,0	29,0	36,0	55003	54803
4,0 mm	0.1575		M4,5 X 0,5	6,0	74,0	36,0	29,0	36,0	65010	64810
#21	0.1590	4.04	10-32	6,0	74,0	36,0	29,0	36,0	55004	54804
4,1 mm	0.1614			6,0	74,0	36,0	29,0	36,0	65011	64811
4,2 mm	0.1654		M5 / M5 X 0,75	6,0	74,0	36,0	29,0	36,0	65012	64812
4,3 mm	0.1693			6,0	74,0	36,0	29,0	36,0	65013	64813
11/64	0.1719	4.37		6,0	74,0	36,0	29,0	36,0	55005	54805
4,4 mm	0.1732		12-24	6,0	74,0	36,0	29,0	36,0	65014	64814
4,5 mm	0.1772		M5 X 0,5	6,0	74,0	36,0	29,0	36,0	65015	64815
4,6 mm	0.1811		12-28	6,0	74,0	36,0	29,0	36,0	65016	64816
4,7 mm	0.1850		12-32	6,0	74,0	36,0	29,0	36,0	65017	64817
3/16	0.1875	4.76		6,0	82,0	44,0	35,0	36,0	55006	54806
4,8 mm	0.1890		7/32-32	6,0	82,0	44,0	35,0	36,0	65018	64818
4,9 mm	0.1929			6,0	82,0	44,0	35,0	36,0	65019	64819
5,0 mm	0.1969		M6 X 1	6,0	82,0	44,0	35,0	36,0	65020	64820
5,1 mm	0.2008		1/4-20	6,0	82,0	44,0	35,0	36,0	65021	64821
13/64	0.2031	5.16		6,0	82,0	44,0	35,0	36,0	55007	54807
5,2 mm	0.2047		M6 X 0,75	6,0	82,0	44,0	35,0	36,0	65022	64822
5,3 mm	0.2087			6,0	82,0	44,0	35,0	36,0	65023	64823
5,4 mm	0.2126			6,0	82,0	44,0	35,0	36,0	65024	64824
5,5 mm	0.2165		M6 X 0,5	6,0	82,0	44,0	35,0	36,0	65025	64825
7/32	0.2188	5.56	1/4-32	6,0	82,0	44,0	35,0	36,0	55008	54808

continued on next page

TOLERANCES (inch)

- ≤.1181 DIAMETER**
DC = +.00008/+0.00047
DCON = h₆
- >.1181–.2362 DIAMETER**
DC = +.00016/+0.00063
DCON = h₆
- >.2362–.3937 DIAMETER**
DC = +.00028/+0.00083
DCON = h₆
- >.3937–.7087 DIAMETER**
DC = +.00031/+0.00098
DCON = h₆
- >.7087–1.1811 DIAMETER**
DC = +.00031/+0.00114
DCON = h₆

TOLERANCES (mm)

- ≤3 DIAMETER**
DC = +0,002/+0,012
DCON = h₆
- >3–6 DIAMETER**
DC = +0,004/+0,016
DCON = h₆
- >6–10 DIAMETER**
DC = +0,006/+0,021
DCON = h₆
- >10–18 DIAMETER**
DC = +0,007/+0,025
DCON = h₆

- NON-FERROUS
- PLASTICS/COMPOSITES

For patent information visit www.ksptpatents.com

131N 5xD
FRACTIONAL & METRIC SERIES

inch & mm									EDP NO.		CONTINUED
CUTTING DIAMETER DC	DECIMAL EQUIV.	METRIC EQUIV.	TAP SIZE REFERENCE ONLY	SHANK DIAMETER DCON	OVERALL LENGTH OAL	FLUTE LENGTH LCF	CLEARED LENGTH LU	SHANK LENGTH LS	UNCOATED	TI-NAMITE-B (TiB ₂)	
5,6 mm	0.2205			6,0	82,0	44,0	35,0	36,0	65026	64826	
5,7 mm	0.2244			6,0	82,0	44,0	35,0	36,0	65027	64827	
5,8 mm	0.2283			6,0	82,0	44,0	35,0	36,0	65028	64828	
5,9 mm	0.2323			6,0	82,0	44,0	35,0	36,0	65029	64829	
15/64	0.2344	5.95		6,0	82,0	44,0	35,0	36,0	55009	54809	
6,0 mm	0.2362		M7 X 1	6,0	82,0	44,0	35,0	36,0	65030	64830	
6,1 mm	0.2402			8,0	91,0	53,0	43,0	36,0	65031	64831	
6,2 mm	0.2441		M7 X 0,75	8,0	91,0	53,0	43,0	36,0	65032	64832	
6,3 mm	0.2480			8,0	91,0	53,0	43,0	36,0	65033	64833	
1/4	0.2500	6.35		8,0	91,0	53,0	43,0	36,0	55010	54810	
6,4 mm	0.2520			8,0	91,0	53,0	43,0	36,0	65034	64834	
6,5 mm	0.2559			8,0	91,0	53,0	43,0	36,0	65035	64835	
F	0.2570	6.53	5/16-18	8,0	91,0	53,0	43,0	36,0	55011	54811	
6,6 mm	0.2598			8,0	91,0	53,0	43,0	36,0	65036	64836	
6,7 mm	0.2638			8,0	91,0	53,0	43,0	36,0	65037	64837	
17/64	0.2656	6.75	5/16-20	8,0	91,0	53,0	43,0	36,0	55012	54812	
6,8 mm	0.2677		M8 X 1,25	8,0	91,0	53,0	43,0	36,0	65038	64838	
6,9 mm	0.2717		5/16-24	8,0	91,0	53,0	43,0	36,0	65039	64839	
7,0 mm	0.2756		M8 X 1	8,0	91,0	53,0	43,0	36,0	65040	64840	
7,1 mm	0.2795			8,0	91,0	53,0	43,0	36,0	65041	64841	
9/32	0.2812	7.14	5/16-32	8,0	91,0	53,0	43,0	36,0	55013	54813	
7,2 mm	0.2835		M8 X 0,75	8,0	91,0	53,0	43,0	36,0	65042	64842	
7,3 mm	0.2874			8,0	91,0	53,0	43,0	36,0	65043	64843	
7,4 mm	0.2913			8,0	91,0	53,0	43,0	36,0	65044	64844	
7,5 mm	0.2953		M8 X 0,5	8,0	91,0	53,0	43,0	36,0	65045	64845	
19/64	0.2969	7.54		8,0	91,0	53,0	43,0	36,0	55014	54814	
7,6 mm	0.2992			8,0	91,0	53,0	43,0	36,0	65046	64846	
7,7 mm	0.3031			8,0	91,0	53,0	43,0	36,0	65047	64847	
7,8 mm	0.3071		M9 X 1,25	8,0	91,0	53,0	43,0	36,0	65048	64848	
7,9 mm	0.3110			8,0	91,0	53,0	43,0	36,0	65049	64849	
5/16	0.3125	7.94	3/8-16	8,0	91,0	53,0	43,0	36,0	55015	54815	
8,0 mm	0.3150		M9 X 1	8,0	91,0	53,0	43,0	36,0	65050	64850	
8,1 mm	0.3189			10,0	103,0	61,0	49,0	40,0	65051	64851	
8,2 mm	0.3228			10,0	103,0	61,0	49,0	40,0	65052	64852	
8,3 mm	0.3268			10,0	103,0	61,0	49,0	40,0	65053	64853	
21/64	0.3281	8.33	3/8-20	10,0	103,0	61,0	49,0	40,0	55016	54816	
8,4 mm	0.3307			10,0	103,0	61,0	49,0	40,0	65054	64854	
Q	0.3320	8.43	3/8-24	10,0	103,0	61,0	49,0	40,0	55017	54817	
8,5 mm	0.3346		M10 X 1,5	10,0	103,0	61,0	49,0	40,0	65055	64855	
8,6 mm	0.3386			10,0	103,0	61,0	49,0	40,0	65056	64856	
8,7 mm	0.3425			10,0	103,0	61,0	49,0	40,0	65057	64857	
11/32	0.3438	8.73	3/8-32	10,0	103,0	61,0	49,0	40,0	55018	54818	
8,8 mm	0.3465		M10 X 1,25	10,0	103,0	61,0	49,0	40,0	65058	64858	
8,9 mm	0.3504			10,0	103,0	61,0	49,0	40,0	65059	64859	
9,0 mm	0.3543		M10 X 1	10,0	103,0	61,0	49,0	40,0	65060	64860	
9,1 mm	0.3583			10,0	103,0	61,0	49,0	40,0	65061	64861	

continued on next page



5xD

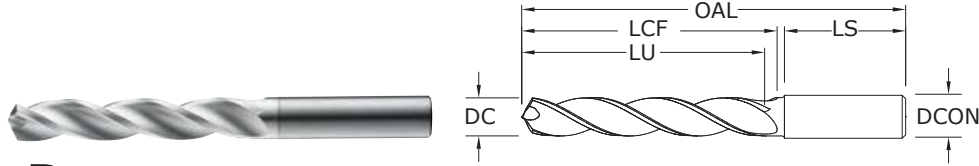

131N 5xD

FRACTIONAL & METRIC SERIES

- Triple margin design improves hole stability and size control while providing superior finish, roundness and cylindricity
- Self-stabilizing pyramid point design stabilizes the drill on contact with the workpiece
- Open flute structure efficiently transports chips while maintaining strength at high feed rates
- Sculpted gash allows chips to easily flow away from the drill center
- Recommended for materials ≤ 175 Bhn (≤ 16 HRC)

CUTTING DIAMETER DC	DECIMAL EQUIV.	METRIC EQUIV.	TAP SIZE REFERENCE ONLY	inch & mm					EDP NO.	
				SHANK DIAMETER DCON	OVERALL LENGTH OAL	FLUTE LENGTH LCF	CLEARED LENGTH LU	SHANK LENGTH LS	UNCOATED	Ti-NAMITE-B (TiB ₂)
23/64	0.3594	9.13		10,0	103,0	61,0	49,0	40,0	55019	54819
9,2 mm	0.3622		M10 X 0,75	10,0	103,0	61,0	49,0	40,0	65062	64862
9,3 mm	0.3661			10,0	103,0	61,0	49,0	40,0	65063	64863
U	0.3680	9.35	7/16-14	10,0	103,0	61,0	49,0	40,0	55020	54820
9,4 mm	0.3701			10,0	103,0	61,0	49,0	40,0	65064	64864
9,5 mm	0.3740		M11 / M10 X 0,5	10,0	103,0	61,0	49,0	40,0	65065	64865
3/8	0.3750	9.53		10,0	103,0	61,0	49,0	40,0	55021	54821
9,6 mm	0.3780			10,0	103,0	61,0	49,0	40,0	65066	64866
9,7 mm	0.3819			10,0	103,0	61,0	49,0	40,0	65067	64867
9,8 mm	0.3858			10,0	103,0	61,0	49,0	40,0	65068	64868
9,9 mm	0.3898			10,0	103,0	61,0	49,0	40,0	65069	64869
25/64	0.3906	9.92	7/16-20	10,0	103,0	61,0	49,0	40,0	55022	54822
10,0 mm	0.3937			10,0	103,0	61,0	49,0	40,0	65070	64870
10,1 mm	0.3976			12,0	118,0	71,0	56,0	45,0	65071	64871
10,2 mm	0.4016		M12 X 1,75	12,0	118,0	71,0	56,0	45,0	65072	64872
10,3 mm	0.4055			12,0	118,0	71,0	56,0	45,0	65073	64873
13/32	0.4062	10.32		12,0	118,0	71,0	56,0	45,0	55023	54823
10,4 mm	0.4094			12,0	118,0	71,0	56,0	45,0	65074	64874
10,5 mm	0.4134		M12 X 1,5	12,0	118,0	71,0	56,0	45,0	65075	64875
10,6 mm	0.4173			12,0	118,0	71,0	56,0	45,0	65076	64876
10,7 mm	0.4213			12,0	118,0	71,0	56,0	45,0	65077	64877
27/64	0.4219	10.72	1/2-13	12,0	118,0	71,0	56,0	45,0	55024	54824
10,8 mm	0.4252		M12 X 1,25	12,0	118,0	71,0	56,0	45,0	65078	64878
10,9 mm	0.4291			12,0	118,0	71,0	56,0	45,0	65079	64879
11,0 mm	0.4331		M12 X 1	12,0	118,0	71,0	56,0	45,0	65080	64880
11,1 mm	0.4370			12,0	118,0	71,0	56,0	45,0	65081	64881
7/16	0.4375	11.11	1/4-18NPT	12,0	118,0	71,0	56,0	45,0	55025	54825
11,2 mm	0.4409			12,0	118,0	71,0	56,0	45,0	65082	64882
11,3 mm	0.4449			12,0	118,0	71,0	56,0	45,0	65083	64883
11,4 mm	0.4488			12,0	118,0	71,0	56,0	45,0	65084	64884
11,5 mm	0.4528		M12 X 0,5	12,0	118,0	71,0	56,0	45,0	65085	64885
11,6 mm	0.4567			12,0	118,0	71,0	56,0	45,0	65086	64886
11,7 mm	0.4606			12,0	118,0	71,0	56,0	45,0	65087	64887
11,8 mm	0.4646			12,0	118,0	71,0	56,0	45,0	65088	64888

continued on next page

TOLERANCES (inch)

- ≤.1181 DIAMETER
DC = +.00008/+0.00047
DCON = h₆
- >.1181-.2362 DIAMETER
DC = +.00016/+0.00063
DCON = h₆
- >.2362-.3937 DIAMETER
DC = +.00028/+0.00083
DCON = h₆
- >.3937-.7087 DIAMETER
DC = +.00031/+0.00098
DCON = h₆
- >.7087-1.1811 DIAMETER
DC = +.00031/+0.00114
DCON = h₆

TOLERANCES (mm)

- ≤3 DIAMETER
DC = +0,002/+0,012
DCON = h₆
- >3-6 DIAMETER
DC = +0,004/+0,016
DCON = h₆
- >6-10 DIAMETER
DC = +0,006/+0,021
DCON = h₆
- >10-18 DIAMETER
DC = +0,007/+0,025
DCON = h₆

- NON-FERROUS
- PLASTICS/COMPOSITES

For patent information visit www.ksptpatents.com



131N 5xD
FRACTIONAL & METRIC SERIES

inch & mm									EDP NO.		CONTINUED
CUTTING DIAMETER DC	DECIMAL EQUIV.	METRIC EQUIV.	TAP SIZE REFERENCE ONLY	SHANK DIAMETER DCON	OVERALL LENGTH OAL	FLUTE LENGTH LCF	CLEARED LENGTH LU	SHANK LENGTH LS	UNCOATED	Ti-NAMITE-B (TiB ₂)	
11,9 mm	0.4685			12,0	118,0	71,0	56,0	45,0	65089	64889	
15/32	0.4688	11.91	1/2-28	12,0	118,0	71,0	56,0	45,0	55026	54826	
12,0 mm	0.4724		M14 X 2	12,0	118,0	71,0	56,0	45,0	65090	64890	
31/64	0.4844	12.30	9/16-12	14,0	124,0	77,0	60,0	45,0	55027	54827	
12,5 mm	0.4921		M14 X 1,5	14,0	124,0	77,0	60,0	45,0	65091	64891	
1/2	0.5000	12.70		14,0	124,0	77,0	60,0	45,0	55028	54828	
12,8 mm	0.5039		M14 X 1,25	14,0	124,0	77,0	60,0	45,0	65092	64892	
13,0 mm	0.5118		M14 X 1	14,0	124,0	77,0	60,0	45,0	65093	64893	
33/64	0.5156	13.10	9/16-18	14,0	124,0	77,0	60,0	45,0	55029	54829	
13,5 mm	0.5315		5/8-11	14,0	124,0	77,0	60,0	45,0	65094	64894	
13,8 mm	0.5433			14,0	124,0	77,0	60,0	45,0	65095	64895	
14,0 mm	0.5512		M16 X 2	14,0	124,0	77,0	60,0	45,0	65096	64896	
9/16	0.5625	14.29		16,0	133,0	83,0	63,0	48,0	55030	54830	
14,5 mm	0.5709		M16 X 1,5	16,0	133,0	83,0	63,0	48,0	65097	64897	
37/64	0.5781	14.68	5/8-18	16,0	133,0	83,0	63,0	48,0	55031	54831	
14,8 mm	0.5827			16,0	133,0	83,0	63,0	48,0	65098	64898	
15,0 mm	0.5906		M16 X 1	16,0	133,0	83,0	63,0	48,0	65099	64899	
15,5 mm	0.6102		M18 X 2,5	16,0	133,0	83,0	63,0	48,0	65100	64900	
15,8 mm	0.6220			16,0	133,0	83,0	63,0	48,0	65101	64901	
5/8	0.6250	15.88	11/16-16	16,0	133,0	83,0	63,0	48,0	55032	54832	
16,0 mm	0.6299			16,0	133,0	83,0	63,0	48,0	65102	64902	
21/32	0.6562	16.67	3/4-10	18,0	143,0	93,0	71,0	48,0	55033	54833	
11/16	0.6875	17.46	3/4-16	18,0	143,0	93,0	71,0	48,0	55034	54834	
3/4	0.7500	19.05	13/16-16	20,0	153,0	101,0	77,0	50,0	55035	54835	

FRACTIONAL
Hi-PerCarb®

Series 131N 3D & 5D Fractional	Hardness	Vc (sfm)		DC • in						
				1/8	3/16	1/4	3/8	1/2	5/8	3/4
ALUMINUM ALLOYS < 12% SI 6061, 2024, 7075	≤ 150 Bhn or ≤ 7 HRc	800 (640-960)	RPM	24448	16299	12224	8149	6112	4890	4075
			Fr	0.0055	0.0083	0.0110	0.0166	0.0221	0.0276	0.0331
			Feed (ipm)	135	135	135	135	135	135	135
ALUMINUM ALLOYS > 12% SI A356.0, 390.0, 319.0	≤ 125 Bhn or ≤ 77 HRb	600 (480-720)	RPM	18336	12224	9168	6112	4584	3667	3056
			Fr	0.0055	0.0082	0.0109	0.0164	0.0218	0.0273	0.0327
			Feed (ipm)	100	100	100	100	100	100	100
COPPER ALLOYS Alum Bronze, Muntz Brass, Naval Brass	≤ 175 Bhn or ≤ 16 HRc	550 (440-660)	RPM	16808	11205	8404	5603	4202	3362	2801
			Fr	0.0020	0.0030	0.0040	0.0061	0.0081	0.0101	0.0121
			Feed (ipm)	34	34	34	34	34	34	34
PLASTICS Acrylic, PVC, Polypropylene		450 (360-540)	RPM	13752	9168	6876	4584	3438	2750	2292
			Fr	0.0025	0.0037	0.0049	0.0074	0.0099	0.0124	0.0148
			Feed (ipm)	34	34	34	34	34	34	34

Bhn (Brinell) HRc (Rockwell C) HRb (Rockwell B)
 $rpm = Vc \times 3.82 / DC$
 $ipm = Fr \times rpm$
 reduce speed and feed for materials harder than listed
 refer to the SGS Tool Wizard® for complete technical information (www.kyocera-sgstool.com)

Series 131N 3D & 5D Metric	Hardness	Vc (m/min)	DC • mm							
			3	6	8	10	12	14	16	
ALUMINUM ALLOYS < 12% SI 6061, 2024, 7075	≤ 150 Bhn or ≤ 7 HRc	244	RPM	25851	12926	9694	7755	6463	5540	4847
		(195-293)	Fr	0.133	0.265	0.354	0.442	0.531	0.619	0.708
			Feed (mm/min)	3430	3430	3430	3430	3430	3430	3430
ALUMINUM ALLOYS > 12% SI A356.0, 390.0, 319.0	≤ 125 Bhn or ≤ 77 HRb	183	RPM	19388	9694	7271	5816	4847	4155	3635
		(146-219)	Fr	0.131	0.262	0.349	0.437	0.524	0.611	0.699
			Feed (mm/min)	2540	2540	2540	2540	2540	2540	2540
COPPER ALLOYS Alum Bronze, Muntz Brass, Navel Brass	≤ 175 Bhn or ≤ 16 HRc	168	RPM	17773	8886	6665	5332	4443	3808	3332
		(134-201)	Fr	0.049	0.097	0.130	0.162	0.194	0.227	0.259
			Feed (mm/min)	864	864	864	864	864	864	864
PLASTICS Acrylic, PVC, Polypropylene		137	RPM	14541	7271	5453	4362	3635	3116	2726
		(110-165)	Fr	0.059	0.119	0.158	0.198	0.238	0.277	0.317
			Feed (mm/min)	864	864	864	864	864	864	864

Bhn (Brinell) HRc (Rockwell C) HRb (Rockwell B)
 $rpm = (Vc \times 1000) / (DC \times 3.14)$
 $mm/min = Fr \times rpm$
 reduce speed and feed for materials harder than listed
 refer to the SGS Tool Wizard® for complete technical information (www.kyocera-sgstool.com)



5xD

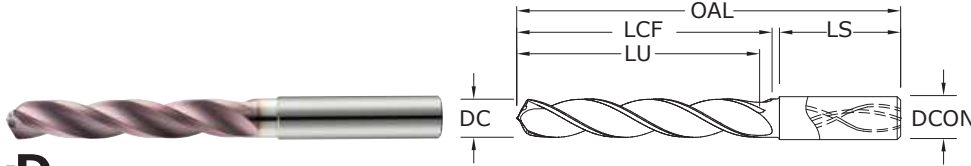

141K 5xD

FRACTIONAL & METRIC SERIES

- Triple margin design improves hole stability and size control while providing superior finish, roundness and cylindricity
- Self-stabilizing pyramid point design stabilizes the drill on contact with the workpiece
- Open flute structure efficiently transports chips while maintaining strength at high feed rates
- Sculpted gash allows chips to easily flow away from the drill center
- Recommended for materials ≤ 400 Bhn (≤ 43 HRC)

inch & mm									EDP NO.
CUTTING DIAMETER DC	DECIMAL EQUIV.	METRIC EQUIV.	TAP SIZE REFERENCE ONLY	SHANK DIAMETER DCON	OVERALL LENGTH OAL	FLUTE LENGTH LCF	CLEARED LENGTH LU	SHANK LENGTH LS	Ti-NAMITE-M (TM)
3,0 mm	0.1181			6,0	66,0	28,0	23,0	36,0	65160
3,1 mm	0.1220			6,0	66,0	28,0	23,0	36,0	65161
1/8	0.1250	3.18		6,0	66,0	28,0	23,0	36,0	55160
3,2 mm	0.1260		M3,5 X 0,35	6,0	66,0	28,0	23,0	36,0	65162
3,3 mm	0.1299		M4 X 0,7	6,0	66,0	28,0	23,0	36,0	65163
3,4 mm	0.1339			6,0	66,0	28,0	23,0	36,0	65164
#29	0.1360	3.45	8-32,8-36	6,0	66,0	28,0	23,0	36,0	55161
3,5 mm	0.1378		M4 X 0,5	6,0	66,0	28,0	23,0	36,0	65165
9/64	0.1406	3.57		6,0	66,0	28,0	23,0	36,0	55162
3,6 mm	0.1417		M4 X 0,35	6,0	66,0	28,0	23,0	36,0	65166
3,7 mm	0.1457		M4,5 X 0,75	6,0	66,0	28,0	23,0	36,0	65167
3,8 mm	0.1496		10-24	6,0	74,0	36,0	29,0	36,0	65168
3,9 mm	0.1535			6,0	74,0	36,0	29,0	36,0	65169
5/32	0.1562	3.97		6,0	74,0	36,0	29,0	36,0	55163
4,0 mm	0.1575		M4,5 X 0,5	6,0	74,0	36,0	29,0	36,0	65170
#21	0.1590	4.04	10-32	6,0	74,0	36,0	29,0	36,0	55164
4,1 mm	0.1614			6,0	74,0	36,0	29,0	36,0	65171
4,2 mm	0.1654		M5 / M5 x 0,75	6,0	74,0	36,0	29,0	36,0	65172
4,3 mm	0.1693			6,0	74,0	36,0	29,0	36,0	65173
11/64	0.1719	4.37		6,0	74,0	36,0	29,0	36,0	55165
4,4 mm	0.1732		12-24	6,0	74,0	36,0	29,0	36,0	65174
4,5 mm	0.1772		M5 X 0,5	6,0	74,0	36,0	29,0	36,0	65175
4,6 mm	0.1811		12-28	6,0	74,0	36,0	29,0	36,0	65176
4,7 mm	0.1850		12-32	6,0	74,0	36,0	29,0	36,0	65177
3/16	0.1875	4.76		6,0	82,0	44,0	35,0	36,0	55166
4,8 mm	0.1890		7/32-32	6,0	82,0	44,0	35,0	36,0	65178
4,9 mm	0.1929			6,0	82,0	44,0	35,0	36,0	65179
5,0 mm	0.1969		M6 X 1	6,0	82,0	44,0	35,0	36,0	65180
5,1 mm	0.2008		1/4-20	6,0	82,0	44,0	35,0	36,0	65181
13/64	0.2031	5.16		6,0	82,0	44,0	35,0	36,0	55167
5,2 mm	0.2047		M6 X 0,75	6,0	82,0	44,0	35,0	36,0	65182
5,3 mm	0.2087			6,0	82,0	44,0	35,0	36,0	65183
5,4 mm	0.2126			6,0	82,0	44,0	35,0	36,0	65184
5,5 mm	0.2165		M6 X 0,5	6,0	82,0	44,0	35,0	36,0	65185
7/32	0.2188	5.56	1/4-32	6,0	82,0	44,0	35,0	36,0	55168
5,6 mm	0.2205			6,0	82,0	44,0	35,0	36,0	65186

continued on next page

TOLERANCES (inch)

- ≤.1181 DIAMETER**
DC = +.0008/+0.0047
DCON = h₆
- >.1181-.2362 DIAMETER**
DC = +.00016/+0.00063
DCON = h₆
- >.2362-.3937 DIAMETER**
DC = +.00028/+0.00083
DCON = h₆
- >.3937-.7087 DIAMETER**
DC = +.00028/+0.00098
DCON = h₆
- >.7087-1.1811 DIAMETER**
DC = +.00031/+0.00114
DCON = h₆

TOLERANCES (mm)

- ≤3 DIAMETER**
DC = +0.002/+0.012
DCON = h₆
- >3-6 DIAMETER**
DC = +0.004/+0.016
DCON = h₆
- >6-10 DIAMETER**
DC = +0.006/+0.021
DCON = h₆
- >10-18 DIAMETER**
DC = +0.007/+0.025
DCON = h₆

CAST IRON

For patent information visit www.ksptpatents.com



141K 5xD

FRACTIONAL & METRIC SERIES

inch & mm									EDP NO.
CUTTING DIAMETER DC	DECIMAL EQUIV.	METRIC EQUIV.	TAP SIZE REFERENCE ONLY	SHANK DIAMETER DCON	OVERALL LENGTH OAL	FLUTE LENGTH LCF	CLEARED LENGTH LU	SHANK LENGTH LS	Ti-NAMITE-M (TM)
5,7 mm	0.2244			6,0	82,0	44,0	35,0	36,0	65187
5,8 mm	0.2283			6,0	82,0	44,0	35,0	36,0	65188
5,9 mm	0.2323			6,0	82,0	44,0	35,0	36,0	65189
15/64	0.2344	5.95		6,0	82,0	44,0	35,0	36,0	55169
6,0 mm	0.2362		M7 X 1	6,0	82,0	44,0	35,0	36,0	65190
6,1 mm	0.2402			8,0	91,0	53,0	43,0	36,0	65191
6,2 mm	0.2441		M7 X 0,75	8,0	91,0	53,0	43,0	36,0	65192
6,3 mm	0.2480			8,0	91,0	53,0	43,0	36,0	65193
1/4	0.2500	6.35		8,0	91,0	53,0	43,0	36,0	55170
6,4 mm	0.2520			8,0	91,0	53,0	43,0	36,0	65194
6,5 mm	0.2559			8,0	91,0	53,0	43,0	36,0	65195
F	0.2570	6.53	5/16-18	8,0	91,0	53,0	43,0	36,0	55171
6,6 mm	0.2598			8,0	91,0	53,0	43,0	36,0	65196
6,7 mm	0.2638			8,0	91,0	53,0	43,0	36,0	65197
17/64	0.2656	6.75	5/16-20	8,0	91,0	53,0	43,0	36,0	55172
6,8 mm	0.2677		M8 X 1,25	8,0	91,0	53,0	43,0	36,0	65198
6,9 mm	0.2717		5/16-24	8,0	91,0	53,0	43,0	36,0	65199
7,0 mm	0.2756		M8 X 1	8,0	91,0	53,0	43,0	36,0	65200
7,1 mm	0.2795			8,0	91,0	53,0	43,0	36,0	65201
9/32	0.2812	7.14	5/16-32	8,0	91,0	53,0	43,0	36,0	55173
7,2 mm	0.2835		M8 X 0,75	8,0	91,0	53,0	43,0	36,0	65202
7,3 mm	0.2874			8,0	91,0	53,0	43,0	36,0	65203
7,4 mm	0.2913			8,0	91,0	53,0	43,0	36,0	65204
7,5 mm	0.2953		M8 X 0,5	8,0	91,0	53,0	43,0	36,0	65205
19/64	0.2969	7.54		8,0	91,0	53,0	43,0	36,0	55174
7,6 mm	0.2992			8,0	91,0	53,0	43,0	36,0	65206
7,7 mm	0.3031			8,0	91,0	53,0	43,0	36,0	65207
7,8 mm	0.3071		M9 X 1,25	8,0	91,0	53,0	43,0	36,0	65208
7,9 mm	0.3110			8,0	91,0	53,0	43,0	36,0	65209
5/16	0.3125	7.94	3/8-16	8,0	91,0	53,0	43,0	36,0	55175
8,0 mm	0.3150		M9 X 1	8,0	91,0	53,0	43,0	36,0	65210
8,1 mm	0.3189			10,0	103,0	61,0	49,0	40,0	65211
8,2 mm	0.3228			10,0	103,0	61,0	49,0	40,0	65212
8,3 mm	0.3268			10,0	103,0	61,0	49,0	40,0	65213
21/64	0.3281	8.33	3/8-20	10,0	103,0	61,0	49,0	40,0	55176
8,4 mm	0.3307			10,0	103,0	61,0	49,0	40,0	65214
Q	0.3320	8.43	3/8-24	10,0	103,0	61,0	49,0	40,0	55177
8,5 mm	0.3346		M10 X 1,5	10,0	103,0	61,0	49,0	40,0	65215
8,6 mm	0.3386			10,0	103,0	61,0	49,0	40,0	65216
8,7 mm	0.3425			10,0	103,0	61,0	49,0	40,0	65217
11/32	0.3438	8.73	3/8-32	10,0	103,0	61,0	49,0	40,0	55178
8,8 mm	0.3465		M10 X 1,25	10,0	103,0	61,0	49,0	40,0	65218
8,9 mm	0.3504			10,0	103,0	61,0	49,0	40,0	65219
9,0 mm	0.3543		M10 X 1	10,0	103,0	61,0	49,0	40,0	65220
9,1 mm	0.3583			10,0	103,0	61,0	49,0	40,0	65221
23/64	0.3594	9.13		10,0	103,0	61,0	49,0	40,0	55179

CONTINUED

continued on next page

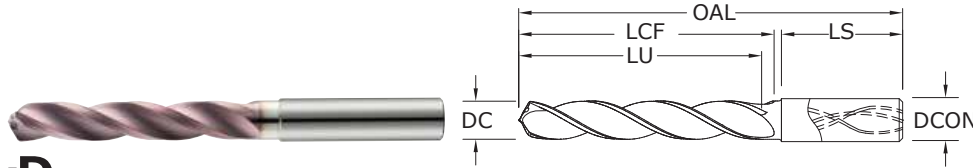

141K 5xD

FRACTIONAL & METRIC SERIES

- Triple margin design improves hole stability and size control while providing superior finish, roundness and cylindricity
- Self-stabilizing pyramid point design stabilizes the drill on contact with the workpiece
- Open flute structure efficiently transports chips while maintaining strength at high feed rates
- Sculpted gash allows chips to easily flow away from the drill center
- Recommended for materials ≤ 400 Bhn (≤ 43 HRC)

inch & mm									EDP NO.
CUTTING DIAMETER DC	DECIMAL EQUIV.	METRIC EQUIV.	TAP SIZE REFERENCE ONLY	SHANK DIAMETER DCON	OVERALL LENGTH OAL	FLUTE LENGTH LCF	CLEARED LENGTH LU	SHANK LENGTH LS	Ti-NAMITE-M (TM)
9,2 mm	0.3622		M10 X 0,75	10,0	103,0	61,0	49,0	40,0	65222
9,3 mm	0.3661			10,0	103,0	61,0	49,0	40,0	65223
U	0.3680	9.35	7/16-14	10,0	103,0	61,0	49,0	40,0	55180
9,4 mm	0.3701			10,0	103,0	61,0	49,0	40,0	65224
9,5 mm	0.3740		M11 / M10 X 0,5	10,0	103,0	61,0	49,0	40,0	65225
3/8	0.3750	9.53		10,0	103,0	61,0	49,0	40,0	55181
9,6 mm	0.3780			10,0	103,0	61,0	49,0	40,0	65226
9,7 mm	0.3819			10,0	103,0	61,0	49,0	40,0	65227
9,8 mm	0.3858			10,0	103,0	61,0	49,0	40,0	65228
9,9 mm	0.3898			10,0	103,0	61,0	49,0	40,0	65229
25/64	0.3906	9.92	7/16-20	10,0	103,0	61,0	49,0	40,0	55182
10,0 mm	0.3937			10,0	103,0	61,0	49,0	40,0	65230
10,1 mm	0.3976			12,0	118,0	71,0	56,0	45,0	65231
10,2 mm	0.4016		M12 X 1,75	12,0	118,0	71,0	56,0	45,0	65232
10,3 mm	0.4055			12,0	118,0	71,0	56,0	45,0	65233
13/32	0.4062	10.32		12,0	118,0	71,0	56,0	45,0	55183
10,4 mm	0.4094			12,0	118,0	71,0	56,0	45,0	65234
10,5 mm	0.4134		M12 X 1,5	12,0	118,0	71,0	56,0	45,0	65235
10,6 mm	0.4173			12,0	118,0	71,0	56,0	45,0	65236
10,7 mm	0.4213			12,0	118,0	71,0	56,0	45,0	65237
27/64	0.4219	10.72	1/2-13	12,0	118,0	71,0	56,0	45,0	55184
10,8 mm	0.4252		M12 X 1,25	12,0	118,0	71,0	56,0	45,0	65238
10,9 mm	0.4291			12,0	118,0	71,0	56,0	45,0	65239
11,0 mm	0.4331		M12 X 1	12,0	118,0	71,0	56,0	45,0	65240
11,1 mm	0.4370			12,0	118,0	71,0	56,0	45,0	65241
7/16	0.4375	11.11	1/4-18NPT	12,0	118,0	71,0	56,0	45,0	55185
11,2 mm	0.4409			12,0	118,0	71,0	56,0	45,0	65242
11,3 mm	0.4449			12,0	118,0	71,0	56,0	45,0	65243
11,4 mm	0.4488			12,0	118,0	71,0	56,0	45,0	65244
11,5 mm	0.4528		M12 X 0,5	12,0	118,0	71,0	56,0	45,0	65245
11,6 mm	0.4567			12,0	118,0	71,0	56,0	45,0	65246
11,7 mm	0.4606			12,0	118,0	71,0	56,0	45,0	65247
11,8 mm	0.4646			12,0	118,0	71,0	56,0	45,0	65248
11,9 mm	0.4685			12,0	118,0	71,0	56,0	45,0	65249
15/32	0.4688	11.91	1/2-28	12,0	118,0	71,0	56,0	45,0	55186
12,0 mm	0.4724		M14 X 2	12,0	118,0	71,0	56,0	45,0	65250

continued on next page

TOLERANCES (inch)

- ≤ 1.181 DIAMETER**
DC = +.00008/+0.00047
DCON = h_6
- > 1.181–.2362 DIAMETER**
DC = +.00016/+0.00063
DCON = h_6
- > .2362–.3937 DIAMETER**
DC = +.00028/+0.00083
DCON = h_6
- > .3937–.7087 DIAMETER**
DC = +.00028/+0.00098
DCON = h_6
- > .7087–1.1811 DIAMETER**
DC = +.00031/+0.00114
DCON = h_6

TOLERANCES (mm)

- ≤ 3 DIAMETER**
DC = +0.004/+0.012
DCON = h_6
- > 3–6 DIAMETER**
DC = +0.004/+0.016
DCON = h_6
- > 6–10 DIAMETER**
DC = +0.006/+0.021
DCON = h_6
- > 10–18 DIAMETER**
DC = +0.007/+0.025
DCON = h_6

CAST IRON

For patent information visit www.ksptpatents.com



141K 5xD

FRACTIONAL & METRIC SERIES

inch & mm									EDP NO.
CUTTING DIAMETER DC	DECIMAL EQUIV.	METRIC EQUIV.	TAP SIZE REFERENCE ONLY	SHANK DIAMETER DCON	OVERALL LENGTH OAL	FLUTE LENGTH LCF	CLEARED LENGTH LU	SHANK LENGTH LS	Ti-NAMITE-M (TM)
31/64	0.4844	12.30	9/16-12	14,0	124,0	77,0	60,0	45,0	55187
12,5 mm	0.4921		M14 X 1,5	14,0	124,0	77,0	60,0	45,0	65251
1/2	0.5000	12.70		14,0	124,0	77,0	60,0	45,0	55188
12,8 mm	0.5039		M14 X 1,25	14,0	124,0	77,0	60,0	45,0	65252
13,0 mm	0.5118		M14 X 1	14,0	124,0	77,0	60,0	45,0	65253
33/64	0.5156	13.10	9/16-18	14,0	124,0	77,0	60,0	45,0	55189
13,5 mm	0.5315		5/8-11	14,0	124,0	77,0	60,0	45,0	65254
13,8 mm	0.5433			14,0	124,0	77,0	60,0	45,0	65255
14,0 mm	0.5512		M16 X 2	14,0	124,0	77,0	60,0	45,0	65256
9/16	0.5625	14.29		16,0	133,0	83,0	63,0	48,0	55190
14,5 mm	0.5709		M16 X 1,5	16,0	133,0	83,0	63,0	48,0	65257
37/64	0.5781	14.68	5/8-18	16,0	133,0	83,0	63,0	48,0	55191
14,8 mm	0.5827			16,0	133,0	83,0	63,0	48,0	65258
15,0 mm	0.5906		M16 X 1	16,0	133,0	83,0	63,0	48,0	65259
15,5 mm	0.6102		M18 X 2,5	16,0	133,0	83,0	63,0	48,0	65260
15,8 mm	0.6220			16,0	133,0	83,0	63,0	48,0	65261
5/8	0.6250	15.88	11/16-16	16,0	133,0	83,0	63,0	48,0	55192
16,0 mm	0.6299			16,0	133,0	83,0	63,0	48,0	65262
21/32	0.6562	16.67	3/4-10	18,0	143,0	93,0	71,0	48,0	55193
11/16	0.6875	17.46	3/4-16	18,0	143,0	93,0	71,0	48,0	55194
3/4	0.7500	19.05	13/16-16	20,0	153,0	101,0	77,0	50,0	55195

CONTINUED

FRACTIONAL
Hi-PerCarb®

Series 141K 5D Fractional	Hardness	Vc (sfm)		DC • in						
				1/8	3/16	1/4	3/8	1/2	5/8	3/4
GRAY CAST IRON FERRITIC ASTM A48: CLASS 20 SAE J431C: GRADE 1800	≤ 150 Bhn or ≤ 80 HRb	450 (360-540)	RPM	13752	9168	6876	4584	3438	2750	2292
			Fr	0.0049	0.0074	0.0099	0.0148	0.0198	0.0247	0.0297
			Feed (ipm)	68	68	68	68	68	68	68
GRAY CAST IRON PEARLITIC ASTM A48: CLASS 30, 35, 40 SAE J431C: GRADE 3000	≤ 220 Bhn or ≤ 19 HRc	375 (300-450)	RPM	11460	7640	5730	3820	2865	2292	1910
			Fr	0.0039	0.0059	0.0079	0.0118	0.0157	0.0196	0.0236
			Feed (ipm)	45	45	45	45	45	45	45
COMPACTED GRAPHITE IRON	≤ 250 Bhn or ≤ 25 HRc	325 (260-390)	RPM	9932	6621	4966	3311	2483	1986	1655
			Fr	0.0039	0.0059	0.0079	0.0118	0.0157	0.0196	0.0236
			Feed (ipm)	39	39	39	39	39	39	39
MALLEABLE CAST IRON FERRITIC ASTM A220: GRADE 40010 SAE J158: GRADE M4504	≤ 160 Bhn or ≤ 3 HRc	450 (360-540)	RPM	13752	9168	6876	4584	3438	2750	2292
			Fr	0.0049	0.0074	0.0099	0.0148	0.0198	0.0247	0.0297
			Feed (ipm)	68	68	68	68	68	68	68
MALLEABLE CAST IRON MARTENSITE ASTM A220: GRADE 90001 SAE J158: GRADE M8501	≤ 320 Bhn or ≤ 34 HRc	250 (200-300)	RPM	7640	5093	3820	2547	1910	1528	1273
			Fr	0.0031	0.0047	0.0063	0.0094	0.0126	0.0157	0.0188
			Feed (ipm)	24	24	24	24	24	24	24

Bhn (Brinell) HRc (Rockwell C) HRb (Rockwell B)
 $rpm = Vc \times 3.82 / DC$
 $ipm = Fr \times rpm$
 reduce speed and feed for materials harder than listed
 refer to the SGS Tool Wizard® for complete technical information (www.kyocera-sgstool.com)

Series 141K 5D Metric	Hardness	Vc (m/min)		DC • mm						
				3	6	8	10	12	14	16
GRAY CAST IRON FERRITIC ASTM A48: CLASS 20 SAE J431C: GRADE 1800	≤ 150 Bhn or ≤ 80 HRb	137 (110-165)	RPM	14541	7271	5453	4362	3635	3116	2726
			Fr	0.119	0.237	0.316	0.395	0.475	0.554	0.633
			Feed (mm/min)	1725	1725	1725	1725	1725	1725	1725
GRAY CAST IRON PEARLITIC ASTM A48: CLASS 30, 35, 40 SAE J431C: GRADE 3000	≤ 220 Bhn or ≤ 19 HRc	114 (91-137)	RPM	12118	6059	4544	3635	3029	2597	2272
			Fr	0.094	0.189	0.252	0.315	0.378	0.441	0.504
			Feed (mm/min)	1145	1145	1145	1145	1145	1145	1145
COMPACTED GRAPHITE IRON	≤ 250 Bhn or ≤ 25 HRc	99 (79-119)	RPM	10502	5251	3938	3151	2626	2250	1969
			Fr	0.094	0.189	0.251	0.314	0.377	0.440	0.503
			Feed (mm/min)	990	990	990	990	990	990	990
MALLEABLE CAST IRON FERRITIC ASTM A220: GRADE 40010 SAE J158: GRADE M4504	≤ 160 Bhn or ≤ 3 HRc	137 (110-165)	RPM	14541	7271	5453	4362	3635	3116	2726
			Fr	0.119	0.237	0.316	0.395	0.475	0.554	0.633
			Feed (mm/min)	1725	1725	1725	1725	1725	1725	1725
MALLEABLE CAST IRON MARTENSITE ASTM A220: GRADE 90001 SAE J158: GRADE M8501	≤ 320 Bhn or ≤ 34 HRc	76 (61-91)	RPM	8078	4039	3029	2424	2020	1731	1515
			Fr	0.076	0.151	0.201	0.252	0.302	0.352	0.403
			Feed (mm/min)	610	610	610	610	610	610	610

(Brinell) HRc (Rockwell C) HRb (Rockwell B)
 $rpm = (Vc \times 1000) / (DC \times 3.14)$
 $mm/min = Fr \times rpm$
 reduce speed and feed for materials harder than listed
 refer to the SGS Tool Wizard® for complete technical information (www.kyocera-sgstool.com)



5xD

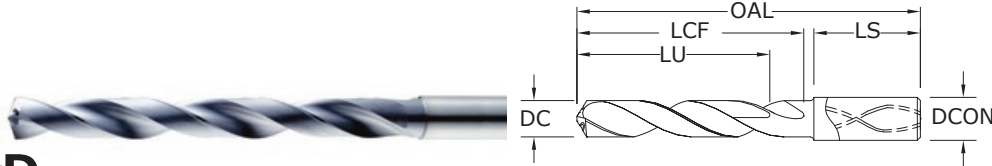

140 5xD

FRACTIONAL & METRIC SERIES

- Coolant through design promotes controlled and consistent operating temperatures improving coolant flow to the cut while maintaining strength
- Split point geometry for improved drill penetration and accuracy
- Controlled edge honing for longevity
- Negative corner position strengthens and protects
- Recommended for materials ≤ 60 HRc (≤ 654 Bhn)

inch & mm									EDP NO.
CUTTING DIAMETER DC	DECIMAL EQUIV.	METRIC EQUIV.	TAP SIZE REFERENCE ONLY	SHANK DIAMETER DCON	OVERALL LENGTH OAL	FLUTE LENGTH LCF	CLEARED LENGTH LU	SHANK LENGTH LS	Ti-NAMITE-A (AITiN)
3,0 mm	0.1181			6,0	66,0	28,0	23,0	36,0	63901
3,1 mm	0.1220			6,0	66,0	28,0	23,0	36,0	63902
1/8	0.1250	3.18		6,0	66,0	28,0	23,0	36,0	51901
3,2 mm	0.1260		M3,5 X 0,35	6,0	66,0	28,0	23,0	36,0	63903
3,3 mm	0.1299		M4 X 0,7	6,0	66,0	28,0	23,0	36,0	63904
3,4 mm	0.1339			6,0	66,0	28,0	23,0	36,0	63905
#29	0.1360	3.45	8-32,8-36	6,0	66,0	28,0	23,0	36,0	51902
3,5 mm	0.1378		M4 X 0,5	6,0	66,0	28,0	23,0	36,0	63906
9/64	0.1406	3.57		6,0	66,0	28,0	23,0	36,0	51903
3,6 mm	0.1417		M4 X 0,35	6,0	66,0	28,0	23,0	36,0	63907
3,7 mm	0.1457		M4,5 X 0,75	6,0	66,0	28,0	23,0	36,0	63908
3,8 mm	0.1496		10-24	6,0	74,0	36,0	29,0	36,0	51904
3,9 mm	0.1535			6,0	74,0	36,0	29,0	36,0	63909
5/32	0.1562	3.97		6,0	74,0	36,0	29,0	36,0	51905
4,0 mm	0.1575		M4,5 X 0,5	6,0	74,0	36,0	29,0	36,0	63910
#21	0.1590	4.04	10-32	6,0	74,0	36,0	29,0	36,0	51906
4,1 mm	0.1614			6,0	74,0	36,0	29,0	36,0	63911
4,2 mm	0.1654		M5 / M5 x 0,75	6,0	74,0	36,0	29,0	36,0	63912
4,3 mm	0.1693			6,0	74,0	36,0	29,0	36,0	63913
11/64	0.1719	4.37		6,0	74,0	36,0	29,0	36,0	51907
4,4 mm	0.1732		12-24	6,0	74,0	36,0	29,0	36,0	63914
4,5 mm	0.1772		M5 X 0,5	6,0	74,0	36,0	29,0	36,0	63915
4,6 mm	0.1811		12-28	6,0	74,0	36,0	29,0	36,0	63916
4,7 mm	0.1850		12-32	6,0	74,0	36,0	29,0	36,0	63917
3/16	0.1875	4.76		6,0	82,0	44,0	35,0	36,0	51908
4,8 mm	0.1890		7/32-32	6,0	82,0	44,0	35,0	36,0	63918
4,9 mm	0.1929			6,0	82,0	44,0	35,0	36,0	63919
5,0 mm	0.1969		M6 X 1	6,0	82,0	44,0	35,0	36,0	63920
5,1 mm	0.2008		1/4-20	6,0	82,0	44,0	35,0	36,0	63900
13/64	0.2031	5.16		6,0	82,0	44,0	35,0	36,0	51910
5,2 mm	0.2047		M6 X 0,75	6,0	82,0	44,0	35,0	36,0	63921
5,3 mm	0.2087			6,0	82,0	44,0	35,0	36,0	63922
5,4 mm	0.2126			6,0	82,0	44,0	35,0	36,0	63998
5,5 mm	0.2165		M6 X 0,5	6,0	82,0	44,0	35,0	36,0	63923

continued on next page

TOLERANCES (inch)

- ≤.1181 DIAMETER
DC = +.00008/+0.00047
DCON = h₆
- >.1181-.2362 DIAMETER
DC = +.00016/+0.00063
DCON = h₆
- >.2362-.3937 DIAMETER
DC = +.00024/+0.00083
DCON = h₆
- >.3937-.7087 DIAMETER
DC = +.00028/+0.00098
DCON = h₆
- >.7087-1.1811 DIAMETER
DC = +.00031/+0.00114
DCON = h₆

TOLERANCES (mm)

- ≤3 DIAMETER
DC = +0,002/+0,012
DCON = h₆
- >3-6 DIAMETER
DC = +0,004/+0,016
DCON = h₆
- >6-10 DIAMETER
DC = +0,006/+0,021
DCON = h₆
- >10-18 DIAMETER
DC = +0,007/+0,025
DCON = h₆

- STEELS
- STAINLESS STEELS
- CAST IRON
- HIGH TEMP ALLOYS
- TITANIUM
- NON-FERROUS
- HARDENED STEELS

For patent information visit www.ksptpatents.com

140 5xD

FRACTIONAL & METRIC SERIES

CUTTING DIAMETER DC	DECIMAL EQUIV.	METRIC EQUIV.	inch & mm						EDP NO.	
			TAP SIZE REFERENCE ONLY	SHANK DIAMETER DCON	OVERALL LENGTH OAL	FLUTE LENGTH LCF	CLEARED LENGTH LU	SHANK LENGTH LS	Ti-NAMITE-A (AITIN)	
7/32	0.2188	5.56	1/4-32	6,0	82,0	44,0	35,0	36,0	51912	
5,6 mm	0.2205			6,0	82,0	44,0	35,0	36,0	63924	
5,7 mm	0.2244			6,0	82,0	44,0	35,0	36,0	63925	
5,8 mm	0.2283			6,0	82,0	44,0	35,0	36,0	63926	
5,9 mm	0.2323			6,0	82,0	44,0	35,0	36,0	63927	
15/64	0.2344	5.95		6,0	82,0	44,0	35,0	36,0	51913	
6,0 mm	0.2362		M7 X 1	6,0	82,0	44,0	35,0	36,0	63928	
6,1 mm	0.2402			8,0	91,0	53,0	43,0	36,0	63929	
6,2 mm	0.2441		M7 X 0,75	8,0	91,0	53,0	43,0	36,0	63930	
6,3 mm	0.2480			8,0	91,0	53,0	43,0	36,0	63931	
1/4	0.2500	6.35		8,0	91,0	53,0	43,0	36,0	51914	
6,4 mm	0.2520			8,0	91,0	53,0	43,0	36,0	63932	
6,5 mm	0.2559			8,0	91,0	53,0	43,0	36,0	63933	
F	0.2570	6.53	5/16-18	8,0	91,0	53,0	43,0	36,0	51915	
6,6 mm	0.2598			8,0	91,0	53,0	43,0	36,0	63934	
6,7 mm	0.2638			8,0	91,0	53,0	43,0	36,0	63935	
17/64	0.2656	6.75	5/16-20	8,0	91,0	53,0	43,0	36,0	51916	
6,8 mm	0.2677		M8 X 1,25	8,0	91,0	53,0	43,0	36,0	63936	
6,9 mm	0.2717		5/16-24	8,0	91,0	53,0	43,0	36,0	63999	
7,0 mm	0.2756		M8 X 1	8,0	91,0	53,0	43,0	36,0	63937	
7,1 mm	0.2795			8,0	91,0	53,0	43,0	36,0	63938	
9/32	0.2812	7.14	5/16-32	8,0	91,0	53,0	43,0	36,0	51918	
7,2 mm	0.2835		M8 X 0,75	8,0	91,0	53,0	43,0	36,0	63939	
7,3 mm	0.2874			8,0	91,0	53,0	43,0	36,0	63940	
7,4 mm	0.2913			8,0	91,0	53,0	43,0	36,0	63941	
7,5 mm	0.2953		M8 X 0,5	8,0	91,0	53,0	43,0	36,0	63942	
19/64	0.2969	7.54		8,0	91,0	53,0	43,0	36,0	51919	
7,6 mm	0.2992			8,0	91,0	53,0	43,0	36,0	63943	
7,7 mm	0.3031			8,0	91,0	53,0	43,0	36,0	63944	
7,8 mm	0.3071		M9 X 1,25	8,0	91,0	53,0	43,0	36,0	63945	
7,9 mm	0.3110			8,0	91,0	53,0	43,0	36,0	63946	
5/16	0.3125	7.94	3/8-16	8,0	91,0	53,0	43,0	36,0	51920	
8,0 mm	0.3150		M9 X 1	8,0	91,0	53,0	43,0	36,0	63947	
8,1 mm	0.3189			10,0	103,0	61,0	49,0	40,0	63948	
8,2 mm	0.3228			10,0	103,0	61,0	49,0	40,0	63949	
8,3 mm	0.3268			10,0	103,0	61,0	49,0	40,0	63950	
21/64	0.3281	8.33	3/8-20	10,0	103,0	61,0	49,0	40,0	51921	
8,4 mm	0.3307			10,0	103,0	61,0	49,0	40,0	63951	
Q	0.3320	8.43	3/8-24	10,0	103,0	61,0	49,0	40,0	51922	
8,5 mm	0.3346		M10 X 1,5	10,0	103,0	61,0	49,0	40,0	63952	
8,6 mm	0.3386			10,0	103,0	61,0	49,0	40,0	63953	
8,7 mm	0.3425			10,0	103,0	61,0	49,0	40,0	63954	

continued on next page

CONTINUED



5xD

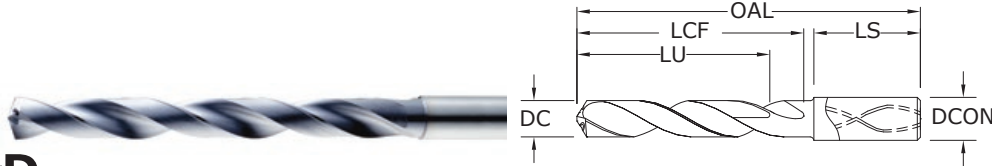

140 5xD

FRACTIONAL & METRIC SERIES

- Coolant through design promotes controlled and consistent operating temperatures improving coolant flow to the cut while maintaining strength
- Split point geometry for improved drill penetration and accuracy
- Controlled edge honing for longevity
- Negative corner position strengthens and protects
- Recommended for materials ≤ 60 HRc (≤ 654 Bhn)

inch & mm										EDP NO.
CUTTING DIAMETER DC	DECIMAL EQUIV.	METRIC EQUIV.	TAP SIZE REFERENCE ONLY	SHANK DIAMETER DCON	OVERALL LENGTH OAL	FLUTE LENGTH LCF	CLEARED LENGTH LU	SHANK LENGTH LS	Ti-NAMITE-A (AlTiN)	
11/32	0.3438	8.73	3/8-32	10,0	103,0	61,0	49,0	40,0	51923	
8,8 mm	0.3465		M10 X 1,25	10,0	103,0	61,0	49,0	40,0	63955	
8,9 mm	0.3504			10,0	103,0	61,0	49,0	40,0	63956	
9,0 mm	0.3543		M10 X 1	10,0	103,0	61,0	49,0	40,0	63957	
9,1 mm	0.3583			10,0	103,0	61,0	49,0	40,0	63958	
23/64	0.3594	9.13		10,0	103,0	61,0	49,0	40,0	51924	
9,2 mm	0.3622		M10 X 0,75	10,0	103,0	61,0	49,0	40,0	63959	
9,3 mm	0.3661			10,0	103,0	61,0	49,0	40,0	63960	
U	0.3680	9.35	7/16-14	10,0	103,0	61,0	49,0	40,0	51925	
9,4 mm	0.3701			10,0	103,0	61,0	49,0	40,0	63961	
9,5 mm	0.3740		M11 / M10 X 0,5	10,0	103,0	61,0	49,0	40,0	63962	
3/8	0.3750	9.53		10,0	103,0	61,0	49,0	40,0	51926	
9,6 mm	0.3780			10,0	103,0	61,0	49,0	40,0	63963	
9,7 mm	0.3819			10,0	103,0	61,0	49,0	40,0	63964	
9,8 mm	0.3858			10,0	103,0	61,0	49,0	40,0	63965	
9,9 mm	0.3898			10,0	103,0	61,0	49,0	40,0	63966	
25/64	0.3906	9.92	7/16-20	10,0	103,0	61,0	49,0	40,0	51927	
10,0 mm	0.3937			10,0	103,0	61,0	49,0	40,0	63967	
10,1 mm	0.3976			12,0	118,0	71,0	56,0	45,0	63968	
10,2 mm	0.4016		M12 X 1,75	12,0	118,0	71,0	56,0	45,0	63969	
10,3 mm	0.4055			12,0	118,0	71,0	56,0	45,0	63970	
13/32	0.4062	10.32		12,0	118,0	71,0	56,0	45,0	51928	
10,4 mm	0.4094			12,0	118,0	71,0	56,0	45,0	63971	
10,5 mm	0.4134		M12 X 1,5	12,0	118,0	71,0	56,0	45,0	63972	
10,6 mm	0.4173			12,0	118,0	71,0	56,0	45,0	63973	
10,7 mm	0.4213			12,0	118,0	71,0	56,0	45,0	63974	
27/64	0.4219	10.72	1/2-13	12,0	118,0	71,0	56,0	45,0	51929	
10,8 mm	0.4252		M12 X 1,25	12,0	118,0	71,0	56,0	45,0	63975	
10,9 mm	0.4291			12,0	118,0	71,0	56,0	45,0	63976	
11,0 mm	0.4331		M12 X 1	12,0	118,0	71,0	56,0	45,0	63977	
11,1 mm	0.4370			12,0	118,0	71,0	56,0	45,0	63978	
7/16	0.4375	11.11	1/4-18NPT	12,0	118,0	71,0	56,0	45,0	51930	
11,2 mm	0.4409			12,0	118,0	71,0	56,0	45,0	63979	
11,3 mm	0.4449			12,0	118,0	71,0	56,0	45,0	63980	

continued on next page

TOLERANCES (inch)

- $\leq .1181$ DIAMETER
DC = +.00008/+0.00047
DCON = h_6
- $>.1181-.2362$ DIAMETER
DC = +.00016/+0.00063
DCON = h_6
- $>.2362-.3937$ DIAMETER
DC = +.00024/+0.00083
DCON = h_6
- $>.3937-.7087$ DIAMETER
DC = +.00028/+0.00098
DCON = h_6
- $>.7087-1.1811$ DIAMETER
DC = +.00031/+0.00114
DCON = h_6

TOLERANCES (mm)

- ≤ 3 DIAMETER
DC = +0,002/+0,012
DCON = h_6
- $>3-6$ DIAMETER
DC = +0,004/+0,016
DCON = h_6
- $>6-10$ DIAMETER
DC = +0,006/+0,021
DCON = h_6
- $>10-18$ DIAMETER
DC = +0,007/+0,025
DCON = h_6

- STEELS
- STAINLESS STEELS
- CAST IRON
- HIGH TEMP ALLOYS
- TITANIUM
- NON-FERROUS
- HARDENED STEELS

For patent information visit www.ksptpatents.com

140 5xD

FRACTIONAL & METRIC SERIES

CUTTING DIAMETER DC	DECIMAL EQUIV.	METRIC EQUIV.	inch & mm						EDP NO.
			TAP SIZE REFERENCE ONLY	SHANK DIAMETER DCON	OVERALL LENGTH OAL	FLUTE LENGTH LCF	CLEARED LENGTH LU	SHANK LENGTH LS	Ti-NAMITE-A (AITiN)
11,4 mm	0.4488			12,0	118,0	71,0	56,0	45,0	63981
11,5 mm	0.4528		M12 X 0,5	12,0	118,0	71,0	56,0	45,0	64000
11,6 mm	0.4567			12,0	118,0	71,0	56,0	45,0	63982
11,7 mm	0.4606			12,0	118,0	71,0	56,0	45,0	63983
11,8 mm	0.4646			12,0	118,0	71,0	56,0	45,0	63984
11,9 mm	0.4685			12,0	118,0	71,0	56,0	45,0	63985
15/32	0.4688	11.91	1/2-28	12,0	118,0	71,0	56,0	45,0	51932
12,0 mm	0.4724		M14 X 2	12,0	118,0	71,0	56,0	45,0	63986
31/64	0.4844	12.30	9/16-12	14,0	124,0	77,0	60,0	45,0	51933
12,5 mm	0.4921		M14 X 1,5	14,0	124,0	77,0	60,0	45,0	63987
1/2	0.5000	12.70		14,0	124,0	77,0	60,0	45,0	51934
12,8 mm	0.5039		M14 X 1,25	14,0	124,0	77,0	60,0	45,0	63988
13,0 mm	0.5118		M14 X 1	14,0	124,0	77,0	60,0	45,0	63989
33/64	0.5156	13.10	9/16-18	14,0	124,0	77,0	60,0	45,0	51935
13,5 mm	0.5315		5/8-11	14,0	124,0	77,0	60,0	45,0	64001
13,8 mm	0.5433			14,0	124,0	77,0	60,0	45,0	63990
14,0 mm	0.5512		M16 X 2	14,0	124,0	77,0	60,0	45,0	63991
9/16	0.5625	14.29		16,0	133,0	83,0	63,0	48,0	51937
14,5 mm	0.5709		M16 X 1,5	16,0	133,0	83,0	63,0	48,0	63992
37/64	0.5781	14.68	5/8-18	16,0	133,0	83,0	63,0	48,0	51938
14,8 mm	0.5827			16,0	133,0	83,0	63,0	48,0	63993
15,0 mm	0.5906		M16 X 1	16,0	133,0	83,0	63,0	48,0	63994
15,5 mm	0.6102		M18 X 2,5	16,0	133,0	83,0	63,0	48,0	63995
15,8 mm	0.6220			16,0	133,0	83,0	63,0	48,0	63996
5/8	0.6250	15.88	11/16-16	16,0	133,0	83,0	63,0	48,0	51939
16,0 mm	0.6299			16,0	133,0	83,0	63,0	48,0	63997
21/32	0.6562	16.67	3/4-10	18,0	143,0	93,0	71,0	48,0	51940
11/16	0.6875	17.46	3/4-16	18,0	143,0	93,0	71,0	48,0	51941
3/4	0.7500	19.05	13/16-16	20,0	153,0	101,0	77,0	50,0	51942

CONTINUED

Series 140 5D Fractional	Hardness	Vc (sfm)	DC • in								
			1/8	3/16	1/4	3/8	1/2	5/8	3/4		
P CARBON STEELS 1018, 1040, 1080, 1090, 10L50, 1140, 1212, 12L15, 1525, 1536	≤ 175 Bhn or ≤ 7 HRc	425	RPM	12988	8659	6494	4329	3247	2598	2165	
		(340-510)	Fr	0.0039	0.0059	0.0079	0.0118	0.0157	0.0196	0.0236	
			Feed (ipm)	51.0	51.0	51.0	51.0	51.0	51.0	51.0	
	≤ 275 Bhn or ≤ 28 HRc	380	RPM	11613	7742	5806	3871	2903	2323	1935	
		(304-456)	Fr	0.0035	0.0053	0.0071	0.0106	0.0141	0.0177	0.0212	
			Feed (ipm)	41.0	41.0	41.0	41.0	41.0	41.0	41.0	
	≤ 425 Bhn or ≤ 45 HRc	220	RPM	6723	4482	3362	2241	1681	1345	1121	
		(176-264)	Fr	0.0030	0.0045	0.0059	0.0089	0.0119	0.0149	0.0178	
			Feed (ipm)	20.0	20.0	20.0	20.0	20.0	20.0	20.0	
	M ALLOY STEELS 4140, 4150, 4320, 5120, 5150, 8630, 86L20, 50100	≤ 275 Bhn or ≤ 28 HRc	330	RPM	10085	6723	5042	3362	2521	2017	1681
			(264-396)	Fr	0.0030	0.0045	0.0059	0.0089	0.0119	0.0149	0.0178
				Feed (ipm)	30.0	30.0	30.0	30.0	30.0	30.0	30.0
≤ 375 Bhn or ≤ 40 HRc		200	RPM	6112	4075	3056	2037	1528	1222	1019	
		(160-240)	Fr	0.0025	0.0038	0.0051	0.0076	0.0101	0.0127	0.0152	
			Feed (ipm)	15.5	15.5	15.5	15.5	15.5	15.5	15.5	
≤ 450 Bhn or ≤ 48 HRc		140	RPM	4278	2852	2139	1426	1070	856	713	
		(112-168)	Fr	0.0018	0.0027	0.0036	0.0054	0.0072	0.0090	0.0108	
			Feed (ipm)	7.7	7.7	7.7	7.7	7.7	7.7	7.7	
K STAINLESS STEELS (FREE MACHINING) 303, 416, 420F, 430F, 440F		≤ 185 Bhn or ≤ 9 HRc	305	RPM	9321	6214	4660	3107	2330	1864	1553
			(244-366)	Fr	0.0026	0.0039	0.0051	0.0077	0.0103	0.0129	0.0154
				Feed (ipm)	24.0	24.0	24.0	24.0	24.0	24.0	24.0
	≤ 275 Bhn or ≤ 28 HRc	195	RPM	5959	3973	2980	1986	1490	1192	993	
		(156-234)	Fr	0.0020	0.0030	0.0040	0.0060	0.0081	0.0101	0.0121	
			Feed (ipm)	12.0	12.0	12.0	12.0	12.0	12.0	12.0	
	K STAINLESS STEELS (DIFFICULT) 304, 316, 321, 13-8 PH, 15-5PH, 17-4 PH, Custom 450	≤ 275 Bhn or ≤ 28 HRc	150	RPM	4584	3056	2292	1528	1146	917	764
			(120-180)	Fr	0.0020	0.0030	0.0040	0.0060	0.0079	0.0099	0.0119
				Feed (ipm)	9.1	9.1	9.1	9.1	9.1	9.1	9.1
		≤ 375 Bhn or ≤ 40 HRc	110	RPM	3362	2241	1681	1121	840	672	560
			(88-132)	Fr	0.0018	0.0027	0.0036	0.0054	0.0071	0.0089	0.0107
				Feed (ipm)	6.0	6.0	6.0	6.0	6.0	6.0	6.0
K CAST IRONS Gray, Malleable, Ductile		≤ 220 Bhn or ≤ 19 HRc	360	RPM	11002	7334	5501	3667	2750	2200	1834
			(288-432)	Fr	0.0045	0.0068	0.0091	0.0136	0.0182	0.0227	0.0273
				Feed (ipm)	50.0	50.0	50.0	50.0	50.0	50.0	50.0
		≤ 260 Bhn or ≤ 26 HRc	335	RPM	10238	6825	5119	3413	2559	2048	1706
			(268-402)	Fr	0.0045	0.0068	0.0091	0.0136	0.0182	0.0227	0.0273
				Feed (ipm)	46.5	46.5	46.5	46.5	46.5	46.5	46.5

continued on next page

Series 140 5D Fractional	Hardness	Vc (sfm)	DC • in								
			1/8	3/16	1/4	3/8	1/2	5/8	3/4		
N ALUMINUM ALLOYS 2017, 2024, 356, 6061, 7075	≤ 80 Bhn or ≤ 47 HRb	770	RPM	23531	15687	11766	7844	5883	4706	3922	
		(616-924)	Fr	0.0049	0.0073	0.0098	0.0147	0.0195	0.0244	0.0293	
			Feed (ipm)	115.0	115.0	115.0	115.0	115.0	115.0	115.0	
	≤ 150 Bhn or ≤ 7 HRc	660	RPM	20170	13446	10085	6723	5042	4034	3362	
		(528-792)	Fr	0.0050	0.0074	0.0099	0.0149	0.0198	0.0248	0.0297	
			Feed (ipm)	100.0	100.0	100.0	100.0	100.0	100.0	100.0	
	COPPER ALLOYS Alum Bronze, C110, Muntz Brass	≤ 140 Bhn or ≤ 3 HRc	550	RPM	16808	11205	8404	5603	4202	3362	2801
			(440-660)	Fr	0.0020	0.0030	0.0040	0.0060	0.0080	0.0100	0.0120
				Feed (ipm)	33.5	33.5	33.5	33.5	33.5	33.5	33.5
		≤ 200 Bhn or ≤ 23 HRc	440	RPM	13446	8964	6723	4482	3362	2689	2241
			(352-528)	Fr	0.0020	0.0030	0.0040	0.0060	0.0080	0.0100	0.0120
				Feed (ipm)	27.0	27.0	27.0	27.0	27.0	27.0	27.0
S SUPER ALLOYS (NICKEL, COBALT, IRON BASE) Inconel 601, 617, 625, Incoloy, Monel 400, Rene, Waspaloy	≤ 300 Bhn or ≤ 32 HRc	95	RPM	2903	1935	1452	968	726	581	484	
		(76-114)	Fr	0.0008	0.0012	0.0016	0.0024	0.0032	0.0040	0.0048	
			Feed (ipm)	2.3	2.3	2.3	2.3	2.3	2.3	2.3	
	≤ 400 Bhn or ≤ 43 HRc	50	RPM	1528	1019	764	509	382	306	255	
		(40-60)	Fr	0.0007	0.0010	0.0013	0.0020	0.0026	0.0033	0.0039	
			Feed (ipm)	1.0	1.0	1.0	1.0	1.0	1.0	1.0	
	TITANIUM ALLOYS Pure Titanium, Ti6Al4V, Ti6Al2Sn4Zr2Mo, Ti4Al4Mo2Sn0.5Si, Ti-6Al4V	≤ 275 Bhn or ≤ 28 HRc	215	RPM	6570	4380	3285	2190	1643	1314	1095
			(172-258)	Fr	0.0018	0.0026	0.0035	0.0053	0.0070	0.0088	0.0105
				Feed (ipm)	11.5	11.5	11.5	11.5	11.5	11.5	11.5
		≤ 350 Bhn or ≤ 38 HRc	160	RPM	4890	3260	2445	1630	1222	978	815
			(128-192)	Fr	0.0016	0.0024	0.0032	0.0048	0.0064	0.0080	0.0096
				Feed (ipm)	7.8	7.8	7.8	7.8	7.8	7.8	7.8
≤ 440 Bhn or ≤ 47 HRc	85	RPM	2598	1732	1299	866	649	520	433		
	(68-102)	Fr	0.0012	0.0018	0.0024	0.0036	0.0048	0.0060	0.0072		
		Feed (ipm)	3.1	3.1	3.1	3.1	3.1	3.1	3.1		
H TOOL STEELS A2, D2, H13, L2, M2, P20, S7, T15, W2	≤ 200 Bhn or ≤ 13 HRc	145	RPM	4431	2954	2216	1477	1108	886	739	
		(116-174)	Fr	0.0026	0.0039	0.0052	0.0078	0.0104	0.0130	0.0156	
			Feed (ipm)	11.5	11.5	11.5	11.5	11.5	11.5	11.5	
	≤ 375 Bhn or ≤ 40 HRc	95	RPM	2903	1935	1452	968	726	581	484	
		(76-114)	Fr	0.0012	0.0018	0.0024	0.0036	0.0048	0.0060	0.0072	
			Feed (ipm)	3.5	3.5	3.5	3.5	3.5	3.5	3.5	
	≤ 475 Bhn or ≤ 50 HRc	85	RPM	2598	1732	1299	866	649	520	433	
		(68-102)	Fr	0.0008	0.0012	0.0015	0.0023	0.0031	0.0038	0.0046	
			Feed (ipm)	2.0	2.0	2.0	2.0	2.0	2.0	2.0	

Bhn (Brinell) HRc (Rockwell C) HRb (Rockwell B)
 rpm = Vc x 3.82 / DC
 ipm = Fr x rpm
 reduce speed and feed for materials harder than listed
 refer to the SGS Tool Wizard® for complete technical information (www.kyocera-sgstool.com)

Series 140M 5D Metric	Hardness	Vc (m/min)	DC • mm								
			3	6	8	10	12	14	16		
P CARBON STEELS 1018, 1040, 1080, 1090, 10L50, 1140, 1212, 12L15, 1525, 1536	≤ 175 Bhn or ≤ 7 HRc	130	RPM	13733	6867	5150	4120	3433	2943	2575	
		(104-155)	Fr	0.095	0.189	0.252	0.316	0.379	0.442	0.505	
			Feed (mm/min)	1300	1300	1300	1300	1300	1300	1300	
	≤ 275 Bhn or ≤ 28 HRc	116	RPM	12279	6140	4605	3684	3070	2631	2302	
		(93-139)	Fr	0.086	0.171	0.228	0.285	0.342	0.399	0.456	
			Feed (mm/min)	1050	1050	1050	1050	1050	1050	1050	
	≤ 425 Bhn or ≤ 45 HRc	67	RPM	7109	3555	2666	2133	1777	1523	1333	
		(54-80)	Fr	0.071	0.142	0.189	0.237	0.284	0.332	0.379	
			Feed (mm/min)	505	505	505	505	505	505	505	
	ALLOY STEELS 4140, 4150, 4320, 5120, 5150, 8630, 86L20, 50100	≤ 275 Bhn or ≤ 28 HRc	101	RPM	10664	5332	3999	3199	2666	2285	1999
			(80-121)	Fr	0.071	0.143	0.190	0.238	0.285	0.333	0.380
				Feed (mm/min)	760	760	760	760	760	760	760
≤ 375 Bhn or ≤ 40 HRc		61	RPM	6463	3231	2424	1939	1616	1385	1212	
		(49-73)	Fr	0.062	0.124	0.165	0.206	0.248	0.289	0.330	
			Feed (mm/min)	400	400	400	400	400	400	400	
≤ 450 Bhn or ≤ 48 HRc		43	RPM	4524	2262	1696	1357	1131	969	848	
		(34-51)	Fr	0.043	0.086	0.115	0.144	0.172	0.201	0.230	
			Feed (mm/min)	195	195	195	195	195	195	195	
M STAINLESS STEELS (FREE MACHINING) 303, 416, 420F, 430F, 440F		≤ 185 Bhn or ≤ 9 HRc	93	RPM	9856	4928	3696	2957	2464	2112	1848
			(74-112)	Fr	0.061	0.123	0.164	0.205	0.246	0.286	0.327
				Feed (mm/min)	605	605	605	605	605	605	605
	≤ 275 Bhn or ≤ 28 HRc	59	RPM	6301	3151	2363	1890	1575	1350	1181	
		(48-71)	Fr	0.048	0.095	0.127	0.159	0.190	0.222	0.254	
			Feed (mm/min)	300	300	300	300	300	300	300	
	≤ 275 Bhn or ≤ 28 HRc	46	RPM	4847	2424	1818	1454	1212	1039	909	
		(37-55)	Fr	0.047	0.095	0.127	0.158	0.190	0.221	0.253	
			Feed (mm/min)	230	230	230	230	230	230	230	
	≤ 375 Bhn or ≤ 40 HRc	34	RPM	3555	1777	1333	1066	889	762	666	
		(27-40)	Fr	0.042	0.084	0.113	0.141	0.169	0.197	0.225	
			Feed (mm/min)	150	150	150	150	150	150	150	
K CAST IRONS Gray, Malleable, Ductile	≤ 220 Bhn or ≤ 19 HRc	110	RPM	11633	5816	4362	3490	2908	2493	2181	
		(88-132)	Fr	0.109	0.218	0.291	0.364	0.437	0.509	0.582	
			Feed (mm/min)	1270	1270	1270	1270	1270	1270	1270	
	≤ 260 Bhn or ≤ 26 HRc	102	RPM	10825	5413	4059	3248	2706	2320	2030	
		(82-123)	Fr	0.109	0.218	0.291	0.363	0.436	0.509	0.581	
			Feed (mm/min)	1180	1180	1180	1180	1180	1180	1180	
	N ALUMINUM ALLOYS 2017, 2024, 356, 6061, 7075	≤ 80 Bhn or ≤ 47 HRb	235	RPM	24882	12441	9331	7465	6220	5332	4665
			(188-282)	Fr	0.118	0.237	0.316	0.395	0.473	0.552	0.631
				Feed (mm/min)	2945	2945	2945	2945	2945	2945	2945
		≤ 150 Bhn or ≤ 7 HRc	201	RPM	21327	10664	7998	6398	5332	4570	3999
			(161-241)	Fr	0.119	0.238	0.318	0.397	0.476	0.556	0.635
				Feed (mm/min)	2540	2540	2540	2540	2540	2540	2540
≤ 140 Bhn or ≤ 3 HRc		168	RPM	17773	8886	6665	5332	4443	3808	3332	
		(134-201)	Fr	0.048	0.096	0.128	0.159	0.191	0.223	0.255	
			Feed (mm/min)	850	850	850	850	850	850	850	
COPPER ALLOYS Alum Bronze, C110, Muntz Brass		≤ 200 Bhn or ≤ 23 HRc	134	RPM	14218	7109	5332	4265	3555	3047	2666
			(107-161)	Fr	0.048	0.096	0.128	0.161	0.193	0.225	0.257
				Feed (mm/min)	685	685	685	685	685	685	685

continued on next page

Series	140M 5D	Metric	Hardness	Vc (m/min)	DC • mm						
					3	6	8	10	12	14	16
S	SUPER ALLOYS (NICKEL, COBALT, IRON BASE) Inconel 601, 617, 625, Incoloy, Monel 400, Rene, Waspaloy	≤ 300 Bhn or ≤ 32 HRc	29	RPM	3070	1535	1151	921	767	658	576
			(23-35)	Fr	0.020	0.039	0.052	0.065	0.078	0.091	0.104
				Feed (mm/min)	60	60	60	60	60	60	60
		≤ 400 Bhn or ≤ 43 HRc	15	RPM	1616	808	606	485	404	346	303
			(12-18)	Fr	0.015	0.031	0.041	0.052	0.062	0.072	0.083
				Feed (mm/min)	25	25	25	25	25	25	25
	TITANIUM ALLOYS Pure Titanium, Ti6Al4V, Ti6Al2Sn4Zr2Mo, Ti4Al4Mo2Sn0.5Si, Ti-6Al4V	≤ 275 Bhn or ≤ 28 HRc	66	RPM	6947	3474	2605	2084	1737	1489	1303
			(52-79)	Fr	0.040	0.079	0.106	0.132	0.158	0.185	0.211
				Feed (mm/min)	275	275	275	275	275	275	275
		≤ 350 Bhn or ≤ 38 HRc	49	RPM	5170	2585	1939	1551	1293	1108	969
			(39-59)	Fr	0.039	0.077	0.103	0.129	0.155	0.181	0.206
				Feed (mm/min)	200	200	200	200	200	200	200
≤ 440 Bhn or ≤ 47 HRc	26	RPM	2747	1373	1030	824	687	589	515		
	(21-31)	Fr	0.029	0.058	0.078	0.097	0.117	0.136	0.155		
		Feed (mm/min)	80	80	80	80	80	80	80		
H	TOOL STEELS A2, D2, H13, L2, M2, P20, S7, T15, W2	≤ 200 Bhn or ≤ 13 HRc	44	RPM	4686	2343	1757	1406	1171	1004	879
			(35-53)	Fr	0.061	0.122	0.162	0.203	0.243	0.284	0.324
				Feed (mm/min)	285	285	285	285	285	285	285
	≤ 375 Bhn or ≤ 40 HRc	29	RPM	3070	1535	1151	921	767	658	576	
		(23-35)	Fr	0.029	0.059	0.078	0.098	0.117	0.137	0.156	
			Feed (mm/min)	90	90	90	90	90	90	90	
	≤ 475 Bhn or ≤ 50 HRc	26	RPM	2747	1373	1030	824	687	589	515	
		(21-31)	Fr	0.018	0.036	0.049	0.061	0.073	0.085	0.097	
			Feed (mm/min)	50	50	50	50	50	50	50	

Bhn (Brinell) HRc (Rockwell C) HRb (Rockwell B)
rpm = (Vc x 1000) / (DC x 3.14)
mm/min = Fr x rpm
reduce speed and feed for materials harder than listed
refer to the SGS Tool Wizard® for complete technical information (www.kyocera-sgstool.com)



8xD

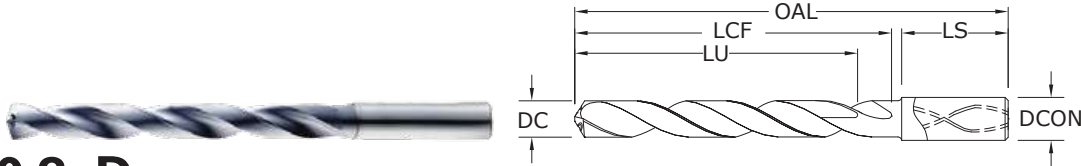

140 8xD

FRACTIONAL & METRIC SERIES

- Coolant through design promotes controlled and consistent operating temperatures improving coolant flow to the cut while maintaining strength
- Split point geometry for improved drill penetration and accuracy
- Controlled edge honing for longevity
- Negative corner position strengthens and protects
- Recommended for materials ≤ 60 HRc (≤ 654 Bhn)

inch & mm									EDP NO.
CUTTING DIAMETER DC	DECIMAL EQUIV.	METRIC EQUIV.	TAP SIZE REFERENCE ONLY	SHANK DIAMETER DCON	OVERALL LENGTH OAL	FLUTE LENGTH LCF	CLEARED LENGTH LU	SHANK LENGTH LS	Ti-NAMITE-A (AITiN)
3,0 mm	0.1181			6,0	72,0	34,0	29,0	36,0	63575
3,1 mm	0.1220			6,0	72,0	34,0	29,0	36,0	63576
1/8	0.1250	3.18		6,0	72,0	34,0	29,0	36,0	51801
3,2 mm	0.1260		M3,5 X 0,35	6,0	72,0	34,0	29,0	36,0	63577
3,3 mm	0.1299		M4 X 0,7	6,0	72,0	34,0	29,0	36,0	63578
3,4 mm	0.1339			6,0	72,0	34,0	29,0	36,0	63579
#29	0.1360	3.45	8-32,8-36	6,0	72,0	34,0	29,0	36,0	51802
3,5 mm	0.1378		M4 X 0,5	6,0	72,0	34,0	29,0	36,0	63580
9/64	0.1406	3.57		6,0	72,0	34,0	29,0	36,0	51803
3,6 mm	0.1417		M4 X 0,35	6,0	72,0	34,0	29,0	36,0	63581
3,7 mm	0.1457		M4,5 X 0,75	6,0	72,0	34,0	29,0	36,0	63582
3,8 mm	0.1496		10-24	6,0	81,0	43,0	36,0	36,0	63583
3,9 mm	0.1535			6,0	81,0	43,0	36,0	36,0	63584
5/32	0.1562	3.97		6,0	81,0	43,0	36,0	36,0	51804
4,0 mm	0.1575		M4,5 X 0,5	6,0	81,0	43,0	36,0	36,0	63585
#21	0.1590	4.04	10-32	6,0	81,0	43,0	36,0	36,0	51805
4,1 mm	0.1614			6,0	81,0	43,0	36,0	36,0	63586
4,2 mm	0.1654		M5 / M5 X 0,75	6,0	81,0	43,0	36,0	36,0	63587
4,3 mm	0.1693			6,0	81,0	43,0	36,0	36,0	63588
11/64	0.1719	4.37		6,0	81,0	43,0	36,0	36,0	51806
4,4 mm	0.1732		12-24	6,0	81,0	43,0	36,0	36,0	63589
4,5 mm	0.1772		M5 X 0,5	6,0	81,0	43,0	36,0	36,0	63590
4,6 mm	0.1811		12-28	6,0	81,0	43,0	36,0	36,0	63591
4,7 mm	0.1850		12-32	6,0	81,0	43,0	36,0	36,0	63592
3/16	0.1875	4.76		6,0	95,0	57,0	48,0	36,0	51807
4,8 mm	0.1890		7/32-32	6,0	95,0	57,0	48,0	36,0	63593
4,9 mm	0.1929			6,0	95,0	57,0	48,0	36,0	63594
5,0 mm	0.1969		M6 X 1	6,0	95,0	57,0	48,0	36,0	63595
5,1 mm	0.2008		1/4-20	6,0	95,0	57,0	48,0	36,0	63596
13/64	0.2031	5.16		6,0	95,0	57,0	48,0	36,0	51808
5,2 mm	0.2047		M6 X 0,75	6,0	95,0	57,0	48,0	36,0	63597
5,3 mm	0.2087			6,0	95,0	57,0	48,0	36,0	63598
5,4 mm	0.2126			6,0	95,0	57,0	48,0	36,0	63599
5,5 mm	0.2165		M6 X 0,5	6,0	95,0	57,0	48,0	36,0	63600

continued on next page

TOLERANCES (inch)

≤.1181 DIAMETER

DC = +.00008/+0.00047

DCON = h₆

>.1181-.2362 DIAMETER

DC = +.00016/+0.00063

DCON = h₆

>.2362-.3937 DIAMETER

DC = +.00024/+0.00083

DCON = h₆

>.3937-.7087 DIAMETER

DC = +.00028/+0.00098

DCON = h₆

>.7087-1.1811 DIAMETER

DC = +.00031/+0.00114

DCON = h₆

TOLERANCES (mm)

≤3 DIAMETER

DC = +0,002/+0,012

DCON = h₆

>3-6 DIAMETER

DC = +0,004/+0,016

DCON = h₆

>6-10 DIAMETER

DC = +0,006/+0,021

DCON = h₆

>10-18 DIAMETER

DC = +0,007/+0,025

DCON = h₆

STEELS

STAINLESS STEELS

CAST IRON

HIGH TEMP ALLOYS

TITANIUM

NON-FERROUS

HARDENED STEELS

For patent information visit www.ksptpatents.com

140 8xD

FRACTIONAL & METRIC SERIES

CUTTING DIAMETER DC	DECIMAL EQUIV.	METRIC EQUIV.	inch & mm						EDP NO.	
			TAP SIZE REFERENCE ONLY	SHANK DIAMETER DCON	OVERALL LENGTH OAL	FLUTE LENGTH LCF	CLEARED LENGTH LU	SHANK LENGTH LS	Ti-NAMITE-A (AITIN)	
7/32	0.2188	5.56	1/4-32	6,0	95,0	57,0	48,0	36,0	51809	
5,6 mm	0.2205			6,0	95,0	57,0	48,0	36,0	63601	
5,7 mm	0.2244			6,0	95,0	57,0	48,0	36,0	63602	
5,8 mm	0.2283			6,0	95,0	57,0	48,0	36,0	63603	
5,9 mm	0.2323			6,0	95,0	57,0	48,0	36,0	63604	
15/64	0.2344	5.95		6,0	95,0	57,0	48,0	36,0	51810	
6,0 mm	0.2362		M7 X 1	6,0	95,0	57,0	48,0	36,0	63605	
6,1 mm	0.2402			8,0	114,0	76,0	64,0	36,0	63606	
6,2 mm	0.2441		M7 X 0,75	8,0	114,0	76,0	64,0	36,0	63607	
6,3 mm	0.2480			8,0	114,0	76,0	64,0	36,0	63608	
1/4	0.2500	6.35		8,0	114,0	76,0	64,0	36,0	51811	
6,4 mm	0.2520			8,0	114,0	76,0	64,0	36,0	63609	
6,5 mm	0.2559			8,0	114,0	76,0	64,0	36,0	63610	
F	0.2570	6.53	5/16-18	8,0	114,0	76,0	64,0	36,0	51812	
6,6 mm	0.2598			8,0	114,0	76,0	64,0	36,0	63611	
6,7 mm	0.2638			8,0	114,0	76,0	64,0	36,0	63612	
17/64	0.2656	6.75	5/16-20	8,0	114,0	76,0	64,0	36,0	51813	
6,8 mm	0.2677		M8 X 1,25	8,0	114,0	76,0	64,0	36,0	63613	
6,9 mm	0.2717			8,0	114,0	76,0	64,0	36,0	63614	
7,0 mm	0.2756		M8 X 1	8,0	114,0	76,0	64,0	36,0	63615	
7,1 mm	0.2795			8,0	114,0	76,0	64,0	36,0	63616	
9/32	0.2812	7.14	5/16-32	8,0	114,0	76,0	64,0	36,0	51814	
7,2 mm	0.2835		M8 X 0,75	8,0	114,0	76,0	64,0	36,0	63617	
7,3 mm	0.2874			8,0	114,0	76,0	64,0	36,0	63618	
7,4 mm	0.2913			8,0	114,0	76,0	64,0	36,0	63619	
7,5 mm	0.2953		M8 X 0,5	8,0	114,0	76,0	64,0	36,0	63620	
19/64	0.2969	7.54		8,0	114,0	76,0	64,0	36,0	51815	
7,6 mm	0.2992			8,0	114,0	76,0	64,0	36,0	63621	
7,7 mm	0.3031			8,0	114,0	76,0	64,0	36,0	63622	
7,8 mm	0.3071		M9 X 1,25	8,0	114,0	76,0	64,0	36,0	63623	
7,9 mm	0.3110			8,0	114,0	76,0	64,0	36,0	63624	
5/16	0.3125	7.94	3/8-16	8,0	114,0	76,0	64,0	36,0	51816	
8,0 mm	0.3150		M9 X 1	8,0	114,0	76,0	64,0	36,0	63625	
8,1 mm	0.3189			10,0	142,0	95,0	80,0	40,0	63626	
8,2 mm	0.3228			10,0	142,0	95,0	80,0	40,0	63627	
8,3 mm	0.3268			10,0	142,0	95,0	80,0	40,0	63628	
21/64	0.3281	8.33	3/8-20	10,0	142,0	95,0	80,0	40,0	51817	
8,4 mm	0.3307			10,0	142,0	95,0	80,0	40,0	63629	
Q	0.3320	8.43	3/8-24	10,0	142,0	95,0	80,0	40,0	51818	
8,5 mm	0.3346		M10 X 1,5	10,0	142,0	95,0	80,0	40,0	63630	
8,6 mm	0.3386			10,0	142,0	95,0	80,0	40,0	63631	
8,7 mm	0.3425			10,0	142,0	95,0	80,0	40,0	63632	

continued on next page

CONTINUED



8xD

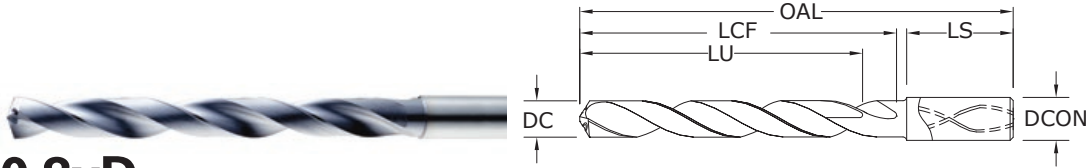

140 8xD

FRACTIONAL & METRIC SERIES

- Coolant through design promotes controlled and consistent operating temperatures improving coolant flow to the cut while maintaining strength
- Split point geometry for improved drill penetration and accuracy
- Controlled edge honing for longevity
- Negative corner position strengthens and protects
- Recommended for materials ≤ 60 HRc (≤ 654 Bhn)

inch & mm										EDP NO.
CUTTING DIAMETER DC	DECIMAL EQUIV.	METRIC EQUIV.	TAP SIZE REFERENCE ONLY	SHANK DIAMETER DCON	OVERALL LENGTH OAL	FLUTE LENGTH LCF	CLEARED LENGTH LU	SHANK LENGTH LS	Ti-NAMITE-A (AITiN)	
11/32	0.3438	8.73	3/8-32	10,0	142,0	95,0	80,0	40,0	51819	
8,8 mm	0.3465		M10 X 1,25	10,0	142,0	95,0	80,0	40,0	63633	
8,9 mm	0.3504			10,0	142,0	95,0	80,0	40,0	63634	
9,0 mm	0.3543		M10 X 1	10,0	142,0	95,0	80,0	40,0	63635	
9,1 mm	0.3583			10,0	142,0	95,0	80,0	40,0	63636	
23/64	0.3594	9.13		10,0	142,0	95,0	80,0	40,0	51820	
9,2 mm	0.3622		M10 X 0,75	10,0	142,0	95,0	80,0	40,0	63637	
9,3 mm	0.3661			10,0	142,0	95,0	80,0	40,0	63638	
U	0.3680	9.35	7/16-14	10,0	142,0	95,0	80,0	40,0	51821	
9,4 mm	0.3701			10,0	142,0	95,0	80,0	40,0	63639	
9,5 mm	0.3740		M11 / M10 X 0,5	10,0	142,0	95,0	80,0	40,0	63640	
3/8	0.3750	9.53		10,0	142,0	95,0	80,0	40,0	51822	
9,6 mm	0.3780			10,0	142,0	95,0	80,0	40,0	63641	
9,7 mm	0.3819			10,0	142,0	95,0	80,0	40,0	63642	
9,8 mm	0.3858			10,0	142,0	95,0	80,0	40,0	63643	
9,9 mm	0.3898			10,0	142,0	95,0	80,0	40,0	63644	
25/64	0.3906	9.92	7/16-20	10,0	142,0	95,0	80,0	40,0	51823	
10,0 mm	0.3937			10,0	142,0	95,0	80,0	40,0	63645	
10,1 mm	0.3976			12,0	162,0	114,0	96,0	45,0	63646	
10,2 mm	0.4016		M12 X 1,75	12,0	162,0	114,0	96,0	45,0	63647	
10,3 mm	0.4055			12,0	162,0	114,0	96,0	45,0	63648	
13/32	0.4062	10.32		12,0	162,0	114,0	96,0	45,0	51824	
10,4 mm	0.4094			12,0	162,0	114,0	96,0	45,0	63649	
10,5 mm	0.4134		M12 X 1,5	12,0	162,0	114,0	96,0	45,0	63650	
10,6 mm	0.4173			12,0	162,0	114,0	96,0	45,0	63651	
10,7 mm	0.4213			12,0	162,0	114,0	96,0	45,0	63652	
27/64	0.4219	10.72	1/2-13	12,0	162,0	114,0	96,0	45,0	51825	
10,8 mm	0.4252		M12 X 1,25	12,0	162,0	114,0	96,0	45,0	63653	
10,9 mm	0.4291			12,0	162,0	114,0	96,0	45,0	63654	
11,0 mm	0.4331		M12 X 1	12,0	162,0	114,0	96,0	45,0	63655	
11,1 mm	0.4370			12,0	162,0	114,0	96,0	45,0	63656	
7/16	0.4375	11.11	1/4-18NPT	12,0	162,0	114,0	96,0	45,0	51826	

continued on next page

TOLERANCES (inch)

- ≤.1181 DIAMETER
DC = +.00008/+0.00047
DCON = h₆
- >.1181-.2362 DIAMETER
DC = +.00016/+0.00063
DCON = h₆
- >.2362-.3937 DIAMETER
DC = +.00024/+0.00083
DCON = h₆
- >.3937-.7087 DIAMETER
DC = +.00028/+0.00098
DCON = h₆
- >.7087-1.1811 DIAMETER
DC = +.00031/+0.00114
DCON = h₆

TOLERANCES (mm)

- ≤3 DIAMETER
DC = +0,002/+0,012
DCON = h₆
- >3-6 DIAMETER
DC = +0,004/+0,016
DCON = h₆
- >6-10 DIAMETER
DC = +0,006/+0,021
DCON = h₆
- >10-18 DIAMETER
DC = +0,007/+0,025
DCON = h₆

- STEELS
- STAINLESS STEELS
- CAST IRON
- HIGH TEMP ALLOYS
- TITANIUM
- NON-FERROUS
- HARDENED STEELS

For patent information visit www.ksptpatents.com

140 8xD

FRACTIONAL & METRIC SERIES

CUTTING DIAMETER DC	DECIMAL EQUIV.	METRIC EQUIV.	inch & mm						EDP NO.
			TAP SIZE REFERENCE ONLY	SHANK DIAMETER DCON	OVERALL LENGTH OAL	FLUTE LENGTH LCF	CLEARED LENGTH LU	SHANK LENGTH LS	Ti-NAMITE-A (AITIN)
11,2 mm	0.4409			12,0	162,0	114,0	96,0	45,0	63657
11,3 mm	0.4449			12,0	162,0	114,0	96,0	45,0	63658
11,4 mm	0.4488			12,0	162,0	114,0	96,0	45,0	63659
11,5 mm	0.4528		M12 X 0,5	12,0	162,0	114,0	96,0	45,0	63660
11,6 mm	0.4567			12,0	162,0	114,0	96,0	45,0	63661
11,7 mm	0.4606			12,0	162,0	114,0	96,0	45,0	63662
11,8 mm	0.4646			12,0	162,0	114,0	96,0	45,0	63663
11,9 mm	0.4685			12,0	162,0	114,0	96,0	45,0	63664
15/32	0.4688	11.91	1/2-28	12,0	162,0	114,0	96,0	45,0	51827
12,0 mm	0.4724		M14 X 2	12,0	162,0	114,0	96,0	45,0	63665
31/64	0.4844	12.30	9/16-12	14,0	178,0	133,0	112,0	45,0	51828
12,5 mm	0.4921		M14 X 1,5	14,0	178,0	133,0	112,0	45,0	63666
1/2	0.5000	12.70		14,0	178,0	133,0	112,0	45,0	51829
12,8 mm	0.5039		M14 X 1,25	14,0	178,0	133,0	112,0	45,0	63667
13,0 mm	0.5118		M14 X 1	14,0	178,0	133,0	112,0	45,0	63668
33/64	0.5156	13.10	9/16-18	14,0	178,0	133,0	112,0	45,0	51830
13,5 mm	0.5315		5/8-11	14,0	178,0	133,0	112,0	45,0	63669
13,8 mm	0.5433			14,0	178,0	133,0	112,0	45,0	63670
14,0 mm	0.5512		M16 X 2	14,0	178,0	133,0	112,0	45,0	63671
9/16	0.5625	14.29		16,0	203,0	152,0	128,0	48,0	51831
14,5 mm	0.5709		M16 X 1,5	16,0	203,0	152,0	128,0	48,0	63672
37/64	0.5781	14.68	5/8-18	16,0	203,0	152,0	128,0	48,0	51832
14,8 mm	0.5827			16,0	203,0	152,0	128,0	48,0	63673
15,0 mm	0.5906		M16 X 1	16,0	203,0	152,0	128,0	48,0	63674
15,5 mm	0.6102		M18 X 2,5	16,0	203,0	152,0	128,0	48,0	63675
15,8 mm	0.6220			16,0	203,0	152,0	128,0	48,0	63676
5/8	0.6250	15.88	11/16-16	16,0	203,0	152,0	128,0	48,0	51833
16,0 mm	0.6299			16,0	203,0	152,0	128,0	48,0	63677
21/32	0.6562	16.67	3/4-10	18,0	222,0	171,0	144,0	48,0	51834
11/16	0.6875	17.46	3/4-16	18,0	222,0	171,0	144,0	48,0	51835
3/4	0.7500	19.05	13/16-16	20,0	243,0	190,0	160,0	50,0	51836

CONTINUED

Series 140 8D Fractional	Hardness	Vc (sfm)		DC • in							
				1/8	3/16	1/4	3/8	1/2	5/8	3/4	
P CARBON STEELS 1018, 1040, 1080, 1090, 10L50, 1140, 1212, 12L15, 1525, 1536	≤ 175 Bhn or ≤ 7 HRc	405 (324-486)	RPM	12377	8251	6188	4126	3094	2475	2063	
			Fr	0.0036	0.0053	0.0071	0.0107	0.0142	0.0178	0.0213	
			Feed (ipm)	44.0	44.0	44.0	44.0	44.0	44.0	44.0	
	≤ 275 Bhn or ≤ 28 HRc	370 (296-444)	RPM	11307	7538	5654	3769	2827	2261	1885	
			Fr	0.0030	0.0045	0.0060	0.0090	0.0120	0.0150	0.0180	
			Feed (ipm)	34.0	34.0	34.0	34.0	34.0	34.0	34.0	
	≤ 425 Bhn or ≤ 45 HRc	210 (168-252)	RPM	6418	4278	3209	2139	1604	1284	1070	
			Fr	0.0026	0.0039	0.0051	0.0077	0.0103	0.0129	0.0154	
			Feed (ipm)	16.5	16.5	16.5	16.5	16.5	16.5	16.5	
	M ALLOY STEELS 4140, 4150, 4320, 5120, 5150, 8630, 86L20, 50100	≤ 275 Bhn or ≤ 28 HRc	320 (256-384)	RPM	9779	6519	4890	3260	2445	1956	1630
				Fr	0.0026	0.0038	0.0051	0.0077	0.0102	0.0128	0.0153
				Feed (ipm)	25.0	25.0	25.0	25.0	25.0	25.0	25.0
≤ 375 Bhn or ≤ 40 HRc		190 (152-228)	RPM	5806	3871	2903	1935	1452	1161	968	
			Fr	0.0020	0.0030	0.0040	0.0059	0.0079	0.0099	0.0119	
			Feed (ipm)	11.5	11.5	11.5	11.5	11.5	11.5	11.5	
≤ 450 Bhn or ≤ 48 HRc		135 (108-162)	RPM	4126	2750	2063	1375	1031	825	688	
			Fr	0.0016	0.0024	0.0032	0.0047	0.0063	0.0079	0.0095	
			Feed (ipm)	6.5	6.5	6.5	6.5	6.5	6.5	6.5	
M STAINLESS STEELS (FREE MACHINING) 303, 416, 420F, 430F, 440F		≤ 185 Bhn or ≤ 9 HRc	290 (232-348)	RPM	8862	5908	4431	2954	2216	1772	1477
				Fr	0.0020	0.0030	0.0039	0.0059	0.0079	0.0099	0.0118
				Feed (ipm)	17.5	17.5	17.5	17.5	17.5	17.5	17.5
	≤ 275 Bhn or ≤ 28 HRc	180 (144-216)	RPM	5501	3667	2750	1834	1375	1100	917	
			Fr	0.0018	0.0027	0.0036	0.0055	0.0073	0.0091	0.0109	
			Feed (ipm)	10.0	10.0	10.0	10.0	10.0	10.0	10.0	
	≤ 275 Bhn or ≤ 28 HRc	130 (104-156)	RPM	3973	2649	1986	1324	993	795	662	
			Fr	0.0018	0.0026	0.0035	0.0053	0.0070	0.0088	0.0106	
			Feed (ipm)	7.0	7.0	7.0	7.0	7.0	7.0	7.0	
	≤ 375 Bhn or ≤ 40 HRc	95 (76-114)	RPM	2903	1935	1452	968	726	581	484	
			Fr	0.0016	0.0023	0.0031	0.0047	0.0062	0.0078	0.0093	
			Feed (ipm)	4.5	4.5	4.5	4.5	4.5	4.5	4.5	
K CAST IRONS Gray, Malleable, Ductile	≤ 220 Bhn or ≤ 19 HRc	350 (280-420)	RPM	10696	7131	5348	3565	2674	2139	1783	
			Fr	0.0037	0.0056	0.0075	0.0112	0.0150	0.0187	0.0224	
			Feed (ipm)	40.0	40.0	40.0	40.0	40.0	40.0	40.0	
	≤ 260 Bhn or ≤ 26 HRc	310 (248-372)	RPM	9474	6316	4737	3158	2368	1895	1579	
			Fr	0.0039	0.0059	0.0078	0.0117	0.0156	0.0195	0.0234	
			Feed (ipm)	37.0	37.0	37.0	37.0	37.0	37.0	37.0	

continued on next page

Series 140 8D Fractional	Hardness	Vc (sfm)		DC • in							
				1/8	3/16	1/4	3/8	1/2	5/8	3/4	
N ALUMINUM ALLOYS 2017, 2024, 356, 6061, 7075	≤ 80 Bhn or ≤ 47 HRb	730 (584-876)	RPM	22309	14873	11154	7436	5577	4462	3718	
			Fr	0.0045	0.0067	0.0090	0.0134	0.0179	0.0224	0.0269	
			Feed (ipm)	100.0	100.0	100.0	100.0	100.0	100.0	100.0	
	≤ 150 Bhn or ≤ 7 HRc	635 (508-762)	RPM	19406	12937	9703	6469	4851	3881	3234	
			Fr	0.0046	0.0070	0.0093	0.0139	0.0186	0.0232	0.0278	
			Feed (ipm)	90.0	90.0	90.0	90.0	90.0	90.0	90.0	
	COPPER ALLOYS Alum Bronze, C110, Muntz Brass	≤ 140 Bhn or ≤ 3 HRc	255 (204-306)	RPM	7793	5195	3896	2598	1948	1559	1299
				Fr	0.0018	0.0027	0.0036	0.0054	0.0072	0.0090	0.0108
				Feed (ipm)	14.0	14.0	14.0	14.0	14.0	14.0	14.0
		≤ 200 Bhn or ≤ 23 HRc	235 (188-282)	RPM	7182	4788	3591	2394	1795	1436	1197
				Fr	0.0018	0.0027	0.0036	0.0054	0.0072	0.0091	0.0109
				Feed (ipm)	13.0	13.0	13.0	13.0	13.0	13.0	13.0
S SUPER ALLOYS (NICKEL, COBALT, IRON BASE) Inconel 601, 617, 625, Incoloy, Monel 400, Rene, Waspaloy	≤ 300 Bhn or ≤ 32 HRc	65 (52-78)	RPM	1986	1324	993	662	497	397	331	
			Fr	0.0009	0.0013	0.0017	0.0026	0.0034	0.0043	0.0051	
			Feed (ipm)	1.7	1.7	1.7	1.7	1.7	1.7	1.7	
	≤ 400 Bhn or ≤ 43 HRc	35 (28-42)	RPM	1070	713	535	357	267	214	178	
			Fr	0.0006	0.0008	0.0011	0.0017	0.0022	0.0028	0.0034	
			Feed (ipm)	0.6	0.6	0.6	0.6	0.6	0.6	0.6	
	TITANIUM ALLOYS Pure Titanium, Ti6Al4V, Ti6Al2Sn4Zr2Mo, Ti4Al4Mo2Sn0.5Si, Ti-6Al4V	≤ 275 Bhn or ≤ 28 HRc	185 (148-222)	RPM	5654	3769	2827	1885	1413	1131	942
				Fr	0.0016	0.0024	0.0032	0.0048	0.0064	0.0080	0.0096
				Feed (ipm)	9.0	9.0	9.0	9.0	9.0	9.0	9.0
		≤ 350 Bhn or ≤ 38 HRc	140 (112-168)	RPM	4278	2852	2139	1426	1070	856	713
				Fr	0.0012	0.0018	0.0023	0.0035	0.0047	0.0058	0.0070
				Feed (ipm)	5.0	5.0	5.0	5.0	5.0	5.0	5.0
≤ 440 Bhn or ≤ 47 HRc	75 (60-90)	RPM	2292	1528	1146	764	573	458	382		
		Fr	0.0010	0.0015	0.0020	0.0030	0.0040	0.0050	0.0060		
		Feed (ipm)	2.3	2.3	2.3	2.3	2.3	2.3	2.3		
H TOOL STEELS A2, D2, H13, L2, M2, P20, S7, T15, W2	≤ 200 Bhn or ≤ 13 HRc	140 (112-168)	RPM	4278	2852	2139	1426	1070	856	713	
			Fr	0.0020	0.0030	0.0040	0.0060	0.0079	0.0099	0.0119	
			Feed (ipm)	8.5	8.5	8.5	8.5	8.5	8.5	8.5	
	≤ 375 Bhn or ≤ 40 HRc	90 (72-108)	RPM	2750	1834	1375	917	688	550	458	
			Fr	0.0011	0.0016	0.0022	0.0033	0.0044	0.0055	0.0065	
			Feed (ipm)	3.0	3.0	3.0	3.0	3.0	3.0	3.0	
	≤ 475 Bhn or ≤ 50 HRc	80 (64-96)	RPM	2445	1630	1222	815	611	489	407	
			Fr	0.0006	0.0009	0.0012	0.0018	0.0025	0.0031	0.0037	
			Feed (ipm)	1.5	1.5	1.5	1.5	1.5	1.5	1.5	

Bhn (Brinell) HRc (Rockwell C) HRb (Rockwell B)
 $rpm = Vc \times 3.82 / DC$
 $ipm = Fr \times rpm$
 reduce speed and feed for materials harder than listed
 refer to the SGS Tool Wizard® for complete technical information (www.kyocera-sgstool.com)

Series 140M 8D Metric	Hardness	Vc (m/min)	DC • mm								
			3	6	8	10	12	14	16		
P CARBON STEELS 1018, 1040, 1080, 1090, 10L50, 1140, 1212, 12L15, 1525, 1536	≤ 175 Bhn or ≤ 7 HRc	123	RPM	13087	6544	4908	3926	3272	2804	2454	
		(100-170)	Fr	0.085	0.171	0.228	0.285	0.342	0.399	0.455	
			Feed (mm/min)	1118	1118	1118	1118	1118	1118	1118	
	≤ 275 Bhn or ≤ 28 HRc	113	RPM	11956	5978	4484	3587	2989	2562	2242	
		(90-135)	Fr	0.072	0.144	0.193	0.241	0.289	0.337	0.385	
			Feed (mm/min)	864	864	864	864	864	864	864	
	≤ 425 Bhn or ≤ 45 HRc	64	RPM	6786	3393	2545	2036	1696	1454	1272	
		(51-77)	Fr	0.062	0.124	0.165	0.206	0.247	0.288	0.329	
			Feed (mm/min)	419	419	419	419	419	419	419	
	M ALLOY STEELS 4140, 4150, 4320, 5120, 5150, 8630, 86L20, 50100	≤ 275 Bhn or ≤ 28 HRc	98	RPM	10340	5170	3878	3102	2585	2216	1939
			(78-117)	Fr	0.061	0.123	0.164	0.205	0.246	0.287	0.328
				Feed (mm/min)	635	635	635	635	635	635	635
≤ 375 Bhn or ≤ 40 HRc		58	RPM	6140	3070	2302	1842	1535	1316	1151	
		(46-69)	Fr	0.048	0.095	0.127	0.159	0.190	0.222	0.254	
			Feed (mm/min)	292	292	292	292	292	292	292	
≤ 450 Bhn or ≤ 48 HRc		41	RPM	4362	2181	1636	1309	1091	935	818	
		(33-49)	Fr	0.038	0.076	0.101	0.126	0.151	0.177	0.202	
			Feed (mm/min)	165	165	165	165	165	165	165	
K STAINLESS STEELS (FREE MACHINING) 303, 416, 420F, 430F, 440F		≤ 185 Bhn or ≤ 9 HRc	88	RPM	9371	4686	3514	2811	2343	2008	1757
			(71-106)	Fr	0.047	0.095	0.126	0.158	0.190	0.221	0.253
				Feed (mm/min)	445	445	445	445	445	445	445
	≤ 275 Bhn or ≤ 28 HRc	55	RPM	5816	2908	2181	1745	1454	1246	1091	
		(44-66)	Fr	0.044	0.087	0.116	0.146	0.175	0.204	0.233	
			Feed (mm/min)	254	254	254	254	254	254	254	
K STAINLESS STEELS (DIFFICULT) 304, 316, 321, 13-8 PH, 15-5PH, 17-4 PH, Custom 450	≤ 275 Bhn or ≤ 28 HRc	40	RPM	4201	2100	1575	1260	1050	900	788	
		(32-48)	Fr	0.042	0.085	0.113	0.141	0.169	0.198	0.226	
			Feed (mm/min)	178	178	178	178	178	178	178	
	≤ 375 Bhn or ≤ 40 HRc	29	RPM	3070	1535	1151	921	767	658	576	
		(23-35)	Fr	0.037	0.074	0.099	0.124	0.149	0.174	0.199	
			Feed (mm/min)	114	114	114	114	114	114	114	
K CAST IRONS Gray, Malleable, Ductile	≤ 220 Bhn or ≤ 19 HRc	107	RPM	11310	5655	4241	3393	2827	2424	2121	
		(85-128)	Fr	0.090	0.180	0.240	0.299	0.359	0.419	0.479	
			Feed (mm/min)	1016	1016	1016	1016	1016	1016	1016	
	≤ 260 Bhn or ≤ 26 HRc	94	RPM	10017	5009	3756	3005	2504	2147	1878	
		(76-113)	Fr	0.094	0.188	0.250	0.313	0.375	0.438	0.500	
			Feed (mm/min)	940	940	940	940	940	940	940	

continued on next page

Series 140M 8D Metric	Hardness	Vc (m/min)	DC • mm								
			3	6	8	10	12	14	16		
N ALUMINUM ALLOYS 2017, 2024, 356, 6061, 7075	≤ 80 Bhn or ≤ 47 HRb	223	RPM	23589	11795	8846	7077	5897	5055	4423	
		(178-267)	Fr	0.108	0.215	0.287	0.359	0.431	0.502	0.574	
			Feed (mm/min)	2540	2540	2540	2540	2540	2540	2540	
	≤ 150 Bhn or ≤ 7 HRc	194	RPM	20519	10260	7695	6156	5130	4397	3847	
		(155-232)	Fr	0.111	0.223	0.297	0.371	0.446	0.520	0.594	
			Feed (mm/min)	2286	2286	2286	2286	2286	2286	2286	
	COPPER ALLOYS Alum Bronze, C110, Muntz Brass	≤ 140 Bhn or ≤ 3 HRc	78	RPM	8240	4120	3090	2472	2060	1766	1545
			(62-93)	Fr	0.043	0.086	0.115	0.144	0.173	0.201	0.230
				Feed (mm/min)	356	356	356	356	356	356	356
		≤ 200 Bhn or ≤ 23 HRc	72	RPM	7594	3797	2848	2278	1898	1627	1424
			(57-86)	Fr	0.043	0.087	0.116	0.145	0.174	0.203	0.232
				Feed (mm/min)	330	330	330	330	330	330	330
S SUPER ALLOYS (NICKEL, COBALT, IRON BASE) Inconel 601, 617, 625, Incoloy, Monel 400, Rene, Waspaloy	≤ 300 Bhn or ≤ 32 HRc	20	RPM	2100	1050	788	630	525	450	394	
		(16-24)	Fr	0.021	0.041	0.055	0.069	0.082	0.096	0.110	
			Feed (mm/min)	43	43	43	43	43	43	43	
	≤ 400 Bhn or ≤ 43 HRc	11	RPM	1131	565	424	339	283	242	212	
		(9-13)	Fr	0.013	0.027	0.036	0.045	0.054	0.063	0.072	
			Feed (mm/min)	15	15	15	15	15	15	15	
	TITANIUM ALLOYS Pure Titanium, Ti6Al4V, Ti6Al2Sn4Zr2Mo, Ti4Al4Mo2Sn0.5Si, Ti-6Al4V	≤ 275 Bhn or ≤ 28 HRc	56	RPM	5978	2989	2242	1793	1495	1281	1121
			(45-68)	Fr	0.038	0.076	0.102	0.127	0.153	0.178	0.204
				Feed (mm/min)	229	229	229	229	229	229	229
		≤ 350 Bhn or ≤ 38 HRc	43	RPM	4524	2262	1696	1357	1131	969	848
			(34-51)	Fr	0.028	0.056	0.075	0.094	0.112	0.131	0.150
				Feed (mm/min)	127	127	127	127	127	127	127
≤ 440 Bhn or ≤ 47 HRc		23	RPM	2424	1212	909	727	606	519	454	
		(18-27)	Fr	0.024	0.048	0.064	0.080	0.096	0.112	0.129	
			Feed (mm/min)	58	58	58	58	58	58	58	
H TOOL STEELS A2, D2, H13, L2, M2, P20, S7, T15, W2		≤ 200 Bhn or ≤ 13 HRc	43	RPM	4524	2262	1696	1357	1131	969	848
			(34-51)	Fr	0.048	0.095	0.127	0.159	0.191	0.223	0.255
				Feed (mm/min)	216	216	216	216	216	216	216
	≤ 375 Bhn or ≤ 40 HRc	27	RPM	2908	1454	1091	872	727	623	545	
		(22-33)	Fr	0.026	0.052	0.070	0.087	0.105	0.122	0.140	
			Feed (mm/min)	76	76	76	76	76	76	76	
	≤ 475 Bhn or ≤ 50 HRc	24	RPM	2585	1293	969	776	646	554	485	
		(20-29)	Fr	0.015	0.029	0.039	0.049	0.059	0.069	0.079	
			Feed (mm/min)	38	38	38	38	38	38	38	

Bhn (Brinell) HRc (Rockwell C) HRb (Rockwell B)
 $rpm = (Vc \times 1000) / (DC \times 3.14)$
 $mm/min = Fr \times rpm$
 reduce speed and feed for materials harder than listed
 refer to the SGS Tool Wizard® for complete technical information (www.kyocera-sgstool.com)

Series 120



3xD

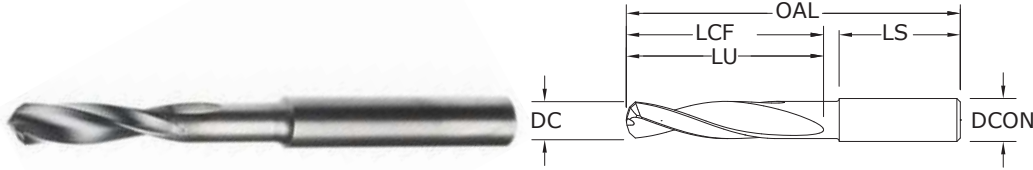

120

FRACTIONAL & METRIC SERIES

- Double margin design stabilizes the drill for greater hole accuracy and improved surface finish
- Notched point reduces thrust force over conventional designs
- 8 facet point reduces fiber breakout and delamination on exit
- 90 degree secondary chamfer angle improves hole entrance and exit quality

CUTTING DIAMETER DC	DECIMAL EQUIV.	METRIC EQUIV.	inch & mm				SHANK LENGTH LS	EDP NO.
			SHANK DIAMETER DCON	OVERALL LENGTH OAL	FLUTE LENGTH LCF/LU	Di-NAMITE® (Diamond)		
#40	0.0980	2.49	1/8	2	9/16	1-1/4	50000	
2,7 mm	0.1063		6,0	63,0	20,0	32,0	50001	
3,0 mm	0.1181		6,0	63,0	20,0	36,0	50002	
1/8	0.1250	3.18	1/4	2-1/2	3/4	1-7/16	50003	
3,2 mm	0.1260		6,0	63,0	20,0	36,0	50004	
#30	0.1285	3.26	1/4	2-1/2	3/4	1-7/16	50005	
#28	0.1405	3.57	1/4	2-1/2	3/4	1-7/16	50006	
#22	0.1570	3.99	1/4	2-5/8	7/8	1-7/16	50007	
#21	0.1590	4.04	1/4	2-5/8	7/8	1-7/16	50008	
4,1 mm	0.1614		6,0	66,0	24,0	36,0	50009	
#19	0.1660	4.22	1/4	2-5/8	7/8	1-7/16	50010	
11/64	0.1719	4.37	1/4	2-5/8	7/8	1-7/16	50011	
3/16	0.1875	4.76	1/4	2-5/8	1	1-7/16	50012	
#11	0.1910	4.85	1/4	2-5/8	1	1-7/16	50013	
#8	0.1990	5.05	1/4	2-5/8	1	1-7/16	50014	
#7	0.2010	5.11	1/4	2-5/8	1	1-7/16	50015	
#2	0.2210	5.61	1/4	2-5/8	1	1-7/16	50016	
6,0 mm	0.2362		6,0	66,0	28,0	36,0	50017	
1/4	0.2500	6.35	1/4	3-1/8	1-5/16	1-7/16	50018	
.2510	0.2510	6.38	5/16	3-1/8	1-5/16	1-7/16	50019	
F	0.2570	6.53	5/16	3-1/8	1-5/16	1-7/16	50020	
I	0.2720	6.91	5/16	3-1/8	1-5/16	1-7/16	50021	
J	0.2770	7.04	5/16	3-1/8	1-5/16	1-7/16	50022	
K	0.2810	7.14	5/16	3-1/8	1-9/16	1-7/16	50023	
5/16	0.3125	7.94	5/16	3-1/8	1-9/16	1-7/16	50024	
8,0 mm	0.3150		8,0	79,0	41,0	36,0	50025	
3/8	0.3750	9.53	3/8	3-1/2	1-27/32	1-9/16	50026	
V	0.3770	9.58	1/2	3-1/2	1-27/32	1-9/16	50027	
10,0 mm	0.3937		10,0	89,0	47,0	40,0	50028	
7/16	0.4375	11.11	1/2	4-1/16	2-3/16	1-9/16	50029	
12,0 mm	0.4724		12,0	102,0	55,0	45,0	50030	
1/2	0.5000	12.70	1/2	4-1/4	2-5/16	1-3/4	50031	

TOLERANCES (inch)

DC = +0.0000/-0.0005
DCON = h₆

TOLERANCES (mm)

DC = +0,000/-0,013
DCON = h₆

PLASTICS/COMPOSITES

For patent information visit www.ksptpatents.com

Series 120 Fractional	Vc (sfm)		DC • in							
			1/8	3/16	1/4	5/16	3/8	7/16	1/2	
N	320 (256-384)	CFRP, AFRP (Carbon Fiber, Aramid Fiber)	RPM	9779	6519	4890	3912	3260	2794	2445
			Fr	0.0006	0.0009	0.0012	0.0015	0.0018	0.0021	0.0024
			Feed (ipm)	5.9	5.9	5.9	5.9	5.9	5.9	5.9
	240 (192-288)	GFRP (Fiberglass)	RPM	7334	4890	3667	2934	2445	2096	1834
			Fr	0.0006	0.0009	0.0012	0.0015	0.0018	0.0021	0.0024
			Feed (ipm)	4.4	4.4	4.4	4.4	4.4	4.4	4.4
400 (320-480)	CARBON, GRAPHITE	RPM	12224	8149	6112	4890	4075	3493	3056	
		Fr	0.0008	0.0012	0.0016	0.0020	0.0024	0.0028	0.0032	
		Feed (ipm)	9.8	9.8	9.8	9.8	9.8	9.8	9.8	

rpm = Vc x 3.82 / DC
ipm = Fr x rpm
adjust speed and / or feed based on resin type and / or fiber structure
refer to the SGS Tool Wizard® for complete technical information (www.kyocera-sgstool.com)

Series 120 Metric	Vc (m/min)		DC • mm							
			2.5	3	4	6	8	10	12	
N	100 (80-120)	CFRP, AFRP (Carbon Fiber, Aramid Fiber)	RPM	12722	10602	7951	5301	3976	3181	2650
			Fr	0.012	0.014	0.019	0.028	0.038	0.047	0.057
			Feed (mm/min)	150	150	150	150	150	150	150
	75 (65-90)	GFRP (Fiberglass)	RPM	9542	7951	5963	3976	2982	2385	1988
			Fr	0.012	0.014	0.019	0.029	0.039	0.048	0.058
			Feed (mm/min)	115	115	115	115	115	115	115
120 (96-144)	CARBON, GRAPHITE	RPM	15266	12722	9542	6361	4771	3817	3181	
		Fr	0.015	0.018	0.025	0.037	0.049	0.062	0.074	
		Feed (mm/min)	235	235	235	235	235	235	235	

rpm = (Vc x 1000) / (DC x 3.14)
mm/min = Fr x rpm
adjust speed and / or feed based on resin type and / or fiber structure
refer to the SGS Tool Wizard® for complete technical information (www.kyocera-sgstool.com)

General Purpose Drills



Hole Making

GENERAL PURPOSE DRILLS	SERIES	DESCRIPTION	PAGE
2 Flute	101	2 Flute Slow Spiral	288
Short Length Self Centering (DIN6539)	108M Plus	2 Flute Short Length DIN 6539	293
Straight Flute	106	Straight Flute 140 Point Geometry	300
3 Flute with 150 Point Geometry	103	3 Flute 150 Point Geometry	304

GENERAL PURPOSE COUNTERSINKS	SERIES	DESCRIPTION	PAGE
Combined Drill & Countersink	301	2 Flute Straight Flute Combined Drill and Countersink Fractional	310
	301M	2 Flute Straight Flute Combined Drill and Countersink Metric	311
Single Flute Countersink	601	Single Flute Fractional	316
3 Flute Countersink	603	3 Flute Fractional	319
6 Flute Countersink	606	6 Flute Fractional	322

GENERAL PURPOSE REAMERS	SERIES	DESCRIPTION	PAGE
Straight Flute Accu-Reamer	200	Accu-Reamer	326
Straight Flute Reamer	201M	Metric Reamer	330

Speed & Feed Recommendations listed after each series

Taladrado

BROCAS DE USO GENERAL	SERIE	DESCRIPCIÓN	PÁGINA
2 filos	101	2 filos, espiral de avance lento	288
Autocentrante de longitud corta (DIN6539)	108M Plus	2 filos, longitud corta, DIN 6539	293
Filo recto	106	Filo recto, geometría de 140 puntos	300
3 filos con geometría de 150 puntos	103	3 filos, geometría de 150 puntos	304

BROCAS DE USO AVELLANADORES	SERIE	DESCRIPCIÓN	PÁGINA
Broca y avellanador combinados	301	2 filos, filo recto, broca y avellanador combinados, fraccional	310
	301M	2 filos, filo recto, broca y avellanador combinados, métrico	311
Avellanador de filo único	601	Filo único, fraccional	316
Avellanador de 3 filos	603	3 filos, fraccional	319
Avellanador de 6 filos	606	6 filos, fraccional	322

BROCAS DE USO ESCARIADORES	SERIE	DESCRIPCIÓN	PÁGINA
Escariador Accu de filo recto	200	Escariador Accu	326
Escariador de filo recto	201M	Escariador métrico	330

Recomendaciones de velocidades y avances mostradas tras cada serie

Outils de perçage

FORETS UNIVERSELS	SÉRIES	DESCRIPTION	PAGE
2 dents	101	2 dents à spirale lente	288
Court autocentrant (DIN 6539)	108M Plus	2 dents court DIN 6539	293
Denture droite	106	Denture droite à angle de pointe 140°	300
3 dents à angle de pointe 150°	103	3 dents à angle de pointe 150°	304

FORETS À FRAISER	SÉRIES	DESCRIPTION	PAGE
Foret et foret à fraiser combinés	301	2 dents denture droite foret et foret à fraiser combinés (fractionnel)	310
	301M	2 dents denture droite foret et foret à fraiser combinés (métrique)	311
Foret à fraiser à dent simple	601	Foret à dent simple (fractionnel)	316
Foret à fraiser 3 dents	603	3 dents (fractionnel)	319
Foret à fraiser 6 dents	606	6 dents (fractionnel)	322

FORETS À ALÉSOIRS	SÉRIES	DESCRIPTION	PAGE
Alésoir denture droite Accu-Reamer	200	Alésoir Accu-Reamer	326
Alésoir denture droite	201M	Alésoir (métrique)	330

Recommandations de vitesse et avance indiquées après chaque série

STANDARD-BOHRER	SERIE	BESCHREIBUNG	SEITE
2 Schneiden	101	2 Schneiden mit kleinem Spanwinkel	288
Kurze Bauform Selbstzentrierung (DIN 6539)	108M Plus	2 Schneiden Kurze Bauform DIN 6539	293
Gerade Schneiden	106	Gerade Schneiden Spitzengeometrie 140	300
3 Schneiden mit Spitzengeometrie 150	103	3 Schneiden Spitzengeometrie 150	304

STANDARD-BOHRER	SERIE	BESCHREIBUNG	SEITE
Senkbohrer	301	Zölliger Senkbohrer mit 2 geraden Schneiden	310
	301M	Metrischer Senkbohrer mit 2 geraden Schneiden	311
Senker mit 1 Schneide	601	Zölliger Bohrer mit 1 Schneide	316
Senkbohrer mit 1 Schneide	603	Zölliger Bohrer mit 3 Schneiden	319
Senkbohrer mit 6 Schneiden	606	Zölliger Bohrer mit 6 Schneiden	322

STANDARD-BOHRER	SERIE	BESCHREIBUNG	SEITE
Reibahlen mit gerader Schneide	200	Accu-Reamer	326
Reibahle mit gerader Schneide	201M	Metrische Reibahle	330

Empfehlungen für Drehzahl & Vorschub im Anhang zu jeder Serie

2 Flute Drills • Metric: DIN 338



5xD

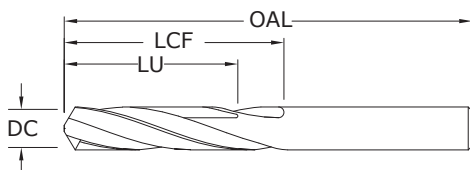

101

FRACTIONAL & METRIC SERIES

Pictured:
Series 101 Drill Set



CUTTING DIAMETER DC	DECIMAL EQUIV.	METRIC EQUIV.	OVERALL LENGTH OAL	FLUTE LENGTH LCF	CLEARED LENGTH LU	EDP NO.	
						UNCOATED	Ti-NAMITE-A (AITiN)
#80	0.0135	0.34	3/4	3/16	—	51080	57076
#79	0.0145	0.37	3/4	3/16	—	51079	57077
1/64	0.0156	0.40	3/4	3/16	—	51101	57078
#78	0.0160	0.41	3/4	3/16	—	51078	57079
#77	0.0180	0.46	3/4	3/16	—	51077	57080
#76	0.0200	0.51	7/8	1/4	—	51076	57081
#75	0.0210	0.53	7/8	1/4	—	51075	57082
#74	0.0225	0.57	7/8	1/4	—	51074	57083
#73	0.0240	0.61	7/8	1/4	—	51073	57084
#72	0.0250	0.64	1	5/16	—	51072	57085
#71	0.0260	0.66	1	5/16	—	51071	57086
0,7 mm	0.0276		28,0	9,0	—	61001	68268
#70	0.0280	0.71	1-1/4	1/2	—	51070	57087
#69	0.0292	0.74	1-1/4	1/2	—	51069	57088
#68	0.0310	0.79	1-1/4	1/2	—	51068	57089
1/32	0.0312	0.79	1-1/4	1/2	—	51102	57090
0,8 mm	0.0315		30,0	10,0	—	61003	68269
#67	0.0320	0.81	1-1/4	1/2	—	51067	57091
#66	0.0330	0.84	1-1/4	1/2	—	51066	57092
#65	0.0350	0.89	1-3/8	5/8	1/2	51065	57093
0,9 mm	0.0354		32,0	11,0	8,0	61005	68270
#64	0.0360	0.91	1-3/8	5/8	1/2	51064	57094
#63	0.0370	0.94	1-3/8	5/8	1/2	51063	57095
#62	0.0380	0.97	1-3/8	5/8	1/2	51062	57096
#61	0.0390	0.99	1-3/8	5/8	1/2	51061	57097
1,0 mm	0.0394		34,0	12,0	9,0	61007	68271
#60	0.0400	1.02	1-1/2	3/4	39/64	51060	57098
#59	0.0410	1.04	1-1/2	3/4	39/64	51059	57099
#58	0.0420	1.07	1-1/2	3/4	39/64	51058	57100
#57	0.0430	1.09	1-1/2	3/4	39/64	51057	57101
1,1 mm	0.0433		36,0	14,0	11,0	61052	68294
#56	0.0465	1.18	1-1/2	3/4	39/64	51056	57102
3/64	0.0469	1.19	1-1/2	3/4	39/64	51103	57103
1,2 mm	0.0472		38,0	16,0	12,0	61053	68295
1,3 mm	0.0512		38,0	16,0	12,0	61054	68296
#55	0.0520	1.32	1-1/2	3/4	39/64	51055	57104
#54	0.0550	1.40	1-1/2	3/4	39/64	51054	57105
1,4 mm	0.0551		40,0	18,0	14,0	61055	68297
1,5 mm	0.0591		40,0	18,0	14,0	61009	68272
#53	0.0595	1.51	1-1/2	3/4	39/64	51053	57106
*1/16	0.0625	1.59	1-1/2	3/4	39/64	51104	57107
1,6 mm	0.0630		43,0	20,0	16,0	61056	68298
#52	0.0635	1.61	1-1/2	3/4	39/64	51052	57108
1,7 mm	0.0669		43,0	20,0	17,0	61057	68299

TOLERANCES (inch)

DC = +0.0000/-0.0005

TOLERANCES (mm)

DC = +0,0000/-0,0127

- STEELS
- STAINLESS STEELS
- CAST IRON
- HIGH TEMP ALLOYS
- TITANIUM
- HARDENED STEELS
- NON-FERROUS
- PLASTICS/COMPOSITES

For patent information visit www.ksptpatents.com

continued on next page

2 Flute Drills • Metric: DIN 338

101

FRACTIONAL & METRIC SERIES

CONTINUED

CUTTING DIAMETER DC	DECIMAL EQUIV.	METRIC EQUIV.	OVERALL LENGTH OAL	FLUTE LENGTH LCF	CLEARED LENGTH LU	EDP NO.	
						UNCOATED	Ti-NAMITE-A (AITIN)
#51	0.0670	1.70	1-1/2	3/4	39/64	51051	57109
#50	0.0700	1.78	1-3/4	7/8	45/64	51050	57110
1,8 mm	0.0709		46,0	22,0	17,0	61058	68300
#49	0.0730	1.85	1-3/4	7/8	45/64	51049	57111
1,9 mm	0.0748		46,0	22,0	17,0	61059	68301
#48	0.0760	1.93	1-3/4	7/8	45/64	51048	57112
5/64	0.0781	1.98	1-3/4	7/8	45/64	51105	57113
#47	0.0785	1.99	1-3/4	7/8	45/64	51047	57114
2,0 mm	0.0787		49,0	24,0	19,0	61011	68273
#46	0.0810	2.06	1-3/4	7/8	45/64	51046	57115
#45	0.0820	2.08	1-3/4	7/8	45/64	51045	57116
2,1 mm	0.0827		49,0	24,0	19,0	61060	68302
#44	0.0860	2.18	2	1	51/64	51044	57117
2,2 mm	0.0866		53,0	27,0	21,0	61061	68303
#43	0.0890	2.26	2	1	51/64	51043	57118
2,3 mm	0.0906		53,0	27,0	21,0	61062	68304
#42	0.0935	2.37	2	1	51/64	51042	57119
3/32	0.0938	2.38	2	1	51/64	51106	57120
2,4 mm	0.0945		57,0	30,0	24,0	61063	68305
#41	0.0960	2.44	2	1	51/64	51041	57121
#40	0.0980	2.49	2	1	51/64	51040	57122
2,5 mm	0.0984		57,0	30,0	24,0	61013	68274
#39	0.0995	2.53	2-1/4	1-1/4	1	51039	57123
#38	0.1015	2.58	2-1/4	1-1/4	1	51038	57124
2,6 mm	0.1024		57,0	30,0	24,0	61064	68306
#37	0.1040	2.64	2-1/4	1-1/4	1	51037	57125
2,7 mm	0.1063		61,0	33,0	26,0	61065	68307
#36	0.1065	2.71	2-1/4	1-1/4	1	51036	57126
7/64	0.1094	2.78	2-1/4	1-1/4	1	51107	57127
#35	0.1100	2.79	2-1/4	1-1/4	1	51035	57128
2,8 mm	0.1102		61,0	33,0	26,0	61066	68308
#34	0.1110	2.82	2-1/4	1-1/4	1	51034	57129
#33	0.1130	2.87	2-1/4	1-1/4	1	51033	57130
2,9 mm	0.1142		61,0	33,0	26,0	61067	68309
#32	0.1160	2.95	2-1/4	1-1/4	1	51032	57131
3,0 mm	0.1181		61,0	33,0	26,0	61015	68275
#31	0.1200	3.05	2-1/4	1-1/4	1	51031	57132
3,1 mm	0.1220		65,0	36,0	28,0	61068	68310
*1/8	0.1250	3.18	2-1/4	1-1/4	1	51108	57133
3,2 mm	0.1260		65,0	36,0	28,0	61069	68311
#30	0.1285	3.26	2-1/4	1-1/4	1	51030	57134
3,3 mm	0.1299		65,0	36,0	28,0	61070	68312
3,4 mm	0.1339		70,0	39,0	31,0	61071	68313
#29	0.1360	3.45	2-1/2	1-3/8	1-7/64	51029	57135
3,5 mm	0.1378		70,0	39,0	31,0	61017	68276
#28	0.1405	3.57	2-1/2	1-3/8	1-7/64	51028	57136
9/64	0.1406	3.57	2-1/2	1-3/8	1-7/64	51109	57137
3,6 mm	0.1417		70,0	39,0	31,0	61072	68314
#27	0.1440	3.66	2-1/2	1-3/8	1-7/64	51027	57138
3,7 mm	0.1457		70,0	39,0	31,0	61073	68315
#26	0.1470	3.73	2-1/2	1-3/8	1-7/64	51026	57139
#25	0.1495	3.80	2-1/2	1-3/8	1-7/64	51025	57140
3,8 mm	0.1496		75,0	43,0	34,0	61074	68316
#24	0.1520	3.86	2-1/2	1-3/8	1-7/64	51024	57141

continued on next page

2 Flute Drills • Metric: DIN 338



5xD

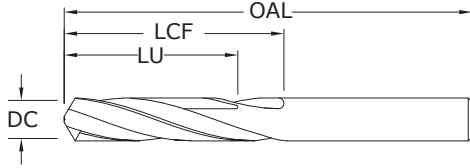

Pictured:
Series 101 Drill Set



101

FRACTIONAL & METRIC SERIES

CONTINUED

CUTTING DIAMETER DC	DECIMAL EQUIV.	METRIC EQUIV.	OVERALL LENGTH OAL	FLUTE LENGTH LCF	CLEARED LENGTH LU	EDP NO.	
						UNCOATED	Ti-NAMITE-A (AITiN)
3,9 mm	0.1535		75,0	43,0	34,0	61075	68317
#23	0.1540	3.91	2-1/2	1-3/8	1-7/64	51023	57142
5/32	0.1562	3.97	2-1/2	1-3/8	1-7/64	51110	57143
#22	0.1570	3.99	2-1/2	1-3/8	1-7/64	51022	57144
4,0 mm	0.1575		75,0	43,0	34,0	61019	68277
#21	0.1590	4.04	2-1/2	1-3/8	1-7/64	51021	57145
#20	0.1610	4.09	2-1/2	1-3/8	1-7/64	51020	57146
4,1 mm	0.1614		75,0	43,0	34,0	61076	68318
4,2 mm	0.1654		75,0	43,0	34,0	61077	68319
#19	0.1660	4.22	2-1/2	1-5/8	1-19/64	51019	57147
4,3 mm	0.1693		80,0	47,0	37,0	61078	68320
#18	0.1695	4.31	2-3/4	1-5/8	1-19/64	51018	57148
11/64	0.1719	4.37	2-3/4	1-5/8	1-19/64	51111	57149
#17	0.1730	4.39	2-3/4	1-5/8	1-19/64	51017	57150
4,4 mm	0.1732		80,0	47,0	37,0	61079	68321
#16	0.1770	4.50	2-3/4	1-5/8	1-19/64	51016	57151
4,5 mm	0.1772		80,0	47,0	37,0	61021	68278
#15	0.1800	4.57	2-3/4	1-5/8	1-19/64	51015	57152
4,6 mm	0.1811		80,0	47,0	37,0	61080	68322
#14	0.1820	4.62	2-3/4	1-5/8	1-19/64	51014	57153
4,7 mm	0.1850		80,0	47,0	37,0	61081	68323
#13	0.1850	4.70	2-3/4	1-5/8	1-19/64	51013	57154
*3/16	0.1875	4.76	2-3/4	1-5/8	1-19/64	51112	57155
4,8 mm	0.1890		86,0	52,0	41,0	61082	68324
#12	0.1890	4.80	2-3/4	1-5/8	1-19/64	51012	57156
#11	0.1910	4.85	2-3/4	1-5/8	1-19/64	51011	57157
4,9 mm	0.1929		86,0	52,0	41,0	61083	68325
#10	0.1935	4.91	2-3/4	1-5/8	1-19/64	51010	57158
#9	0.1960	4.98	3	1-3/4	1-13/32	51009	57159
5,0 mm	0.1969		86,0	52,0	41,0	61023	68279
#8	0.1990	5.05	3	1-3/4	1-13/32	51008	57160
5,1 mm	0.2008		86,0	52,0	41,0	61084	68326
#7	0.2010	5.11	3	1-3/4	1-13/32	51007	57161
13/64	0.2031	5.16	3	1-3/4	1-13/32	51113	57162
#6	0.2040	5.18	3	1-3/4	1-13/32	51006	57163
5,2 mm	0.2047		86,0	52,0	41,0	61085	68327
#5	0.2055	5.22	3	1-3/4	1-13/32	51005	57164
5,3 mm	0.2087		86,0	52,0	41,0	61086	68328
#4	0.2090	5.31	3	1-3/4	1-13/32	51004	57165
5,4 mm	0.2126		93,0	57,0	45,0	61087	68329
#3	0.2130	5.41	3	1-3/4	1-13/32	51003	57166
5,5 mm	0.2165		93,0	57,0	45,0	61025	68280
7/32	0.2188	5.56	3	1-3/4	1-13/32	51114	57167
5,6 mm	0.2205		93,0	57,0	45,0	61088	68330

TOLERANCES (inch)

DC = +0.0000/-0.0005

TOLERANCES (mm)

DC = +0,0000/-0,0127

- STEELS
- STAINLESS STEELS
- CAST IRON
- HIGH TEMP ALLOYS
- TITANIUM
- HARDENED STEELS
- NON-FERROUS
- PLASTICS/COMPOSITES

For patent information visit
www.ksptpatents.com

continued on next page

2 Flute Drills • Metric: DIN 338

101

FRACTIONAL & METRIC SERIES

CONTINUED

CUTTING DIAMETER DC	DECIMAL EQUIV.	METRIC EQUIV.	OVERALL LENGTH OAL	FLUTE LENGTH LCF	CLEARED LENGTH LU	EDP NO.	
						UNCOATED	Ti-NAMITE-A (AITIN)
#2	0.2210	5.61	3	1-3/4	1-13/32	51002	57168
5,7 mm	0.2244		93,0	57,0	45,0	61089	68331
#1	0.2280	5.79	3	1-3/4	1-13/32	51001	57169
5,8 mm	0.2283		93,0	57,0	45,0	61090	68332
5,9 mm	0.2323		93,0	57,0	45,0	61091	68333
A	0.2340	5.94	3-1/4	2	1-39/64	51201	57170
15/64	0.2344	5.95	3-1/4	2	1-39/64	51115	57171
6,0 mm	0.2362		93,0	57,0	45,0	61027	68281
B	0.2380	6.05	3-1/4	2	1-39/64	51202	57172
6,1 mm	0.2402		101,0	63,0	50,0	61092	68334
C	0.2420	6.15	3-1/4	2	1-39/64	51203	57173
6,2 mm	0.2441		101,0	63,0	50,0	61093	68335
D	0.2460	6.25	3-1/4	2	1-39/64	51204	57174
6,3 mm	0.2480		101,0	63,0	50,0	61094	68336
*1/4	0.2500	6.35	3-1/4	2	1-39/64	51116	57176
6,4 mm	0.2520		101,0	63,0	50,0	61095	68337
6,5 mm	0.2559		101,0	63,0	50,0	61029	68282
F	0.2570	6.53	3-1/4	2	1-39/64	51206	57177
6,6 mm	0.2598		101,0	63,0	50,0	61096	68338
G	0.2610	6.63	3-1/2	2-1/8	1-45/64	51207	57178
6,7 mm	0.2638		101,0	63,0	50,0	61097	68339
17/64	0.2656	6.75	3-1/2	2-1/8	1-45/64	51117	57179
H	0.2660	6.76	3-1/2	2-1/8	1-45/64	51208	57180
6,8 mm	0.2677		109,0	69,0	55,0	61098	68340
6,9 mm	0.2717		109,0	69,0	55,0	61099	68341
I	0.2720	6.91	3-1/2	2-1/8	1-45/64	51209	57181
7,0 mm	0.2756		109,0	69,0	55,0	61031	68283
J	0.2770	7.04	3-1/2	2-1/8	1-45/64	51210	57182
7,1 mm	0.2795		109,0	69,0	55,0	61100	68342
K	0.2810	7.14	3-1/2	2-1/8	1-45/64	51211	57183
9/32	0.2812	7.14	3-1/2	2-1/8	1-45/64	51118	57184
7,2 mm	0.2835		109,0	69,0	55,0	61101	68343
7,3 mm	0.2874		109,0	69,0	55,0	61102	68344
L	0.2900	7.37	3-1/2	2-1/8	1-45/64	51212	57185
7,4 mm	0.2913		109,0	69,0	55,0	61103	68345
M	0.2950	7.49	3-3/4	2-3/8	1-29/32	51213	57186
7,5 mm	0.2953		109,0	69,0	55,0	61033	68284
19/64	0.2969	7.54	3-3/4	2-3/8	1-29/32	51119	57187
7,6 mm	0.2992		117,0	75,0	60,0	61104	68346
N	0.3020	7.67	3-3/4	2-3/8	1-29/32	51214	57188
7,7 mm	0.3031		117,0	75,0	60,0	61105	68347
7,8 mm	0.3071		117,0	75,0	60,0	61106	68348
7,9 mm	0.3110		117,0	75,0	60,0	61107	68349
*5/16	0.3125	7.94	3-3/4	2-3/8	1-29/32	51120	57189
8,0 mm	0.3150		117,0	75,0	60,0	61035	68285
O	0.3160	8.03	3-3/4	2-3/8	1-29/32	51215	57190
8,1 mm	0.3189		117,0	75,0	60,0	61108	68350
8,2 mm	0.3228		117,0	75,0	60,0	61109	68351
P	0.3230	8.20	3-3/4	2-3/8	1-29/32	51216	57191
8,3 mm	0.3268		117,0	75,0	60,0	61110	68352
21/64	0.3281	8.33	4	2-1/2	2	51121	57192
8,4 mm	0.3307		117,0	75,0	60,0	61111	68353
Q	0.3320	8.43	4	2-1/2	2	51217	57193
8,5 mm	0.3346		117,0	75,0	60,0	61037	68286

continued on next page

2 Flute Drills • Metric: DIN 338



5xD



Pictured:
Series 101 Drill Set

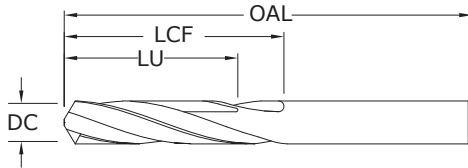

101

FRACTIONAL & METRIC SERIES

CONTINUED

CUTTING DIAMETER DC	DECIMAL EQUIV.	METRIC EQUIV.	OVERALL LENGTH OAL	FLUTE LENGTH LCF	CLEARED LENGTH LU	EDP NO.	
						UNCOATED	Ti-NAMITE-A (AITiN)
8,6 mm	0.3386		125,0	81,0	64,0	61112	68354
R	0.3390	8.61	4	2-1/2	2	51218	57194
8,7 mm	0.3425		125,0	81,0	64,0	61113	68355
11/32	0.3438	8.73	4	2-1/2	2	51122	57195
8,8 mm	0.3465		125,0	81,0	64,0	61114	68356
S	0.3480	8.84	4	2-1/2	2	51219	57196
8,9 mm	0.3504		125,0	81,0	64,0	61115	68357
9,0 mm	0.3543		125,0	81,0	64,0	61039	68287
T	0.3580	9.09	4-1/4	2-3/4	2-13/64	51220	57197
9,1 mm	0.3583		125,0	81,0	64,0	61116	68358
23/64	0.3594	9.13	4-1/4	2-3/4	2-13/64	51123	57198
9,2 mm	0.3622		125,0	81,0	64,0	61117	68359
9,3 mm	0.3661		125,0	81,0	64,0	61118	68360
U	0.3680	9.35	4-1/4	2-3/4	2-13/64	51221	57199
9,4 mm	0.3701		125,0	81,0	64,0	61119	68361
9,5 mm	0.3740		125,0	81,0	64,0	61041	68288
*3/8	0.3750	9.53	4-1/4	2-3/4	2-13/64	51124	57200
V	0.3770	9.58	4-1/4	2-3/4	2-13/64	51222	57201
9,6 mm	0.3780		133,0	87,0	69,0	61120	68362
9,7 mm	0.3819		133,0	87,0	69,0	61121	68363
9,8 mm	0.3858		133,0	87,0	69,0	61122	68364
W	0.3860	9.80	4-1/2	2-7/8	2-19/64	51223	57202
9,9 mm	0.3898		133,0	87,0	69,0	61123	68365
25/64	0.3906	9.92	4-1/2	2-7/8	2-19/64	51125	57203
10,0 mm	0.3937		133,0	87,0	69,0	61043	68289
X	0.3970	10.08	4-1/2	2-7/8	2-19/64	51224	57204
10,2 mm	0.4016		133,0	87,0	69,0	61124	68366
Y	0.4040	10.26	4-1/2	2-7/8	2-19/64	51225	57205
13/32	0.4062	10.32	4-1/2	2-7/8	2-19/64	51126	57206
Z	0.4130	10.49	4-1/2	2-7/8	2-19/64	51226	57207
10,5 mm	0.4134		133,0	87,0	69,0	61045	68290
27/64	0.4219	10.72	4-1/2	2-7/8	2-19/64	51127	57208
11,0 mm	0.4331		142,0	94,0	75,0	61047	68291
7/16	0.4375	11.11	4-1/2	2-7/8	2-19/64	51128	57209
11,5 mm	0.4528		142,0	94,0	75,0	61049	68292
29/64	0.4531	11.51	4-3/4	3	2-13/32	51129	57210
15/32	0.4688	11.91	4-3/4	3	2-13/32	51130	57211
12,0 mm	0.4724		151,0	101,0	80,0	61051	68293
31/64	0.4844	12.30	4-3/4	3	2-13/32	51131	57212
1/2	0.5000	12.70	4-3/4	3	2-13/32	51132	57213
*Series 101 Set						61175	57351

TOLERANCES (inch)

DC = +0.0000/-0.0005

TOLERANCES (mm)

DC = +0.0000/-0.0127

- STEELS
- STAINLESS STEELS
- CAST IRON
- HIGH TEMP ALLOYS
- TITANIUM
- HARDENED STEELS
- NON-FERROUS
- PLASTICS/COMPOSITES

For patent information visit www.ksptpatents.com

Short Length Self Centering Drills • DIN 6539

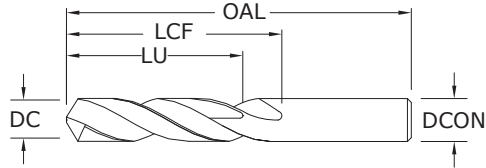
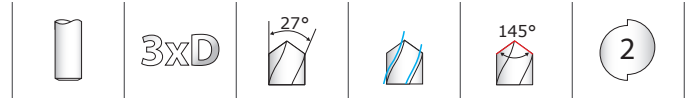

108M Plus
METRIC SERIES

TOLERANCES (mm)

≤3 DIAMETER

DC = +0,000/-0,010
DCON = h₆

>3-6 DIAMETER

DC = +0,000/-0,012
DCON = h₆

>6-10 DIAMETER

DC = +0,000/-0,015
DCON = h₆

>10-18 DIAMETER

DC = +0,000/-0,018
DCON = h₆

STEELS

STAINLESS STEELS

CAST IRON

HIGH TEMP ALLOYS

TITANIUM

HARDENED STEELS

NON-FERROUS

PLASTICS/COMPOSITES

For patent information visit www.kspatents.com

	mm				EDP NO.	
	CUTTING DIAMETER DC / DCON	OVERALL LENGTH OAL	FLUTE LENGTH LCF	CLEARED LENGTH LU	UNCOATED	Ti-NAMITE-A (AlTiN)
	0,5	20,0	3,0	—	62001	68643
	0,55	21,0	3,5	—	62003	68644
	0,6	21,0	3,5	—	62005	68645
	0,65	22,0	4,0	—	62007	68646
	0,7	23,0	4,5	—	62009	68647
	0,75	23,0	4,5	—	62011	68648
	0,8	24,0	5,0	—	62013	68649
	0,85	24,0	5,0	—	62015	68650
	0,9	25,0	5,5	4,0	62017	68651
	0,95	25,0	5,5	4,0	62019	68652
	1,0	26,0	6,0	4,7	62021	68653
	1,05	26,0	6,0	4,7	62023	68654
	1,1	28,0	7,0	5,4	62025	68655
	1,15	28,0	7,0	5,4	62027	68656
	1,2	30,0	8,0	6,0	62029	68657
	1,25	30,0	8,0	6,0	62031	68658
	1,3	30,0	8,0	6,0	62033	68659
	1,35	32,0	9,0	7,0	62035	68660
	1,4	32,0	9,0	7,0	62037	68661
	1,45	32,0	9,0	7,0	62039	68662
	1,5	32,0	9,0	7,0	62041	68663
	1,6	34,0	10,0	7,0	62043	68664
	1,7	34,0	10,0	7,0	62045	68665
	1,8	36,0	11,0	8,0	62047	68666
	1,9	36,0	11,0	8,0	62049	68667
	2,0	38,0	12,0	9,0	62051	68668
	2,1	38,0	12,0	9,0	62053	68669
	2,2	40,0	13,0	10,0	62055	68670
	2,3	40,0	13,0	10,0	62057	68671
	2,4	43,0	14,0	11,0	62059	68672
	2,5	43,0	14,0	11,0	62061	68673
	2,6	43,0	14,0	11,0	62063	68674
	2,7	46,0	16,0	12,0	62065	68675
	2,8	46,0	16,0	12,0	62067	68676

continued on next page

Short Length Self Centering Drills • DIN 6539



3xD



108M Plus

METRIC SERIES

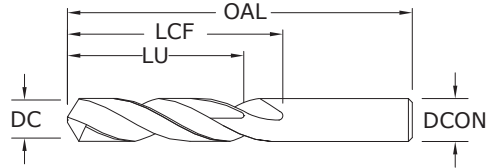

CONTINUED

CUTTING DIAMETER DC/DCON	mm			EDP NO.	
	OVERALL LENGTH OAL	FLUTE LENGTH LCF	CLEARED LENGTH LU	UNCOATED	Ti-NAMITE-A (AlTiN)
2,9	46,0	16,0	12,0	62069	68677
3,0	46,0	16,0	12,0	62071	68678
3,1	49,0	18,0	14,0	62073	68679
3,2	49,0	18,0	14,0	62075	68680
3,3	49,0	18,0	14,0	62077	68681
3,4	52,0	20,0	15,0	62079	68682
3,5	52,0	20,0	15,0	62081	68683
3,6	52,0	20,0	15,0	62083	68684
3,7	52,0	20,0	15,0	62085	68685
3,8	55,0	22,0	17,0	62087	68686
3,9	55,0	22,0	17,0	62089	68687
4,0	55,0	22,0	17,0	62091	68688
4,1	55,0	22,0	17,0	62093	68689
4,2	55,0	22,0	17,0	62095	68690
4,3	58,0	24,0	18,0	62097	68691
4,4	58,0	24,0	18,0	62099	68692
4,5	58,0	24,0	18,0	62101	68693
4,6	58,0	24,0	18,0	62103	68694
4,7	58,0	24,0	18,0	62105	68695
4,8	62,0	26,0	20,0	62107	68696
4,9	62,0	26,0	20,0	62109	68697
5,0	62,0	26,0	20,0	62111	68698
5,1	62,0	26,0	20,0	62113	68699
5,2	62,0	26,0	20,0	62115	68700
5,3	62,0	26,0	20,0	62117	68701
5,4	66,0	28,0	21,0	62119	68702
5,5	66,0	28,0	21,0	62121	68703
5,6	66,0	28,0	21,0	62123	68704
5,7	66,0	28,0	21,0	62125	68705
5,8	66,0	28,0	21,0	62127	68706
5,9	66,0	28,0	21,0	62129	68707
6,0	66,0	28,0	21,0	62131	68708

TOLERANCES (mm)

≤3 DIAMETER

DC = +0,000/-0,010

DCON = h₆

>3-6 DIAMETER

DC = +0,000/-0,012

DCON = h₆

>6-10 DIAMETER

DC = +0,000/-0,015

DCON = h₆

>10-16 DIAMETER

DC = +0,000/-0,018

DCON = h₆

- STEELS
- STAINLESS STEELS
- CAST IRON
- HIGH TEMP ALLOYS
- TITANIUM
- HARDENED STEELS
- NON-FERROUS
- PLASTICS/COMPOSITES

For patent information visit www.ksptpatents.com

continued on next page

Short Length Self Centering Drills • DIN 6539

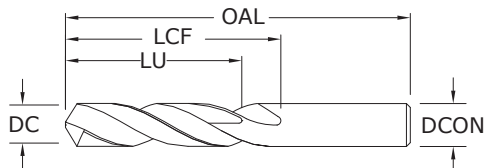
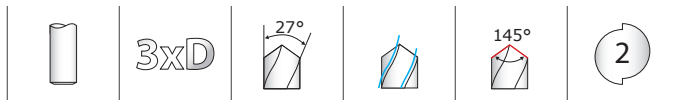

108M Plus
METRIC SERIES

TOLERANCES (mm)

- ≤3 DIAMETER**
DC = +0,000/-0,010
DCON = h₆
- >3-6 DIAMETER**
DC = +0,000/-0,012
DCON = h₆
- >6-10 DIAMETER**
DC = +0,000/-0,015
DCON = h₆
- >10-16 DIAMETER**
DC = +0,000/-0,018
DCON = h₆

- STEELS
- STAINLESS STEELS
- CAST IRON
- HIGH TEMP ALLOYS
- TITANIUM
- HARDENED STEELS
- NON-FERROUS
- PLASTICS/COMPOSITES

For patent information visit www.ksptpatents.com

CUTTING DIAMETER DC / DCON	mm			EDP NO.	
	OVERALL LENGTH OAL	FLUTE LENGTH LCF	CLEARED LENGTH LU	UNCOATED	Ti-NAMITE-A (AITiN)
6,1	70,0	31,0	23,0	62133	68709
6,2	70,0	31,0	23,0	62135	68710
6,3	70,0	31,0	23,0	62137	68711
6,4	70,0	31,0	23,0	62139	68712
6,5	70,0	31,0	23,0	62141	68713
6,8	70,0	31,0	23,0	62142	68603
7,0	74,0	34,0	25,0	62143	68718
7,5	74,0	34,0	25,0	62145	68723
7,8	79,0	37,0	27,0	62146	68604
8,0	79,0	37,0	27,0	62147	68728
8,5	79,0	37,0	27,0	62149	68733
9,0	84,0	40,0	29,0	62151	68738
9,5	84,0	40,0	29,0	62153	68743
9,8	89,0	43,0	31,0	62154	68606
10,0	89,0	43,0	31,0	62155	68748
10,2	89,0	43,0	31,0	62156	68607
10,5	89,0	43,0	31,0	62066	68753
11,0	95,0	47,0	33,0	62157	68758
11,5	95,0	47,0	33,0	62084	68763
11,8	102,0	51,0	35,0	62158	68608
12,0	102,0	51,0	35,0	62159	68768
12,5	102,0	51,0	35,0	62102	68773
13,0	102,0	51,0	35,0	62112	68778
13,8	107,0	54,0	37,0	62164	68609
14,0	107,0	54,0	37,0	62116	68780
14,5	111,0	56,0	38,0	62166	68611
14,8	111,0	56,0	38,0	62167	68612
15,0	111,0	56,0	38,0	62168	68613
15,8	115,0	58,0	38,0	62170	68614
16,0	115,0	58,0	38,0	62171	68616

CONTINUED

2 Flute Drills

Series 101 Fractional	Hardness	Vc (sfm)	DC • in								
			1/64	1/32	1/16	1/8	1/4	3/8	1/2		
P CARBON STEELS 1018, 1040, 1080, 1090, 10L50, 1140, 1212, 12L15, 1525, 1536	≤ 175 Bhn or ≤ 7 HRc	265	RPM	64787	32394	16197	8098	4049	2699	2025	
		(212-318)	Fr	0.00021	0.0004	0.0008	0.0017	0.0033	0.0050	0.0067	
			Feed (ipm)	13.5	13.5	13.5	13.5	13.5	13.5	13.5	
	≤ 300 Bhn or ≤ 32 HRc	125	RPM	30560	15280	7640	3820	1910	1273	955	
		(100-150)	Fr	0.00020	0.0004	0.0008	0.0016	0.0031	0.0047	0.0063	
			Feed (ipm)	6.0	6.0	6.0	6.0	6.0	6.0	6.0	
	≤ 425 Bhn or ≤ 45 HRc	85	RPM	20781	10390	5195	2598	1299	866	649	
		(68-102)	Fr	0.00011	0.0002	0.0004	0.0008	0.0017	0.0025	0.0034	
			Feed (ipm)	2.2	2.2	2.2	2.2	2.2	2.2	2.2	
	M ALLOY STEELS 4140, 4150, 4320, 5120, 5150, 8630, 86L20, 50100	≤ 275 Bhn or ≤ 28 HRc	230	RPM	56230	28115	14058	7029	3514	2343	1757
			(184-276)	Fr	0.00019	0.0004	0.0007	0.0015	0.0030	0.0045	0.0060
				Feed (ipm)	10.5	10.5	10.5	10.5	10.5	10.5	10.5
≤ 375 Bhn or ≤ 40 HRc		145	RPM	35450	17725	8862	4431	2216	1477	1108	
		(116-174)	Fr	0.00019	0.0004	0.0007	0.0015	0.0030	0.0045	0.0060	
			Feed (ipm)	6.6	6.6	6.6	6.6	6.6	6.6	6.6	
≤ 450 Bhn or ≤ 48 HRc		60	RPM	14669	7334	3667	1834	917	611	458	
		(48-72)	Fr	0.00008	0.0002	0.0003	0.0007	0.0013	0.0020	0.0026	
			Feed (ipm)	1.2	1.2	1.2	1.2	1.2	1.2	1.2	
K STAINLESS STEELS (FREE MACHINING) 303, 416, 420F, 430F 440F		≤ 250 Bhn or ≤ 24 HRc	210	RPM	51341	25670	12835	6418	3209	2139	1604
			(168-252)	Fr	0.00015	0.0003	0.0006	0.0012	0.0024	0.0036	0.0048
				Feed (ipm)	7.7	7.7	7.7	7.7	7.7	7.7	7.7
	≤ 330 Bhn or ≤ 36 HRc	110	RPM	26893	13446	6723	3362	1681	1121	840	
		(88-132)	Fr	0.00009	0.0002	0.0004	0.0007	0.0015	0.0022	0.0030	
			Feed (ipm)	2.5	2.5	2.5	2.5	2.5	2.5	2.5	
K STAINLESS STEELS (DIFFICULT) 304, 316, 321, 13-8 PH, 15-5PH, 17-4 PH, Custom 450	≤ 275 Bhn or ≤ 28 HRc	65	RPM	15891	7946	3973	1986	993	662	497	
		(52-78)	Fr	0.00010	0.0002	0.0005	0.0009	0.0018	0.0025	0.0035	
			Feed (ipm)	1.7	1.7	1.7	1.7	1.7	1.7	1.7	
	≤ 375 Bhn or ≤ 40 HRc	55	RPM	13446	6723	3362	1681	840	560	420	
		(44-66)	Fr	0.00010	0.0002	0.0004	0.0008	0.0015	0.0023	0.0031	
			Feed (ipm)	1.3	1.3	1.3	1.3	1.3	1.3	1.3	
K CAST IRONS Gray, Malleable, Ductile	≤ 220 Bhn or ≤ 19 HRc	280	RPM	68454	34227	17114	8557	4278	2852	2139	
		(224-336)	Fr	0.00026	0.0005	0.0010	0.0020	0.0041	0.0061	0.0082	
			Feed (ipm)	17.5	17.5	17.5	17.5	17.5	17.5	17.5	
	≤ 330 Bhn or ≤ 36 HRc	250	RPM	61120	30560	15280	7640	3820	2547	1910	
		(200-300)	Fr	0.00025	0.0005	0.0010	0.0020	0.0041	0.0061	0.0081	
			Feed (ipm)	15.5	15.5	15.5	15.5	15.5	15.5	15.5	

continued on next page

FRACTIONAL 2 Flute Drills

Series 101 Fractional	Hardness	Vc (sfm)	DC • in								
			1/64	1/32	1/16	1/8	1/4	3/8	1/2		
N ALUMINUM ALLOYS 2017, 2024, 356, 6061, 7075	≤ 80 Bhn or ≤ 47 HRb	540	RPM	132019	66010	33005	16502	8251	5501	4126	
		(432-648)	Fr	0.00030	0.0006	0.0012	0.0024	0.0048	0.0073	0.0097	
			Feed (ipm)	40.0	40.0	40.0	40.0	40.0	40.0	40.0	
	≤ 150 Bhn or ≤ 7 HRc	455	RPM	111238	55619	27810	13905	6952	4635	3476	
		(364-546)	Fr	0.00031	0.0006	0.0013	0.0025	0.0050	0.0076	0.0101	
			Feed (ipm)	35.0	35.0	35.0	35.0	35.0	35.0	35.0	
	COPPER ALLOYS Alum Bronze, C110, Muntz Brass	≤ 140 Bhn or ≤ 3 HRc	190	RPM	46451	23226	11613	5806	2903	1935	1452
			(152-228)	Fr	0.00015	0.0003	0.0006	0.0012	0.0024	0.0036	0.0048
				Feed (ipm)	7.0	7.0	7.0	7.0	7.0	7.0	7.0
		≤ 200 Bhn or ≤ 23 HRc	175	RPM	42784	21392	10696	5348	2674	1783	1337
			(140-210)	Fr	0.00015	0.0003	0.0006	0.0012	0.0024	0.0036	0.0048
				Feed (ipm)	6.4	6.4	6.4	6.4	6.4	6.4	6.4
PLASTICS Polycarbonate, PVC	500 (400-600)	RPM	122240	61120	30560	15280	7640	5093	3820		
		Fr	0.00031	0.0006	0.0012	0.0025	0.0050	0.0075	0.0099		
		Feed (ipm)	38.0	38.0	38.0	38.0	38.0	38.0	38.0		
S SUPER ALLOYS (NICKEL, COBALT, IRON BASE) Inconel 601, 617, 625, Incoloy 800, Monel 400, Rene, Waspaloy	≤ 220 Bhn or ≤ 19 HRc	40	RPM	9779	4890	2445	1222	611	407	306	
		(32-48)	Fr	0.00010	0.0002	0.0004	0.0008	0.0016	0.0025	0.0033	
			Feed (ipm)	1.0	1.0	1.0	1.0	1.0	1.0	1.0	
	≤ 320 Bhn or ≤ 34 HRc	25	RPM	6112	3056	1528	764	382	255	191	
		(20-30)	Fr	0.00010	0.0002	0.0004	0.0008	0.0016	0.0024	0.0031	
			Feed (ipm)	0.6	0.6	0.6	0.6	0.6	0.6	0.6	
	≤ 425 Bhn or ≤ 45 HRc	20	RPM	4890	2445	1222	611	306	204	153	
		(16-24)	Fr	0.00004	0.0001	0.0002	0.0003	0.0007	0.0010	0.0013	
			Feed (ipm)	0.2	0.2	0.2	0.2	0.2	0.2	0.2	
	TITANIUM ALLOYS (DIFFICULT) Pure Titanium, Ti6Al4V, Ti6Al2Sn4Zr2Mo, Ti4Al4Mo2Sn0.5Si, Ti-6Al4V	≤ 275 Bhn or ≤ 28 HRc	85	RPM	20781	10390	5195	2598	1299	866	649
			(68-102)	Fr	0.00020	0.0004	0.0008	0.0016	0.0032	0.0049	0.0065
				Feed (ipm)	4.2	4.2	4.2	4.2	4.2	4.2	4.2
≤ 350 Bhn or ≤ 38 HRc		65	RPM	15891	7946	3973	1986	993	662	497	
		(52-78)	Fr	0.00011	0.0002	0.0004	0.0009	0.0017	0.0026	0.0034	
			Feed (ipm)	1.7	1.7	1.7	1.7	1.7	1.7	1.7	
≤ 440 Bhn or ≤ 47 HRc	55	RPM	13446	6723	3362	1681	840	560	420		
	(44-66)	Fr	0.00010	0.0002	0.0004	0.0008	0.0015	0.0023	0.0031		
		Feed (ipm)	1.3	1.3	1.3	1.3	1.3	1.3	1.3		
H TOOL STEELS A2, D2, H13, L2, M2, P20, S7, T15, W2	≤ 250 Bhn or ≤ 24 HRc	85	RPM	20781	10390	5195	2598	1299	866	649	
		(68-102)	Fr	0.00011	0.0002	0.0004	0.0009	0.0018	0.0027	0.0035	
			Feed (ipm)	2.3	2.3	2.3	2.3	2.3	2.3	2.3	
	≤ 375 Bhn or ≤ 40 HRc	55	RPM	13446	6723	3362	1681	840	560	420	
		(44-66)	Fr	0.00005	0.0001	0.0002	0.0004	0.0008	0.0012	0.0017	
			Feed (ipm)	0.7	0.7	0.7	0.7	0.7	0.7	0.7	
	≤ 475 Bhn or ≤ 50 HRc	40	RPM	9779	4890	2445	1222	611	407	306	
		(32-48)	Fr	0.00005	0.0001	0.0002	0.0004	0.0008	0.0012	0.0016	
			Feed (ipm)	0.5	0.5	0.5	0.5	0.5	0.5	0.5	

Bhn (Brinell) HRc (Rockwell C) HRb (Rockwell B)

rpm = Vc x 3.82 / DC

ipm = Fr x rpm

reduce speed and feed 30 percent when using uncoated drills

reduce speed and feed for materials harder than listed

refer to the SGS Tool Wizard® for complete technical information (www.kyocera-sgstoool.com)

2 Flute Drills

Short Length Self Centering Drills • DIN 6539

Series 101M, 108M Metric	Hardness	Vc (m/min)	DC • mm								
			1	3	6	8	10	12	16		
P CARBON STEELS 1018, 1040, 1080, 1090, 10L50, 1140, 1212, 12L15, 1525, 1536	≤ 175 Bhn or ≤ 7 HRc	81	RPM	25690	8563	4282	3211	2569	2141	1606	
		(65-97)	Fr	0.014	0.041	0.082	0.109	0.136	0.163	0.218	
			Feed (mm/min)	350	350	350	350	350	350	350	
	≤ 300 Bhn or ≤ 32 HRc	38	RPM	12118	4039	2020	1515	1212	1010	757	
		(30-46)	Fr	0.012	0.036	0.072	0.096	0.120	0.144	0.191	
			Feed (mm/min)	145	145	145	145	145	145	145	
	≤ 425 Bhn or ≤ 45 HRc	26	RPM	8240	2747	1373	1030	824	687	515	
		(21-31)	Fr	0.007	0.020	0.040	0.053	0.067	0.080	0.107	
			Feed (mm/min)	55	55	55	55	55	55	55	
	M ALLOY STEELS 4140, 4150, 4320, 5120, 5150, 8630, 86L20, 50100	≤ 275 Bhn or ≤ 28 HRc	70	RPM	22297	7432	3716	2787	2230	1858	1394
			(56-84)	Fr	0.012	0.036	0.073	0.097	0.121	0.145	0.194
				Feed (mm/min)	270	270	270	270	270	270	270
≤ 375 Bhn or ≤ 40 HRc		44	RPM	14057	4686	2343	1757	1406	1171	879	
		(35-53)	Fr	0.012	0.036	0.073	0.097	0.121	0.145	0.194	
			Feed (mm/min)	170	170	170	170	170	170	170	
≤ 450 Bhn or ≤ 48 HRc		18	RPM	5816	1939	969	727	582	485	364	
		(15-22)	Fr	0.005	0.015	0.030	0.040	0.050	0.060	0.080	
			Feed (mm/min)	29	29	29	29	29	29	29	
K STAINLESS STEELS (FREE MACHINING) 303, 416, 420F, 430F 440F		≤ 250 Bhn or ≤ 24 HRc	64	RPM	20358	6786	3393	2545	2036	1696	1272
			(51-77)	Fr	0.010	0.029	0.059	0.079	0.098	0.118	0.157
				Feed (mm/min)	200	200	200	200	200	200	200
	≤ 330 Bhn or ≤ 36 HRc	34	RPM	10664	3555	1777	1333	1066	889	666	
		(27-40)	Fr	0.006	0.017	0.034	0.045	0.056	0.068	0.090	
			Feed (mm/min)	60	60	60	60	60	60	60	
	K STAINLESS STEELS (DIFFICULT) 304, 316, 321, 13-8 PH, 15-5PH, 17-4 PH, Custom 450	≤ 275 Bhn or ≤ 28 HRc	20	RPM	6301	2100	1050	788	630	525	394
			(16-24)	Fr	0.007	0.021	0.043	0.057	0.071	0.086	0.114
				Feed (mm/min)	45	45	45	45	45	45	45
		≤ 375 Bhn or ≤ 40 HRc	17	RPM	5332	1777	889	666	533	444	333
			(13-20)	Fr	0.007	0.020	0.039	0.053	0.066	0.079	0.105
				Feed (mm/min)	35	35	35	35	35	35	35
K CAST IRONS Gray, Malleable, Ductile		≤ 220 Bhn or ≤ 19 HRc	85	RPM	27144	9048	4524	3393	2714	2262	1696
			(68-102)	Fr	0.016	0.049	0.097	0.130	0.162	0.195	0.259
				Feed (mm/min)	440	440	440	440	440	440	440
		≤ 330 Bhn or ≤ 36 HRc	76	RPM	24235	8078	4039	3029	2424	2020	1515
			(61-91)	Fr	0.017	0.050	0.099	0.132	0.165	0.198	0.264
				Feed (mm/min)	400	400	400	400	400	400	400

continued on next page

2 Flute Drills

Short Length Self Centering Drills • DIN 6539

Series 101M, 108M Metric	Hardness	Vc (m/min)	DC • mm								
			1	3	6	8	10	12	16		
N ALUMINUM ALLOYS 2017, 2024, 356, 6061, 7075	≤ 80 Bhn or ≤ 47 HRb	165 (132-198)	RPM	52348	17449	8725	6544	5235	4362	3272	
			Fr	0.020	0.060	0.120	0.160	0.200	0.240	0.319	
			Feed (mm/min)	1045	1045	1045	1045	1045	1045	1045	
	≤ 150 Bhn or ≤ 7 HRc	139 (111-166)	RPM	44108	14703	7351	5514	4411	3676	2757	
			Fr	0.020	0.060	0.120	0.160	0.200	0.239	0.319	
			Feed (mm/min)	880	880	880	880	880	880	880	
	COPPER ALLOYS Alum Bronze, C110, Muntz Brass	≤ 140 Bhn or ≤ 3 HRc	58 (46-69)	RPM	18419	6140	3070	2302	1842	1535	1151
				Fr	0.010	0.030	0.060	0.080	0.100	0.121	0.161
				Feed (mm/min)	185	185	185	185	185	185	185
		≤ 200 Bhn or ≤ 23 HRc	53 (43-64)	RPM	16965	5655	2827	2121	1696	1414	1060
				Fr	0.010	0.030	0.060	0.080	0.100	0.120	0.160
				Feed (mm/min)	170	170	170	170	170	170	170
PLASTICS Polycarbonate, PVC	152 (122-183)	RPM	48471	16157	8078	6059	4847	4039	3029		
		Fr	0.020	0.060	0.120	0.160	0.200	0.240	0.320		
		Feed (mm/min)	970	970	970	970	970	970	970		
S SUPER ALLOYS (NICKEL, COBALT, IRON BASE) Inconel 601, 617, 625, Incoloy 800, Monel 400, Rene, Waspaloy	≤ 220 Bhn or ≤ 19 HRc	12 (10-15)	RPM	3878	1293	646	485	388	323	242	
			Fr	0.006	0.019	0.039	0.052	0.064	0.077	0.103	
			Feed (mm/min)	25	25	25	25	25	25	25	
	≤ 320 Bhn or ≤ 34 HRc	8 (6-9)	RPM	2424	808	404	303	242	202	151	
			Fr	0.006	0.019	0.037	0.050	0.062	0.074	0.099	
			Feed (mm/min)	15	15	15	15	15	15	15	
	≤ 425 Bhn or ≤ 45 HRc	6 (5-7)	RPM	1939	646	323	242	194	162	121	
			Fr	0.005	0.015	0.031	0.041	0.052	0.062	0.083	
			Feed (mm/min)	10	10	10	10	10	10	10	
	S TITANIUM ALLOYS (DIFFICULT) Pure Titanium, Ti6Al4V, Ti6Al2Sn4Zr2Mo, Ti4Al4Mo2Sn0.5Si, Ti-6Al4V	≤ 275 Bhn or ≤ 28 HRc	26 (21-31)	RPM	8240	2747	1373	1030	824	687	515
				Fr	0.013	0.040	0.080	0.107	0.133	0.160	0.214
				Feed (mm/min)	110	110	110	110	110	110	110
≤ 350 Bhn or ≤ 38 HRc		20 (16-24)	RPM	6301	2100	1050	788	630	525	394	
			Fr	0.007	0.021	0.043	0.057	0.071	0.086	0.114	
			Feed (mm/min)	45	45	45	45	45	45	45	
≤ 440 Bhn or ≤ 47 HRc	17 (13-20)	RPM	5332	1777	889	666	533	444	333		
		Fr	0.007	0.020	0.039	0.053	0.066	0.079	0.105		
		Feed (mm/min)	35	35	35	35	35	35	35		
H TOOL STEELS A2, D2, H13, L2, M2, P20, S7, T15, W2	≤ 250 Bhn or ≤ 24 HRc	26 (21-31)	RPM	8240	2747	1373	1030	824	687	515	
			Fr	0.007	0.020	0.040	0.053	0.067	0.080	0.107	
			Feed (mm/min)	55	55	55	55	55	55	55	
	≤ 375 Bhn or ≤ 40 HRc	17 (13-20)	RPM	5332	1777	889	666	533	444	333	
			Fr	0.003	0.010	0.020	0.027	0.034	0.041	0.054	
			Feed (mm/min)	18	18	18	18	18	18	18	
	≤ 475 Bhn or ≤ 50 HRc	12 (10-15)	RPM	3878	1293	646	485	388	323	242	
			Fr	0.003	0.009	0.019	0.025	0.031	0.037	0.050	
			Feed (mm/min)	12	12	12	12	12	12	12	

Bhn (Brinell) HRc (Rockwell C) HRb (Rockwell B)
 rpm = (Vc x 1000) / (DC x 3.14)
 mm/min = Fr x rpm
 reduce speed and feed 30 percent when using uncoated drills
 reduce speed and feed for materials harder than listed
 refer to the SGS Tool Wizard® for complete technical information (www.kyocera-sgstool.com)

Straight Flute Drills • Metric: DIN 6539



3xD



106

FRACTIONAL & METRIC SERIES

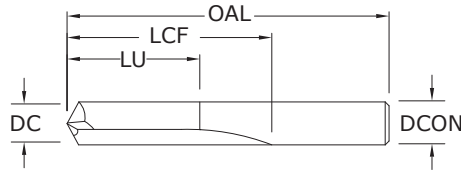

CUTTING DIAMETER DC / DCON	DECIMAL EQUIV.	METRIC EQUIV.	OVERALL LENGTH OAL	FLUTE LENGTH LCF	CLEARED LENGTH LU	EDP NO.	
						UNCOATED	Ti-NAMITE-A (AITiN)
1,0 mm	0.0394		26,0	6,0	4,5	66001	66002
#60	0.0400	1.02	1-1/2	1/2	13/32	56060	56269
#59	0.0410	1.04	1-1/2	1/2	13/32	56059	56268
#58	0.0420	1.07	1-1/2	1/2	13/32	56058	56267
#57	0.0430	1.09	1-1/2	1/2	13/32	56057	56266
#56	0.0465	1.18	1-1/2	1/2	13/32	56056	56265
3/64	0.0469	1.19	1-1/2	1/2	13/32	56103	56135
#55	0.0520	1.32	1-1/2	1/2	13/32	56055	56264
#54	0.0550	1.40	1-1/2	1/2	13/32	56054	56263
1,5 mm	0.0591		32,0	9,0	7,0	66003	66004
#53	0.0595	1.51	1-1/2	1/2	13/32	56053	56262
1/16	0.0625	1.59	1-1/2	5/8	1/2	56104	56136
#52	0.0635	1.61	1-11/16	11/16	35/64	56052	56261
#51	0.0670	1.70	1-11/16	11/16	35/64	56051	56260
#50	0.0700	1.78	1-11/16	11/16	35/64	56050	56259
#49	0.0730	1.85	1-11/16	11/16	35/64	56049	56258
#48	0.0760	1.93	1-11/16	11/16	35/64	56048	56257
5/64	0.0781	1.98	1-11/16	11/16	35/64	56105	56137
#47	0.0785	1.99	1-3/4	3/4	39/64	56047	56256
2,0 mm	0.0787		38,0	12,0	9,0	66005	66006
#46	0.0810	2.06	1-3/4	3/4	39/64	56046	56255
#45	0.0820	2.08	1-3/4	3/4	39/64	56045	56254
#44	0.0860	2.18	1-3/4	3/4	39/64	56044	56253
#43	0.0890	2.26	1-3/4	3/4	39/64	56043	56252
#42	0.0935	2.37	1-3/4	3/4	39/64	56042	56251
3/32	0.0938	2.38	1-3/4	3/4	39/64	56106	56138
#41	0.0960	2.44	1-13/16	13/16	21/32	56041	56250
#40	0.0980	2.49	1-13/16	13/16	21/32	56040	56249
2,5 mm	0.0984		43,0	14,0	11,0	66007	66008
#39	0.0995	2.53	1-13/16	13/16	21/32	56039	56248
#38	0.1015	2.58	1-13/16	13/16	21/32	56038	56247
#37	0.1040	2.64	1-13/16	13/16	21/32	56037	56246
#36	0.1065	2.71	1-13/16	13/16	21/32	56036	56245
7/64	0.1094	2.78	1-13/16	13/16	21/32	56107	56139
#35	0.1100	2.79	1-7/8	7/8	45/64	56035	56244
#34	0.1110	2.82	1-7/8	7/8	45/64	56034	56243

TOLERANCES (inch)

DC = +0.0000/-0.0005
DCON = h₆

TOLERANCES (mm)

DC = +0.0000/-0.0127
DCON = h₆

- STEELS
- CAST IRON
- HARDENED STEELS

For patent information visit www.kspatents.com

continued on next page

Straight Flute Drills • Metric: DIN 6539

106

FRACTIONAL & METRIC SERIES

CONTINUED

CUTTING DIAMETER DC/DCON	DECIMAL EQUIV.	METRIC EQUIV.	OVERALL LENGTH OAL	FLUTE LENGTH LCF	CLEARED LENGTH LU	EDP NO.	
						UNCOATED	Ti-NAMITE-A (AITiN)
#33	0.1130	2.87	1-7/8	7/8	45/64	56033	56242
#32	0.1160	2.95	1-7/8	7/8	45/64	56032	56241
3,0 mm	0.1181		46,0	16,0	12,0	66009	66010
#31	0.1200	3.05	1-7/8	7/8	45/64	56031	56240
1/8	0.1250	3.18	1-7/8	7/8	45/64	56108	56140
#30	0.1285	3.26	1-15/16	15/16	3/4	56030	56239
#29	0.1360	3.45	1-15/16	15/16	3/4	56029	56238
3,5 mm	0.1378		52,0	20,0	15,0	66011	66012
#28	0.1405	3.57	1-15/16	15/16	3/4	56028	56237
9/64	0.1406	3.57	1-15/16	15/16	3/4	56109	56141
#27	0.1440	3.66	2-1/16	1	51/64	56027	56236
#26	0.1470	3.73	2-1/16	1	51/64	56026	56235
#25	0.1495	3.80	2-1/16	1	51/64	56025	56234
#24	0.1520	3.86	2-1/16	1	51/64	56024	56233
#23	0.1540	3.91	2-1/16	1	51/64	56023	56232
5/32	0.1562	3.97	2-1/16	1	51/64	56110	56142
#22	0.1570	3.99	2-1/8	1-1/16	55/64	56022	56231
4,0 mm	0.1575		55,0	22,0	17,0	66013	66014
#21	0.1590	4.04	2-1/8	1-1/16	55/64	56021	56230
#20	0.1610	4.09	2-1/8	1-1/16	55/64	56020	56229
#19	0.1660	4.22	2-1/8	1-1/16	55/64	56019	56228
#18	0.1695	4.31	2-1/8	1-1/16	55/64	56018	56227
11/64	0.1719	4.37	2-1/8	1-1/16	55/64	56111	56143
#17	0.1730	4.39	2-3/16	1-1/8	29/32	56017	56226
#16	0.1770	4.50	2-3/16	1-1/8	29/32	56016	56225
4,5 mm	0.1772		58,0	24,0	18,0	66015	66016
#15	0.1800	4.57	2-3/16	1-1/8	29/32	56015	56224
#14	0.1820	4.62	2-3/16	1-1/8	29/32	56014	56223
#13	0.1850	4.70	2-3/16	1-1/8	29/32	56013	56222
3/16	0.1875	4.76	2-3/16	1-1/8	29/32	56112	56144
#12	0.1890	4.80	2-3/16	1-1/8	29/32	56012	56221
#11	0.1910	4.85	2-3/16	1-1/8	29/32	56011	56220
#10	0.1935	4.91	2-3/16	1-1/8	29/32	56010	56219
#9	0.1960	4.98	2-1/4	1-3/16	61/64	56009	56218
5,0 mm	0.1969		62,0	26,0	20,0	66017	66018
#8	0.1990	5.05	2-1/4	1-3/16	61/64	56008	56217
#7	0.2010	5.11	2-1/4	1-3/16	61/64	56007	56216
13/64	0.2031	5.16	2-1/4	1-3/16	61/64	56113	56145
#6	0.2040	5.18	2-3/8	1-1/4	1	56006	56215
#5	0.2055	5.22	2-3/8	1-1/4	1	56005	56214
#4	0.2090	5.31	2-3/8	1-1/4	1	56004	56213
#3	0.2130	5.41	2-3/8	1-1/4	1	56003	56212
5,5 mm	0.2165		66,0	28,0	21,0	66019	66020
7/32	0.2188	5.56	2-3/8	1-1/4	1	56114	56146
#2	0.2210	5.61	2-7/16	1-5/16	1-3/64	56002	56211
#1	0.2280	5.79	2-7/16	1-5/16	1-3/64	56001	56210

continued on next page

Straight Flute Drills • Metric: DIN 6539



3xD



106

FRACTIONAL & METRIC SERIES

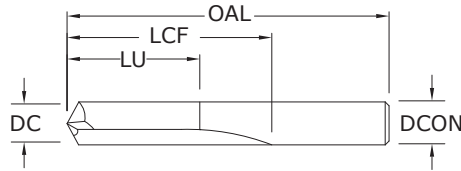

CUTTING DIAMETER DC / DCON	DECIMAL EQUIV.	METRIC EQUIV.	OVERALL LENGTH OAL	FLUTE LENGTH LCF	CLEARED LENGTH LU	EDP NO.	
						UNCOATED	Ti-NAMITE-A (AITIN)
15/64	0.2344	5.95	2-7/16	1-5/16	1-3/64	56115	56147
6,0 mm	0.2362		66,0	28,0	21,0	66021	66045
1/4	0.2500	6.35	2-1/2	1-3/8	1-7/64	56116	56148
6,5 mm	0.2559		70,0	31,0	23,0	66022	66046
17/64	0.2656	6.75	2-5/8	1-7/16	1-7/64	56117	56149
7,0 mm	0.2756		74,0	34,0	25,0	66023	66024
9/32	0.2812	7.14	2-11/16	1-1/2	1-13/64	56118	56150
7,5 mm	0.2953		74,0	34,0	25,0	66025	66026
19/64	0.2969	7.54	2-3/4	1-9/16	1-1/4	56119	56151
5/16	0.3125	7.94	2-13/16	1-5/8	1-19/64	56120	56152
8,0 mm	0.3150		79,0	37,0	27,0	66027	66028
21/64	0.3281	8.33	2-15/16	1-11/16	1-23/64	56121	56153
8,5 mm	0.3346		79,0	37,0	27,0	66029	66030
11/32	0.3438	8.73	3	1-11/16	1-23/64	56122	56154
9,0 mm	0.3543		84,0	40,0	29,0	66031	66032
23/64	0.3594	9.13	3-1/16	1-3/4	1-13/32	56123	56155
9,5 mm	0.3740		84,0	40,0	29,0	66033	66034
3/8	0.3750	9.53	3-1/8	1-13/16	1-29/64	56124	56156
25/64	0.3906	9.92	3-1/4	1-7/8	1-1/2	56125	56157
10,0 mm	0.3937		89,0	43,0	31,0	66035	66036
13/32	0.4062	10.32	3-5/16	1-15/16	1-35/64	56126	56158
10,5 mm	0.4134		89,0	43,0	31,0	66037	66038
27/64	0.4219	10.72	3-3/8	2	1-39/64	56127	56159
11,0 mm	0.4331		95,0	47,0	33,0	66039	66040
7/16	0.4375	11.11	3-7/16	2-1/16	1-21/32	56128	56160
11,5 mm	0.4528		95,0	47,0	33,0	66041	66042
29/64	0.4531	11.51	3-9/16	2-1/8	1-45/64	56129	56161
15/32	0.4688	11.91	3-5/8	2-1/8	1-45/64	56130	56162
12,0 mm	0.4724		102,0	51,0	35,0	66043	66044
31/64	0.4844	12.30	3-11/16	2-3/16	1-3/4	56131	56163
1/2	0.5000	12.70	3-3/4	2-1/4	1-51/64	56132	56164

TOLERANCES (inch)

DC = +0.0000/-0.0005
DCON = h₆

TOLERANCES (mm)

DC = +0.0000/-0.0127
DCON = h₆

STEELS

CAST IRON

HARDENED STEELS

For patent information visit www.ksptpatents.com

FRACTIONAL & METRIC
Straight Flute Drills

Series 106 Fractional	Hardness	Vc (sfm)	DC • in						
			1/16	1/8	3/16	1/4	3/8	1/2	
P ALLOY STEELS 4140, 4150, 4320, 5120, 5150, 8630, 86L20, 50100	≤ 500 Bhn or ≤ 52 HRc	60	RPM	3667	1834	1222	917	611	458
		(48-72)	Fr	0.0004	0.0007	0.0011	0.0014	0.0021	0.0028
			Feed (ipm)	1.3	1.3	1.3	1.3	1.3	1.3
	≤ 615 Bhn or ≤ 58 HRc	50	RPM	3056	1528	1019	764	509	382
		(40-60)	Fr	0.0004	0.0008	0.0012	0.0016	0.0024	0.0031
			Feed (ipm)	1.2	1.2	1.2	1.2	1.2	1.2
K CAST IRONS Gray, Malleable, Ductile	≤ 220 Bhn or ≤ 19 HRc	250	RPM	15280	7640	5093	3820	2547	1910
		(200-300)	Fr	0.0010	0.0020	0.0030	0.0041	0.0061	0.0081
			Feed (ipm)	15.5	15.5	15.5	15.5	15.5	15.5
	≤ 330 Bhn or ≤ 36 HRc	195	RPM	11918	5959	3973	2980	1986	1490
		(156-234)	Fr	0.0010	0.0020	0.0030	0.0040	0.0060	0.0081
			Feed (ipm)	12.0	12.0	12.0	12.0	12.0	12.0
H TOOL STEELS A2, D2, H13, L2, M2, P20, S7, T15, W2	≤ 500 Bhn or ≤ 52 HRc	60	RPM	3667	1834	1222	917	611	458
		(48-72)	Fr	0.0004	0.0007	0.0011	0.0014	0.0021	0.0028
			Feed (ipm)	1.3	1.3	1.3	1.3	1.3	1.3
	≤ 615 Bhn or ≤ 58 HRc	50	RPM	3056	1528	1019	764	509	382
		(40-60)	Fr	0.0004	0.0008	0.0012	0.0016	0.0024	0.0031
			Feed (ipm)	1.2	1.2	1.2	1.2	1.2	1.2

Bhn (Brinell) HRc (Rockwell C)
 $rpm = Vc \times 3.82 / DC$
 $ipm = Fr \times rpm$
 reduce speed and feed 30 percent when using uncoated drills
 refer to the SGS Tool Wizard® for complete technical information (www.kyocera-sgtool.com)

Series 106M Metric	Hardness	Vc (m/min)	DC • mm						
			1	3	6	8	10	12	
P ALLOY STEELS 4140, 4150, 4320, 5120, 5150, 8630, 86L20, 50100	≤ 500 Bhn or ≤ 52 HRc	18	RPM	5816	1939	969	727	582	485
		(15-22)	Fr	0.006	0.018	0.035	0.047	0.058	0.070
			Feed (mm/min)	34	34	34	34	34	34
	≤ 615 Bhn or ≤ 58 HRc	15	RPM	4847	1616	808	606	485	404
		(12-18)	Fr	0.006	0.017	0.033	0.045	0.056	0.067
			Feed (mm/min)	27	27	27	27	27	27
K CAST IRONS Gray, Malleable, Ductile	≤ 220 Bhn or ≤ 19 HRc	76	RPM	24235	8078	4039	3029	2424	2020
		(61-91)	Fr	0.016	0.048	0.096	0.128	0.160	0.192
			Feed (mm/min)	395	395	395	395	395	395
	≤ 330 Bhn or ≤ 36 HRc	59	RPM	18904	6301	3151	2363	1890	1575
		(48-71)	Fr	0.016	0.048	0.096	0.128	0.160	0.192
			Feed (mm/min)	305	305	305	305	305	305
H TOOL STEELS A2, D2, H13, L2, M2, P20, S7, T15, W2	≤ 500 Bhn or ≤ 52 HRc	18	RPM	5816	1939	969	727	582	485
		(15-22)	Fr	0.006	0.018	0.035	0.047	0.058	0.070
			Feed (mm/min)	34	34	34	34	34	34
	≤ 615 Bhn or ≤ 58 HRc	15	RPM	4847	1616	808	606	485	404
		(12-18)	Fr	0.006	0.017	0.033	0.045	0.056	0.067
			Feed (mm/min)	27	27	27	27	27	27

Bhn (Brinell) HRc (Rockwell C)
 $rpm = (Vc \times 1000) / (DC \times 3.14)$
 $mm/min = Fr \times rpm$
 reduce speed and feed 30 percent when using uncoated drills
 refer to the SGS Tool Wizard® for complete technical information (www.kyocera-sgtool.com)

3 Flute Drills • Metric: DIN 6539



3xD
(mm)

5xD
(inch)

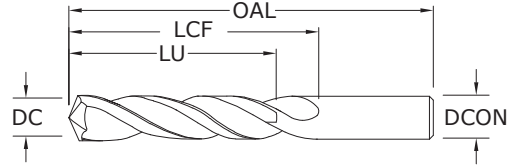

103

FRACTIONAL & METRIC SERIES

CUTTING DIAMETER DC / DCON	DECIMAL EQUIV.	METRIC EQUIV.	OVERALL LENGTH OAL	FLUTE LENGTH LCF	CLEARED LENGTH LU	EDP NO.	
						UNCOATED	Ti-NAMITE-A (AITiN)
#36	0.1065	2.71	2-1/4	1-1/4	1	53036	58011
7/64	0.1094	2.78	2-1/4	1-1/4	1	53107	58012
#35	0.1100	2.79	2-1/4	1-1/4	1	53035	58013
#34	0.1110	2.82	2-1/4	1-1/4	1	53034	58014
#33	0.1130	2.87	2-1/4	1-1/4	1	53033	58015
#32	0.1160	2.95	2-1/4	1-1/4	1	53032	58016
3,0 mm	0.1181		46,0	16,0	12,0	63000	68965
#31	0.1200	3.05	2-1/4	1-1/4	1	53031	58017
3,1 mm	0.1220		49,0	18,0	14,0	63044	68966
1/8	0.1250	3.18	2-1/4	1-1/4	1	53108	58018
3,2 mm	0.1260		49,0	18,0	14,0	63045	68967
#30	0.1285	3.26	2-1/4	1-1/4	1	53030	58019
3,3 mm	0.1299		49,0	18,0	14,0	63001	68968
3,4 mm	0.1339		52,0	20,0	15,0	63046	68969
#29	0.1360	3.45	2-1/2	1-3/8	1-7/64	53029	58020
3,5 mm	0.1378		52,0	20,0	15,0	63002	68970
#28	0.1405	3.57	2-1/2	1-3/8	1-7/64	53028	58021
9/64	0.1406	3.57	2-1/2	1-3/8	1-7/64	53109	58022
3,6 mm	0.1417		52,0	20,0	15,0	63047	68971
#27	0.1440	3.66	2-1/2	1-3/8	1-7/64	53027	58023
3,7 mm	0.1457		52,0	20,0	15,0	63003	68972
#26	0.1470	3.73	2-1/2	1-3/8	1-7/64	53026	58024
#25	0.1495	3.80	2-1/2	1-3/8	1-7/64	53025	58025
3,8 mm	0.1496		55,0	22,0	17,0	63048	68973
#24	0.1520	3.86	2-1/2	1-3/8	1-7/64	53024	58026
3,9 mm	0.1535		55,0	22,0	17,0	63049	68974
#23	0.1540	3.91	2-1/2	1-3/8	1-7/64	53023	58027
5/32	0.1562	3.97	2-1/2	1-3/8	1-7/64	53110	58028
#22	0.1570	3.99	2-1/2	1-3/8	1-7/64	53022	58029
4,0 mm	0.1575		55,0	22,0	17,0	63004	68975
#21	0.1590	4.04	2-1/2	1-3/8	1-7/64	53021	58030
#20	0.1610	4.09	2-1/2	1-3/8	1-7/64	53020	58031
4,1 mm	0.1614		55,0	22,0	17,0	63050	68976
4,2 mm	0.1654		55,0	22,0	17,0	63005	68977
#19	0.1660	4.22	2-3/4	1-5/8	1-19/64	53019	58032
4,3 mm	0.1693		58,0	24,0	18,0	63051	68978
#18	0.1695	4.31	2-3/4	1-5/8	1-19/64	53018	58033
11/64	0.1719	4.37	2-3/4	1-5/8	1-19/64	53111	58034
#17	0.1730	4.39	2-3/4	1-5/8	1-19/64	53017	58035
4,4 mm	0.1732		58,0	24,0	18,0	63052	68979

TOLERANCES (inch)

DC = +0.0000/-0.0005
DCON = h₆

TOLERANCES (mm)

DC = +0.0000/-0.0127
DCON = h₆

- STEELS
- CAST IRON
- HARDENED STEELS
- NON-FERROUS

For patent information visit www.ksptpatents.com

continued on next page

3 Flute Drills • Metric: DIN 6539

103

FRACTIONAL & METRIC SERIES

CONTINUED

CUTTING DIAMETER DC/DCON	DECIMAL EQUIV.	METRIC EQUIV.	OVERALL LENGTH OAL	FLUTE LENGTH LCF	CLEARED LENGTH LU	EDP NO.	
						UNCOATED	Ti-NAMITE-A (AITiN)
#16	0.1770	4.50	2-3/4	1-5/8	1-19/64	53016	58036
4,5 mm	0.1772		58,0	24,0	18,0	63006	68980
#15	0.1800	4.57	2-3/4	1-5/18	1-19/64	53015	58037
4,6 mm	0.1811		58,0	24,0	18,0	63053	68981
#14	0.1820	4.62	2-3/4	1-5/8	1-19/64	53014	58038
#13	0.1850	4.70	2-3/4	1-5/8	1-19/64	53013	58039
4,7 mm	0.1850		58,0	24,0	18,0	63054	68982
3/16	0.1875	4.76	2-3/4	1-5/8	1-19/64	53112	58040
#12	0.1890	4.80	2-3/4	1-5/8	1-19/64	53012	58041
4,8 mm	0.1890		62,0	26,0	20,0	63055	68983
#11	0.1910	4.85	2-3/4	1-5/8	1-19/64	53011	58042
4,9 mm	0.1929		62,0	26,0	20,0	63056	68984
#10	0.1935	4.91	2-3/4	1-5/8	1-19/64	53010	58043
#9	0.1960	4.98	3	1-3/4	1-13/32	53009	58044
5,0 mm	0.1969		62,0	26,0	20,0	63007	68985
#8	0.1990	5.05	3	1-3/4	1-13/32	53008	58045
5,1 mm	0.2008		62,0	26,0	20,0	63057	68986
#7	0.2010	5.11	3	1-3/4	1-13/32	53007	58046
13/64	0.2031	5.16	3	1-3/4	1-13/32	53113	58047
#6	0.2040	5.18	3	1-3/4	1-13/32	53006	58048
5,2 mm	0.2047		62,0	26,0	20,0	63008	68987
#5	0.2055	5.22	3	1-3/4	1-13/32	53005	58049
5,3 mm	0.2087		62,0	26,0	20,0	63058	68988
#4	0.2090	5.31	3	1-3/4	1-13/32	53004	58050
5,4 mm	0.2126		66,0	28,0	21,0	63059	68989
#3	0.2130	5.41	3	1-3/4	1-13/32	53003	58051
5,5 mm	0.2165		66,0	28,0	21,0	63009	68990
7/32	0.2188	5.56	3	1-3/4	1-13/32	53114	58052
5,6 mm	0.2205		66,0	28,0	21,0	63060	68991
#2	0.2210	5.61	3	1-3/4	1-13/32	53002	58053
5,7 mm	0.2244		66,0	28,0	21,0	63061	68992
#1	0.2280	5.79	3	1-3/4	1-13/32	53001	58054
5,8 mm	0.2283		66,0	28,0	21,0	63062	68993
5,9 mm	0.2323		66,0	28,0	21,0	63063	68994
A	0.2340	5.94	3-1/4	2	1-39/64	53201	58055
15/64	0.2344	5.95	3-1/4	2	1-39/64	53115	58056
6,0 mm	0.2362		66,0	28,0	21,0	63010	68995
B	0.2380	6.05	3-1/4	2	1-39/64	53202	58057
6,1 mm	0.2402		70,0	31,0	23,0	63064	68996
C	0.2420	6.15	3-1/4	2	1-39/64	53203	58058
6,2 mm	0.2441		70,0	31,0	23,0	63011	68997
D	0.2460	6.25	3-1/4	2	1-39/64	53204	58059
6,3 mm	0.2480		70,0	31,0	23,0	63065	68998
1/4	0.2500	6.35	3-1/4	2	1-39/64	53116	58061
6,4 mm	0.2520		70,0	31,0	23,0	63066	68999
6,5 mm	0.2559		70,0	31,0	23,0	63012	69000
F	0.2570	6.53	3-1/4	2	1-39/64	53206	58062
6,6 mm	0.2598		70,0	31,0	23,0	63067	69001
G	0.2610	6.63	3-1/2	2-1/8	1-45/64	53207	58063
6,7 mm	0.2638		70,0	31,0	23,0	63068	69002

continued on next page

3 Flute Drills • Metric: DIN 6539



3xD
(mm)

5xD
(inch)

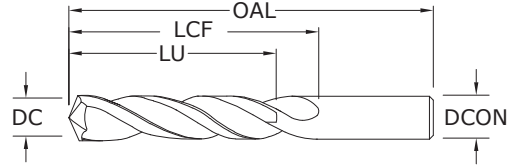

103

FRACTIONAL & METRIC SERIES

CUTTING DIAMETER DC / DCON	DECIMAL EQUIV.	METRIC EQUIV.	OVERALL LENGTH OAL	FLUTE LENGTH LCF	CLEARED LENGTH LU	EDP NO.	
						UNCOATED	Ti-NAMITE-A (AITIN)
17/64	0.2656	6.75	3-1/2	2-1/8	1-45/64	53117	58064
H	0.2660	6.76	3-1/2	2-1/8	1-45/64	53208	58065
6,8 mm	0.2677		74,0	34,0	25,0	63013	69003
6,9 mm	0.2717		74,0	34,0	25,0	63069	69004
I	0.2720	6.91	3-1/2	2-1/8	1-45/64	53209	58066
7,0 mm	0.2756		74,0	34,0	25,0	63014	69005
J	0.2770	7.04	3-1/2	2-1/8	1-45/64	53210	58067
7,1 mm	0.2795		74,0	34,0	25,0	63070	69006
K	0.2810	7.14	3-1/2	2-1/8	1-45/64	53211	58068
9/32	0.2812	7.14	3-1/2	2-1/8	1-45/64	53118	58069
7,2 mm	0.2835		74,0	34,0	25,0	63015	69007
7,3 mm	0.2874		74,0	34,0	25,0	63071	69008
L	0.2900	7.37	3-1/2	2-1/8	1-45/64	53212	58070
7,4 mm	0.2913		74,0	34,0	25,0	63072	69009
M	0.2950	7.49	3-3/4	2-3/8	1-29/32	53213	58071
7,5 mm	0.2953		74,0	34,0	25,0	63016	69010
19/64	0.2969	7.54	3-3/4	2-3/8	1-29/32	53119	58072
7,6 mm	0.2992		79,0	37,0	27,0	63073	69011
N	0.3020	7.67	2-3/8	2-3/8	1-29/32	53214	58073
7,7 mm	0.3031		79,0	37,0	27,0	63074	69012
7,8 mm	0.3071		79,0	37,0	27,0	63075	69013
7,9 mm	0.3110		79,0	37,0	27,0	63076	69014
5/16	0.3125	7.94	3-3/4	2-3/8	1-29/32	53120	58074
8,0 mm	0.3150		79,0	37,0	27,0	63017	69015
O	0.3160	8.03	3-3/4	2-3/8	1-29/32	53215	58075
8,1 mm	0.3189		79,0	37,0	27,0	63077	69016
8,2 mm	0.3228		79,0	37,0	27,0	63018	69017
P	0.3230	8.20	3-3/4	2-3/8	1-29/32	53216	58076
8,3 mm	0.3268		79,0	37,0	27,0	63078	69018
21/64	0.3281	8.33	4	2-1/2	2	53121	58077
8,4 mm	0.3307		79,0	37,0	27,0	63019	69019
Q	0.3320	8.43	4	2-1/2	2	53217	58078
8,5 mm	0.3346		79,0	37,0	27,0	63020	69020
8,6 mm	0.3386		84,0	40,0	29,0	63021	69021
R	0.3390	8.61	4	2-1/2	2	53218	58079
8,7 mm	0.3425		84,0	40,0	29,0	63079	69022
11/32	0.3438	8.73	4	2-1/2	2	53122	58080
8,8 mm	0.3465		84,0	40,0	29,0	63022	69023
S	0.3480	8.84	4	2-1/2	2	53219	58081
8,9 mm	0.3504		84,0	40,0	29,0	63080	69024
9,0 mm	0.3543		84,0	40,0	29,0	63023	69025
T	0.3580	9.09	4-1/4	2-3/4	2-13/64	53220	58082

TOLERANCES (inch)

DC = +0.0000/-0.0005
DCON = h₆

TOLERANCES (mm)

DC = +0,0000/-0,0127
DCON = h₆

- STEELS
- CAST IRON
- HARDENED STEELS
- NON-FERROUS

For patent information visit www.ksptpatents.com

continued on next page

3 Flute Drills • Metric: DIN 6539

103

FRACTIONAL & METRIC SERIES

CONTINUED

CUTTING DIAMETER DC / DCON	DECIMAL EQUIV.	METRIC EQUIV.	OVERALL LENGTH OAL	FLUTE LENGTH LCF	CLEARED LENGTH LU	EDP NO.	
						UNCOATED	Ti-NAMITE-A (AITiN)
9,1 mm	0.3583		84,0	40,0	29,0	63081	69026
23/64	0.3594	9.13	4-1/4	2-3/4	2-13/64	53123	58083
9,2 mm	0.3622		84,0	40,0	29,0	63024	69027
9,3 mm	0.3661		84,0	40,0	29,0	63082	69028
U	0.3680	9.35	4-1/4	2-3/4	2-13/64	53221	58084
9,4 mm	0.3701		84,0	40,0	29,0	63083	69029
9,5 mm	0.3740		84,0	40,0	29,0	63025	69030
3/8	0.3750	9.53	4-1/4	2-3/4	2-13/64	53124	58085
V	0.3770	9.58	4-1/4	2-3/4	2-13/64	53222	58086
9,6 mm	0.3780		89,0	43,0	31,0	63084	69031
9,7 mm	0.3819		89,0	43,0	31,0	63085	69032
9,8 mm	0.3858		89,0	43,0	31,0	63086	69033
W	0.3860	9.80	4-1/2	2-7/8	2-19/64	53223	58087
9,9 mm	0.3898		89,0	43,0	31,0	63087	69034
25/64	0.3906	9.92	4-1/2	2-7/8	2-19/64	53125	58088
10,0 mm	0.3937		89,0	43,0	31,0	63026	69035
X	0.3970	10.08	4-1/2	2-7/8	2-19/64	53224	58089
10,1 mm	0.3976		89,0	43,0	31,0	63088	69036
10,2 mm	0.4016		89,0	43,0	31,0	63027	69037
Y	0.4040	10.26	4-1/2	2-7/8	2-19/64	53225	58090
13/32	0.4062	10.32	4-1/2	2-7/8	2-19/64	53126	58091
10,4 mm	0.4094		89,0	43,0	31,0	63028	69038
Z	0.4130	10.49	4-1/2	2-7/8	2-19/64	53226	58092
10,5 mm	0.4134		89,0	43,0	31,0	63029	69039
10,7 mm	0.4213		95,0	47,0	33,0	63030	69040
27/64	0.4219	10.72	4-1/2	2-7/8	2-19/64	53127	58093
10,8 mm	0.4252		95,0	47,0	33,0	63031	69041
11,0 mm	0.4331		95,0	47,0	33,0	63032	69042
7/16	0.4375	11.11	4-1/2	2-7/8	2-19/64	53128	58094
11,5 mm	0.4528		95,0	47,0	33,0	63033	69043
29/64	0.4531	11.51	4-3/4	3	2-13/32	53129	58095
15/32	0.4688	11.91	4-3/4	3	2-13/32	53130	58096
12,0 mm	0.4724		102,0	51,0	35,0	63034	69044
31/64	0.4844	12.30	4-3/4	3	2-13/32	53131	58097
12,5 mm	0.4921		102,0	51,0	35,0	63035	69045
1/2	0.5000	12.70	4-3/4	3	2-13/32	53132	58098
12,8 mm	0.5039		102,0	51,0	35,0	63036	69046
13,0 mm	0.5118		102,0	51,0	35,0	63089	69047
33/64	0.5156	13.10	4-3/4	3	2-13/32	53135	58099
13,1 mm	0.5157		102,0	51,0	35,0	63037	69048
13,5 mm	0.5315		107,0	54,0	37,0	63090	69049
14,0 mm	0.5512		107,0	54,0	37,0	63038	69050
9/16	0.5625	14.29	4-3/4	3	2-13/32	53136	58100
14,3 mm	0.5630		111,0	56,0	38,0	63039	69051
14,5 mm	0.5709		111,0	56,0	38,0	63040	69052
15,0 mm	0.5906		111,0	56,0	38,0	63091	69053
5/8	0.6250	15.88	5-3/4	3-1/2	2-51/64	53133	58101
11/16	0.6875	17.46	5-3/4	3-1/2	2-51/64	53137	58102
17,5 mm	0.6890		123,0	62,0	40,0	63041	69054
3/4	0.7500	19.05	5-3/4	4-1/4	3 13/32	53134	58103
19,5 mm	0.7677		131,0	66,0	42,0	63042	69055
20,0 mm	0.7874		131,0	66,0	42,0	63043	69056

3 Flute Drills

Series 103 Fractional	Hardness	Vc (sfm)	DC • in							
			1/8	1/4	3/8	1/2	5/8	3/4		
P CARBON STEELS 1018, 1040, 1080, 1090, 10L50, 1140, 1212, 12L15, 1525, 1536	≤ 175 Bhn or ≤ 7 HRc	295	RPM	9015	4508	3005	2254	1803	1503	
		(236-354)	Fr	0.0026	0.0051	0.0077	0.0102	0.0128	0.0153	
			Feed (ipm)	23.0	23.0	23.0	23.0	23.0	23.0	
	≤ 300 Bhn or ≤ 32 HRc	260	RPM	7946	3973	2649	1986	1589	1324	
		(208-312)	Fr	0.0023	0.0045	0.0068	0.0091	0.0113	0.0136	
			Feed (ipm)	18.0	18.0	18.0	18.0	18.0	18.0	
	≤ 425 Bhn or ≤ 45 HRc	150	RPM	4584	2292	1528	1146	917	764	
		(120-180)	Fr	0.0013	0.0026	0.0039	0.0052	0.0065	0.0079	
			Feed (ipm)	6.0	6.0	6.0	6.0	6.0	6.0	
	K ALLOY STEELS 4140, 4150, 4320, 5120, 5150, 8630, 86L20, 50100	≤ 275 Bhn or ≤ 28 HRc	230	RPM	7029	3514	2343	1757	1406	1171
			(184-276)	Fr	0.0019	0.0038	0.0058	0.0077	0.0096	0.0115
				Feed (ipm)	13.5	13.5	13.5	13.5	13.5	13.5
≤ 375 Bhn or ≤ 40 HRc		145	RPM	4431	2216	1477	1108	886	739	
		(116-174)	Fr	0.0019	0.0038	0.0058	0.0077	0.0096	0.0115	
			Feed (ipm)	8.5	8.5	8.5	8.5	8.5	8.5	
≤ 450 Bhn or ≤ 48 HRc		115	RPM	3514	1757	1171	879	703	586	
		(92-138)	Fr	0.0005	0.0010	0.0015	0.0020	0.0026	0.0031	
			Feed (ipm)	1.8	1.8	1.8	1.8	1.8	1.8	
N CAST IRONS Gray, Malleable, Ductile		≤ 220 Bhn or ≤ 19 HRc	250	RPM	7640	3820	2547	1910	1528	1273
			(200-300)	Fr	0.0026	0.0052	0.0079	0.0105	0.0131	0.0157
				Feed (ipm)	20.0	20.0	20.0	20.0	20.0	20.0
	≤ 330 Bhn or ≤ 36 HRc	195	RPM	5959	2980	1986	1490	1192	993	
		(156-234)	Fr	0.0026	0.0052	0.0078	0.0104	0.0130	0.0156	
			Feed (ipm)	15.5	15.5	15.5	15.5	15.5	15.5	
	H ALUMINUM ALLOYS 2017, 2024, 356, 6061, 7075	≤ 80 Bhn or ≤ 47 HRb	540	RPM	16502	8251	5501	4126	3300	2750
			(432-648)	Fr	0.0032	0.0064	0.0096	0.0128	0.0161	0.0193
				Feed (ipm)	53.0	53.0	53.0	53.0	53.0	53.0
		≤ 150 Bhn or ≤ 7 HRc	455	RPM	13905	6952	4635	3476	2781	2317
			(364-546)	Fr	0.0032	0.0065	0.0097	0.0129	0.0162	0.0194
				Feed (ipm)	45.0	45.0	45.0	45.0	45.0	45.0
H COPPER ALLOYS Alum Bronze, C110, Muntz Brass		≤ 140 Bhn or ≤ 3 HRc	305	RPM	9321	4660	3107	2330	1864	1553
			(244-366)	Fr	0.0019	0.0039	0.0058	0.0077	0.0097	0.0116
				Feed (ipm)	18.0	18.0	18.0	18.0	18.0	18.0
		≤ 200 Bhn or ≤ 23 HRc	160	RPM	4890	2445	1630	1222	978	815
			(128-192)	Fr	0.0016	0.0033	0.0049	0.0065	0.0082	0.0098
				Feed (ipm)	8.0	8.0	8.0	8.0	8.0	8.0
	H TOOL STEELS A2, D2, H13, L2, M2, P20, S7, T15, W2	≤ 250 Bhn or ≤ 24 HRc	85	RPM	2598	1299	866	649	520	433
			(68-102)	Fr	0.0013	0.0026	0.0039	0.0052	0.0065	0.0079
				Feed (ipm)	3.4	3.4	3.4	3.4	3.4	3.4
		≤ 375 Bhn or ≤ 40 HRc	65	RPM	1986	993	662	497	397	331
			(52-78)	Fr	0.0007	0.0013	0.0020	0.0026	0.0033	0.0039
				Feed (ipm)	1.3	1.3	1.3	1.3	1.3	1.3
≤ 475 Bhn or ≤ 50 HRc		50	RPM	1528	764	509	382	306	255	
		(40-60)	Fr	0.0007	0.0013	0.0020	0.0026	0.0033	0.0039	
			Feed (ipm)	1.0	1.0	1.0	1.0	1.0	1.0	

Bhn (Brinell) HRc (Rockwell C) HRb (Rockwell B)
 rpm = Vc x 3.82 / DC
 ipm = Fr x rpm
 reduce speed and feed 30 percent when using uncoated drills
 reduce speed and feed for materials harder than listed
 refer to the SGS Tool Wizard® for complete technical information (www.kyocera-sgstool.com)

3 Flute Drills

Series 103M Metric	Hardness	Vc (m/min)	DC • mm							
			3	6	10	12	16	20		
P CARBON STEELS 1018, 1040, 1080, 1090, 10L50, 1140, 1212, 12L15, 1525, 1536	≤ 175 Bhn or ≤ 7 HRc	90	RPM	9533	4766	2860	2383	1787	1430	
		(72-108)	Fr	0.062	0.124	0.206	0.248	0.330	0.413	
			Feed (mm/min)	590	590	590	590	590	590	
	≤ 300 Bhn or ≤ 32 HRc	79	RPM	8402	4201	2520	2100	1575	1260	
		(63-95)	Fr	0.055	0.110	0.183	0.219	0.292	0.365	
			Feed (mm/min)	460	460	460	460	460	460	
	≤ 425 Bhn or ≤ 45 HRc	46	RPM	4847	2424	1454	1212	909	727	
		(37-55)	Fr	0.032	0.064	0.107	0.128	0.171	0.213	
			Feed (mm/min)	155	155	155	155	155	155	
	K ALLOY STEELS 4140, 4150, 4320, 5120, 5150, 8630, 86L20, 50100	≤ 275 Bhn or ≤ 28 HRc	70	RPM	7432	3716	2230	1858	1394	1115
			(56-84)	Fr	0.046	0.093	0.155	0.186	0.248	0.309
				Feed (mm/min)	345	345	345	345	345	345
≤ 375 Bhn or ≤ 40 HRc		44	RPM	4686	2343	1406	1171	879	703	
		(35-53)	Fr	0.046	0.092	0.153	0.184	0.245	0.306	
			Feed (mm/min)	215	215	215	215	215	215	
≤ 450 Bhn or ≤ 48 HRc		35	RPM	3716	1858	1115	929	697	557	
		(28-42)	Fr	0.012	0.024	0.040	0.048	0.065	0.081	
			Feed (mm/min)	45	45	45	45	45	45	
N CAST IRONS Gray, Malleable, Ductile		≤ 220 Bhn or ≤ 19 HRc	76	RPM	8078	4039	2424	2020	1515	1212
			(61-91)	Fr	0.063	0.126	0.210	0.253	0.337	0.421
				Feed (mm/min)	510	510	510	510	510	510
	≤ 330 Bhn or ≤ 36 HRc	59	RPM	6301	3151	1890	1575	1181	945	
		(48-71)	Fr	0.052	0.105	0.175	0.209	0.279	0.349	
			Feed (mm/min)	330	330	330	330	330	330	
H ALUMINUM ALLOYS 2017, 2024, 356, 6061, 7075	≤ 80 Bhn or ≤ 47 HRb	165	RPM	17449	8725	5235	4362	3272	2617	
		(132-198)	Fr	0.078	0.156	0.260	0.312	0.416	0.520	
			Feed (mm/min)	1360	1360	1360	1360	1360	1360	
	≤ 150 Bhn or ≤ 7 HRc	139	RPM	14703	7351	4411	3676	2757	2205	
		(111-166)	Fr	0.078	0.156	0.261	0.313	0.417	0.521	
			Feed (mm/min)	1150	1150	1150	1150	1150	1150	
	H COPPER ALLOYS Alum Bronze, C110, Muntz Brass	≤ 140 Bhn or ≤ 3 HRc	93	RPM	9856	4928	2957	2464	1848	1478
			(74-112)	Fr	0.047	0.094	0.157	0.189	0.252	0.315
				Feed (mm/min)	465	465	465	465	465	465
		≤ 200 Bhn or ≤ 23 HRc	49	RPM	5170	2585	1551	1293	969	776
			(39-59)	Fr	0.039	0.077	0.129	0.155	0.206	0.258
				Feed (mm/min)	200	200	200	200	200	200
H TOOL STEELS A2, D2, H13, L2, M2, P20, S7, T15, W2	≤ 250 Bhn or ≤ 24 HRc	26	RPM	2747	1373	824	687	515	412	
		(21-31)	Fr	0.031	0.062	0.103	0.124	0.165	0.206	
			Feed (mm/min)	85	85	85	85	85	85	
	≤ 375 Bhn or ≤ 40 HRc	20	RPM	2100	1050	630	525	394	315	
		(16-24)	Fr	0.017	0.033	0.056	0.067	0.089	0.111	
			Feed (mm/min)	35	35	35	35	35	35	
	≤ 475 Bhn or ≤ 50 HRc	15	RPM	1616	808	485	404	303	242	
		(12-18)	Fr	0.015	0.031	0.052	0.062	0.083	0.103	
			Feed (mm/min)	25	25	25	25	25	25	

Bhn (Brinell) HRc (Rockwell C) HRb (Rockwell B)
 rpm = (Vc x 1000) / (DC x 3.14)
 mm/min = Fr x rpm
 reduce speed and feed 30 percent when using uncoated drills
 reduce speed and feed for materials harder than listed
 refer to the SGS Tool Wizard® for complete technical information (www.kyocera-sgstool.com)

Combined Drill & Countersink



Pictured:
Series 301 Set



301 FRACTIONAL SERIES

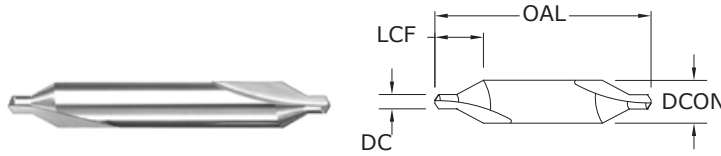

SIZE	inch				EDP NO.	
	DRILL DIAMETER DC	BODY DIAMETER DCON	OVERALL LENGTH OAL	FLUTE LENGTH LCF	UNCOATED	Ti-NAMITE-A (AlTiN)
*00	.025	1/8	1-1/2	.125	57005	57015
*0	1/32	1/8	1-1/2	.130	57006	57016
*1	3/64	1/8	1-1/2	.135	57007	57017
*2	5/64	3/16	1-7/8	.200	57008	57018
*3	7/64	1/4	2	.280	57009	57019
*4	1/8	5/16	2-1/8	.340	57010	57020
*5	3/16	7/16	2-3/4	.475	57011	57021
*6	7/32	1/2	3	.540	57012	57022
*Series 301 Set	—	—	—	—	57075	—

TOLERANCES (inch)

DC = +0.003/-0.000
DCON = -0.0001/-0.0005

- STEELS
- STAINLESS STEELS
- CAST IRON
- HIGH TEMP ALLOYS
- TITANIUM
- HARDENED STEELS
- NON-FERROUS
- PLASTICS/COMPOSITES

For patent information visit
www.ksptpatents.com

Combined Drill & Countersink

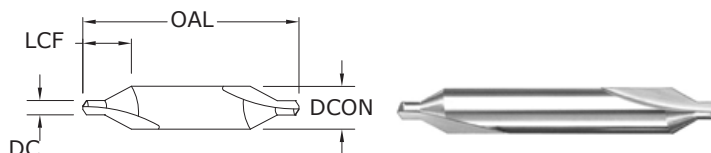
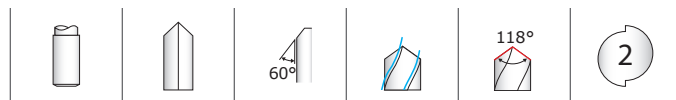

301M
METRIC SERIES

TOLERANCES (mm)

DC = +0,076/-0,000
DCON = -0,0025/-0,0127

- STEELS
- STAINLESS STEELS
- CAST IRON
- HIGH TEMP ALLOYS
- TITANIUM
- HARDENED STEELS
- NON-FERROUS
- PLASTICS/COMPOSITES

For patent information visit www.ksptpatents.com

DRILL DIAMETER DC	BODY DIAMETER DCON	mm		EDP NO.	
		OVERALL LENGTH OAL	FLUTE LENGTH LCF	UNCOATED	Ti-NAMITE-A (AlTiN)
0,5	3,15	20,0	3,0	67005	67035
0,8	3,15	20,0	3,5	67007	67037
1	3,15	31,5	3,5	67009	67039
1,25	3,15	31,5	4,0	67011	67041
1,6	4,0	35,5	5,0	67013	67043
2	5,0	40,0	6,0	67015	67045
2,5	6,3	45,0	7,0	67017	67047
3,15	8,0	50,0	9,0	67019	67049
4	10,0	56,0	11,0	67021	67051
5	12,5	63,0	14,0	67023	67053

Combined Drill & Countersink

Series 301 Fractional	Hardness	Vc (sfm)	DC • in						
			1/32	5/64	1/8	3/16	7/32		
P CARBON STEELS 1018, 1040, 1080, 1090, 10L50, 1140, 1212, 12L15, 1525, 1536	≤ 175 Bhn or ≤ 7 HRc	265	RPM	8098	5399	3239	2314	2025	
		(212-318)	Fr	0.00068	0.0010	0.0017	0.0024	0.0027	
			Feed (ipm)	5.5	5.5	5.5	5.5	5.5	
	≤ 300 Bhn or ≤ 32 HRc	125	RPM	3820	2547	1528	1091	955	
		(100-150)	Fr	0.00065	0.0010	0.0016	0.0023	0.0026	
			Feed (ipm)	2.5	2.5	2.5	2.5	2.5	
	≤ 425 Bhn or ≤ 45 HRc	85	RPM	2598	1732	1039	742	649	
		(68-102)	Fr	0.00038	0.0006	0.0010	0.0013	0.0015	
			Feed (ipm)	1.0	1.0	1.0	1.0	1.0	
	M ALLOY STEELS 4140, 4150, 4320, 5120, 5150, 8630, 86L20, 50100	≤ 275 Bhn or ≤ 28 HRc	230	RPM	7029	4686	2812	2008	1757
			(184-276)	Fr	0.00064	0.0010	0.0016	0.0022	0.0026
				Feed (ipm)	4.5	4.5	4.5	4.5	4.5
≤ 375 Bhn or ≤ 40 HRc		145	RPM	4431	2954	1772	1266	1108	
		(116-174)	Fr	0.00059	0.0009	0.0015	0.0021	0.0023	
			Feed (ipm)	2.6	2.6	2.6	2.6	2.6	
≤ 450 Bhn or ≤ 48 HRc		60	RPM	1834	1222	733	524	458	
		(48-72)	Fr	0.00027	0.0004	0.0007	0.0010	0.0011	
			Feed (ipm)	0.5	0.5	0.5	0.5	0.5	
K STAINLESS STEELS (FREE MACHINING) 303, 416, 420F, 430F 440F		≤ 250 Bhn or ≤ 24 HRc0	210	RPM	6418	4278	2567	1834	1604
			(168-252)	Fr	0.00048	0.0007	0.0012	0.0017	0.0019
				Feed (ipm)	3.1	3.1	3.1	3.1	3.1
	≤ 330 Bhn or ≤ 36 HRc	110	RPM	3362	2241	1345	960	840	
		(88-132)	Fr	0.00028	0.0004	0.0007	0.0010	0.0011	
			Feed (ipm)	0.9	0.9	0.9	0.9	0.9	
K STAINLESS STEELS (DIFFICULT) 304, 316, 321, 13-8 PH, 15-5PH, 17-4 PH, Custom 450	≤ 275 Bhn or ≤ 28 HRc	65	RPM	1986	1324	795	568	497	
		(52-78)	Fr	0.00036	0.0005	0.0009	0.0013	0.0014	
			Feed (ipm)	0.7	0.7	0.7	0.7	0.7	
	≤ 375 Bhn or ≤ 40 HRc	55	RPM	1681	1121	672	480	420	
		(44-66)	Fr	0.00032	0.0005	0.0008	0.0011	0.0013	
			Feed (ipm)	0.5	0.5	0.5	0.5	0.5	
K CAST IRONS Gray, Malleable, Ductile	≤ 220 Bhn or ≤ 19 HRc	280	RPM	8557	5705	3423	2445	2139	
		(224-336)	Fr	0.00084	0.0013	0.0021	0.0029	0.0034	
			Feed (ipm)	7.2	7.2	7.2	7.2	7.2	
	≤ 330 Bhn or ≤ 36 HRc	250	RPM	7640	5093	3056	2183	1910	
		(200-300)	Fr	0.00084	0.0013	0.0021	0.0029	0.0034	
			Feed (ipm)	6.4	6.4	6.4	6.4	6.4	

continued on next page

Combined Drill & Countersink

Series 301 Fractional	Hardness	Vc (sfm)		DC • in					
				1/32	5/64	1/8	3/16	7/32	
N ALUMINUM ALLOYS 2017, 2024, 356, 6061, 7075	≤ 80 Bhn or ≤ 47 HRb	540 (432-648)	RPM	16502	11002	6601	4715	4126	
			Fr	0.00100	0.0015	0.0025	0.0035	0.0040	
			Feed (ipm)	16.5	16.5	16.5	16.5	16.5	
	≤ 150 Bhn or ≤ 7 HRc	455 (364-546)	RPM	13905	9270	5562	3973	3476	
			Fr	0.00100	0.0015	0.0025	0.0035	0.0040	
			Feed (ipm)	13.9	13.9	13.9	13.9	13.9	
	COPPER ALLOYS Alum Bronze, C110, Muntz Brass	≤ 140 Bhn or ≤ 3 HRc	190 (152-228)	RPM	5806	3871	2323	1659	1452
				Fr	0.00048	0.0007	0.0012	0.0017	0.0019
				Feed (ipm)	2.8	2.8	2.8	2.8	2.8
		≤ 200 Bhn or ≤ 23 HRc	175 (140-210)	RPM	5348	3565	2139	1528	1337
				Fr	0.00048	0.0007	0.0012	0.0017	0.0019
				Feed (ipm)	2.6	2.6	2.6	2.6	2.6
PLASTICS Polycarbonate, PVC	500 (400-600)	RPM	15280	10187	6112	4366	3820		
		Fr	0.00100	0.0015	0.0025	0.0035	0.0040		
		Feed (ipm)	15.3	15.3	15.3	15.3	15.3		
S SUPER ALLOYS (NICKEL, COBALT, IRON BASE) Inconel 601, 617, 625, Incoloy 800, Monel 400, Rene, Waspaloy	≤ 220 Bhn or ≤ 19 HRc	40 (32-48)	RPM	1222	815	489	349	306	
			Fr	0.00036	0.0005	0.0009	0.0013	0.0014	
			Feed (ipm)	0.4	0.4	0.4	0.4	0.4	
	≤ 320 Bhn or ≤ 34 HRc	25 (20-30)	RPM	764	509	306	218	191	
			Fr	0.00033	0.0005	0.0008	0.0011	0.0013	
			Feed (ipm)	0.3	0.3	0.3	0.3	0.3	
	≤ 425 Bhn or ≤ 45 HRc	20 (16-24)	RPM	611	407	244	175	153	
			Fr	0.00016	0.0002	0.0004	0.0006	0.0007	
			Feed (ipm)	0.1	0.1	0.1	0.1	0.1	
	TITANIUM ALLOYS Pure Titanium, Ti6Al4V, Ti6Al2Sn4Zr2Mo, Ti4Al4Mo2Sn0.5Si, Ti-6Al4V	≤ 275 Bhn or ≤ 28 HRc	85 (68-102)	RPM	2598	1732	1039	742	649
				Fr	0.00064	0.0010	0.0016	0.0022	0.0026
				Feed (ipm)	1.7	1.7	1.7	1.7	1.7
≤ 350 Bhn or ≤ 38 HRc		65 (52-78)	RPM	1986	1324	795	568	497	
			Fr	0.00036	0.0005	0.0009	0.0013	0.0014	
			Feed (ipm)	0.7	0.7	0.7	0.7	0.7	
≤ 440 Bhn or ≤ 47 HRc	55 (44-66)	RPM	1681	1121	672	480	420		
		Fr	0.00032	0.0005	0.0008	0.0011	0.0013		
		Feed (ipm)	0.5	0.5	0.5	0.5	0.5		
H TOOL STEELS A2, D2, H13, L2, M2, P20, S7, T15, W2	≤ 250 Bhn or ≤ 24 HRc	85 (68-102)	RPM	2598	1732	1039	742	649	
			Fr	0.00035	0.0005	0.0009	0.0012	0.0014	
			Feed (ipm)	0.9	0.9	0.9	0.9	0.9	
	≤ 375 Bhn or ≤ 40 HRc	55 (44-66)	RPM	1681	1121	672	480	420	
			Fr	0.00016	0.0002	0.0004	0.0006	0.0006	
			Feed (ipm)	0.3	0.3	0.3	0.3	0.3	
	≤ 475 Bhn or ≤ 50 HRc	40 (32-48)	RPM	1222	815	489	349	306	
			Fr	0.00016	0.0002	0.0004	0.0006	0.0007	
			Feed (ipm)	0.2	0.2	0.2	0.2	0.2	

Bhn (Brinell) HRc (Rockwell C) HRb (Rockwell B)
 rpm = Vc x 3.82 / DCON
 ipm = Fr x rpm
 reduce speed and feed 30 percent when using uncoated drills
 reduce speed and feed for materials harder than listed
 refer to the SGS Tool Wizard® for complete technical information (www.kyocera-sgtool.com)

Combined Drill & Countersink

Series 301M Metric	Hardness	Vc (m/min)	DC • mm						
			1	1.6	2.5	4	5		
P CARBON STEELS 1018, 1040, 1080, 1090, 10L50, 1140, 1212, 12L15, 1525, 1536	≤ 175 Bhn or ≤ 7 HRc	81	RPM	8155	6422	4078	2569	2055	
		(65-97)	Fr	0.017	0.022	0.034	0.054	0.068	
			Feed (mm/min)	139	139	139	139	139	
	≤ 300 Bhn or ≤ 32 HRc	38	RPM	3847	3029	1923	1212	969	
		(30-46)	Fr	0.016	0.020	0.032	0.051	0.064	
			Feed (mm/min)	62	62	62	62	62	
	≤ 425 Bhn or ≤ 45 HRc	26	RPM	2616	2060	1308	824	659	
		(21-31)	Fr	0.010	0.013	0.020	0.032	0.039	
			Feed (mm/min)	26	26	26	26	26	
	M ALLOY STEELS 4140, 4150, 4320, 5120, 5150, 8630, 86L20, 50100	≤ 275 Bhn or ≤ 28 HRc	70	RPM	7078	5574	3539	2230	1784
			(56-84)	Fr	0.016	0.020	0.032	0.051	0.063
				Feed (mm/min)	113	113	113	113	113
≤ 375 Bhn or ≤ 40 HRc		44	RPM	4462	3514	2231	1406	1125	
		(35-53)	Fr	0.015	0.019	0.030	0.048	0.060	
			Feed (mm/min)	67	67	67	67	67	
≤ 450 Bhn or ≤ 48 HRc		18	RPM	1847	1454	923	582	465	
		(15-22)	Fr	0.007	0.009	0.014	0.022	0.028	
			Feed (mm/min)	13	13	13	13	13	
K STAINLESS STEELS (FREE MACHINING) 303, 416, 420F, 430F 440F		≤ 250 Bhn or ≤ 24 HRc	64	RPM	6463	5089	3231	2036	1629
			(51-77)	Fr	0.012	0.015	0.024	0.038	0.048
				Feed (mm/min)	78	78	78	78	78
	≤ 330 Bhn or ≤ 36 HRc	34	RPM	3385	2666	1693	1066	853	
		(27-40)	Fr	0.007	0.009	0.014	0.023	0.028	
			Feed (mm/min)	24	24	24	24	24	
	K STAINLESS STEELS (DIFFICULT) 304, 316, 321, 13-8 PH, 15-5PH, 17-4 PH, Custom 450	≤ 275 Bhn or ≤ 28 HRc	20	RPM	2000	1575	1000	630	504
			(16-24)	Fr	0.009	0.011	0.018	0.029	0.036
				Feed (mm/min)	18	18	18	18	18
		≤ 375 Bhn or ≤ 40 HRc	17	RPM	1693	1333	846	533	427
			(13-20)	Fr	0.008	0.011	0.017	0.026	0.033
				Feed (mm/min)	14	14	14	14	14
K CAST IRONS Gray, Malleable, Ductile		≤ 220 Bhn or ≤ 19 HRc	85	RPM	8617	6786	4309	2714	2171
			(68-102)	Fr	0.021	0.027	0.042	0.067	0.083
				Feed (mm/min)	181	181	181	181	181
		≤ 330 Bhn or ≤ 36 HRc	76	RPM	7694	6059	3847	2424	1939
			(61-91)	Fr	0.021	0.027	0.042	0.067	0.084
				Feed (mm/min)	162	162	162	162	162

continued on next page

Combined Drill & Countersink

Series 301M Metric	Hardness	Vc (m/min)	DC • mm						
			1	1.6	2.5	4	5		
N ALUMINUM ALLOYS 2017, 2024, 356, 6061, 7075	≤ 80 Bhn or ≤ 47 HRb	165	RPM	16619	13087	8309	5235	4188	
		(132-198)	Fr	0.025	0.032	0.050	0.079	0.099	
			Feed (mm/min)	415	415	415	415	415	
	≤ 150 Bhn or ≤ 7 HRc	139	RPM	14003	11027	7001	4411	3529	
		(111-166)	Fr	0.025	0.032	0.050	0.079	0.099	
			Feed (mm/min)	350	350	350	350	350	
	COPPER ALLOYS Alum Bronze, C110, Muntz Brass	≤ 140 Bhn or ≤ 3 HRc	58	RPM	5847	4605	2924	1842	1474
			(46-69)	Fr	0.012	0.015	0.024	0.038	0.048
				Feed (mm/min)	70	70	70	70	70
		≤ 200 Bhn or ≤ 23 HRc	53	RPM	5386	4241	2693	1696	1357
			(43-64)	Fr	0.012	0.015	0.024	0.038	0.048
				Feed (mm/min)	65	65	65	65	65
PLASTICS Polycarbonate, PVC		152	RPM	15388	12118	7694	4847	3878	
		(122-183)	Fr	0.025	0.032	0.050	0.079	0.099	
			Feed (mm/min)	385	385	385	385	385	
S SUPER ALLOYS (NICKEL, COBALT, IRON BASE) Inconel 601, 617, 625, Incoloy 800, Monel 400, Rene, Waspaloy	≤ 220 Bhn or ≤ 19 HRc	12	RPM	1231	969	616	388	310	
		(10-15)	Fr	0.009	0.011	0.018	0.028	0.035	
			Feed (mm/min)	11	11	11	11	11	
	≤ 320 Bhn or ≤ 34 HRc	8	RPM	769	606	385	242	194	
		(6-9)	Fr	0.008	0.010	0.016	0.025	0.031	
			Feed (mm/min)	6	6	6	6	6	
	≤ 425 Bhn or ≤ 45 HRc	6	RPM	616	485	308	194	155	
		(5-7)	Fr	0.003	0.004	0.006	0.010	0.013	
			Feed (mm/min)	2	2	2	2	2	
	TITANIUM ALLOYS Pure Titanium, Ti6Al4V, Ti6Al2Sn4Zr2Mo, Ti4Al4Mo2Sn0.5Si, Ti-6Al4V	≤ 275 Bhn or ≤ 28 HRc	26	RPM	2616	2060	1308	824	659
			(21-31)	Fr	0.016	0.020	0.032	0.051	0.064
				Feed (mm/min)	42	42	42	42	42
≤ 350 Bhn or ≤ 38 HRc		20	RPM	2000	1575	1000	630	504	
		(16-24)	Fr	0.009	0.011	0.018	0.029	0.036	
			Feed (mm/min)	18	18	18	18	18	
≤ 440 Bhn or ≤ 47 HRc		17	RPM	1693	1333	846	533	427	
		(13-20)	Fr	0.008	0.011	0.017	0.026	0.033	
			Feed (mm/min)	14	14	14	14	14	
H TOOL STEELS A2, D2, H13, L2, M2, P20, S7, T15, W2	≤ 250 Bhn or ≤ 24 HRc	26	RPM	2616	2060	1308	824	659	
		(21-31)	Fr	0.009	0.012	0.018	0.029	0.036	
			Feed (mm/min)	24	24	24	24	24	
	≤ 375 Bhn or ≤ 40 HRc	17	RPM	1693	1333	846	533	427	
		(13-20)	Fr	0.004	0.005	0.008	0.013	0.016	
			Feed (mm/min)	7	7	7	7	7	
	≤ 475 Bhn or ≤ 50 HRc	12	RPM	1231	969	616	388	310	
		(10-15)	Fr	0.004	0.005	0.008	0.013	0.016	
			Feed (mm/min)	5	5	5	5	5	

Bhn (Brinell) HRc (Rockwell C) HRb (Rockwell B)
 rpm = (Vc x 1000) / (DCON x 3.14)
 mm/min = Fr x rpm
 reduce speed and feed 30 percent when using uncoated drills
 reduce speed and feed for materials harder than listed
 refer to the SGS Tool Wizard® for complete technical information (www.kyocera-sgstool.com)

Single Flute Countersink



601 FRACTIONAL SERIES

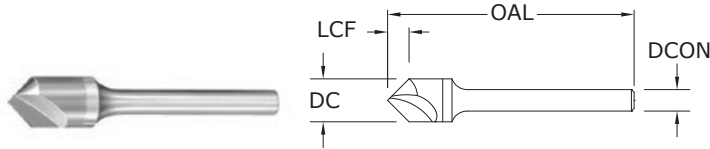

CUTTING DIAMETER DC	SHANK DIAMETER DCON	inch		EDP NO.		
		OVERALL LENGTH OAL	FLUTE LENGTH LCF	UNCOATED 60°	UNCOATED 82°	UNCOATED 90°
1/8	1/8	1-1/2	.062	—	—	74201
1/8	1/8	1-1/2	.072	—	74101	—
1/8	1/8	1-1/2	.108	74001	—	—
3/16	3/16	2	.094	—	—	74204
3/16	3/16	2	.108	—	74104	—
3/16	3/16	2	.163	74004	—	—
1/4	1/4	2	.125	—	—	74207
1/4	1/4	2	.144	—	74107	—
1/4	1/4	2	.217	74007	—	—
*3/8	1/4	2-13/16	.188	—	—	74210
*3/8	1/4	2-13/16	.216	—	74110	—
*3/8	1/4	2-13/16	.325	74010	—	—
*1/2	1/4	2-7/8	.250	—	—	74213
*1/2	1/4	2-7/8	.288	—	74113	—
*1/2	1/4	2-7/8	.433	74013	—	—
*5/8	3/8	3	.313	—	—	74216
*5/8	3/8	3	.360	—	74116	—
*5/8	3/8	3	.541	74016	—	—
*3/4	1/2	3	.375	—	—	74219
*3/4	1/2	3	.431	—	74119	—
*3/4	1/2	3	.650	74019	—	—
*1	1/2	3-1/4	.500	—	—	74222
*1	1/2	3-1/4	.575	—	74122	—
*1	1/2	3-1/4	.866	74022	—	—

*Steel Shank / Con mango de acero / Avec queue en acier / Mit Stahlschaft

TOLERANCES (inch)

1/8–1/4 DIAMETER
DC = +0.0000/–0.0005

3/8–1 DIAMETER
DC = +0.003/–0.000

Included Angle +1°/–1°

- STEELS
- STAINLESS STEELS
- CAST IRON
- HIGH TEMP ALLOYS
- TITANIUM
- HARDENED STEELS
- NON-FERROUS

For patent information visit www.ksptpatents.com

Single Flute Countersink

Series 601 Fractional	Hardness	Vc (sfm)	DC • in								
			1/8	3/16	1/4	3/8	1/2	3/4	1		
P CARBON STEELS 1018, 1040, 1080, 1090, 10L50, 1140, 1212, 12L15, 1525, 1536	≤ 175 Bhn or ≤ 7 HRc	125	RPM	3820	2547	1910	1273	955	637	478	
		(100-150)	Fr	0.0005	0.0008	0.0010	0.0016	0.0021	0.0031	0.0042	
			Feed (ipm)	2.0	2.0	2.0	2.0	2.0	2.0	2.0	
	≤ 300 Bhn or ≤ 32 HRc	60	RPM	1834	1222	917	611	458	306	229	
		(48-72)	Fr	0.0005	0.0007	0.0010	0.0015	0.0020	0.0029	0.0039	
			Feed (ipm)	0.9	0.9	0.9	0.9	0.9	0.9	0.9	
	≤ 425 Bhn or ≤ 45 HRc	45	RPM	1375	917	688	458	344	229	172	
		(36-54)	Fr	0.0003	0.0004	0.0006	0.0009	0.0012	0.0017	0.0023	
			Feed (ipm)	0.4	0.4	0.4	0.4	0.4	0.4	0.4	
	M ALLOY STEELS 4140, 4150, 4320, 5120, 5150, 8630, 86L20, 50100	≤ 275 Bhn or ≤ 28 HRc	95	RPM	2903	1935	1452	968	726	484	363
			(76-114)	Fr	0.0004	0.0007	0.0009	0.0013	0.0018	0.0027	0.0036
				Feed (ipm)	1.3	1.3	1.3	1.3	1.3	1.3	1.3
≤ 375 Bhn or ≤ 40 HRc		60	RPM	1834	1222	917	611	458	306	229	
		(48-72)	Fr	0.0004	0.0007	0.0009	0.0013	0.0017	0.0026	0.0035	
			Feed (ipm)	0.8	0.8	0.8	0.8	0.8	0.8	0.8	
≤ 450 Bhn or ≤ 48 HRc		35	RPM	1070	713	535	357	267	178	134	
		(28-42)	Fr	0.0003	0.0004	0.0006	0.0008	0.0011	0.0017	0.0022	
			Feed (ipm)	0.3	0.3	0.3	0.3	0.3	0.3	0.3	
K STAINLESS STEELS (FREE MACHINING) 303, 416, 420F, 430F 440F		≤ 250 Bhn or ≤ 24 HRc	53	RPM	1620	1080	810	540	405	270	202
			(42-64)	Fr	0.0003	0.0005	0.0006	0.0009	0.0012	0.0019	0.0025
				Feed (ipm)	0.5	0.5	0.5	0.5	0.5	0.5	0.5
	≤ 330 Bhn or ≤ 36 HRc	46	RPM	1406	937	703	469	351	234	176	
		(37-55)	Fr	0.0002	0.0003	0.0004	0.0006	0.0009	0.0013	0.0017	
			Feed (ipm)	0.3	0.3	0.3	0.3	0.3	0.3	0.3	
M STAINLESS STEELS (DIFFICULT) 304, 316, 321, 13-8 PH, 15-5PH, 17-4 PH, Custom 450	≤ 275 Bhn or ≤ 28 HRc	28	RPM	856	570	428	285	214	143	107	
		(22-34)	Fr	0.0004	0.0005	0.0007	0.0011	0.0014	0.0021	0.0028	
			Feed (ipm)	0.3	0.3	0.3	0.3	0.3	0.3	0.3	
	≤ 375 Bhn or ≤ 40 HRc	21	RPM	642	428	321	214	160	107	80	
		(17-25)	Fr	0.0002	0.0002	0.0003	0.0005	0.0006	0.0009	0.0012	
			Feed (ipm)	0.1	0.1	0.1	0.1	0.1	0.1	0.1	
K CAST IRONS Gray, Malleable, Ductile	≤ 220 Bhn or ≤ 19 HRc	105	RPM	3209	2139	1604	1070	802	535	401	
		(84-126)	Fr	0.0006	0.0009	0.0012	0.0018	0.0024	0.0036	0.0047	
			Feed (ipm)	1.9	1.9	1.9	1.9	1.9	1.9	1.9	
	≤ 330 Bhn or ≤ 36 HRc	75	RPM	2292	1528	1146	764	573	382	287	
		(60-90)	Fr	0.0006	0.0009	0.0012	0.0018	0.0024	0.0037	0.0049	
			Feed (ipm)	1.4	1.4	1.4	1.4	1.4	1.4	1.4	

continued on next page

Single Flute Countersink

Series 601 Fractional	Hardness	Vc (sfm)		DC • in							
				1/8	3/16	1/4	3/8	1/2	3/4	1	
N ALUMINUM ALLOYS 2017, 2024, 356, 6061, 7075	≤ 80 Bhn or ≤ 47 HRc	225 (180-270)	RPM	6876	4584	3438	2292	1719	1146	860	
			Fr	0.0008	0.0011	0.0015	0.0023	0.0030	0.0045	0.0061	
			Feed (ipm)	5.2	5.2	5.2	5.2	5.2	5.2	5.2	
	≤ 150 Bhn or ≤ 7 HRc	190 (152-228)	RPM	5806	3871	2903	1935	1452	968	726	
			Fr	0.0008	0.0011	0.0015	0.0023	0.0030	0.0045	0.0061	
			Feed (ipm)	4.4	4.4	4.4	4.4	4.4	4.4	4.4	
	COPPER ALLOYS Alum Bronze, C110, Muntz Brass	≤ 140 Bhn or ≤ 3 HRc	95 (76-114)	RPM	2903	1935	1452	968	726	484	363
				Fr	0.0004	0.0006	0.0008	0.0011	0.0015	0.0023	0.0030
				Feed (ipm)	1.1	1.1	1.1	1.1	1.1	1.1	1.1
		≤ 200 Bhn or ≤ 23 HRc	80 (64-96)	RPM	2445	1630	1222	815	611	407	306
				Fr	0.0004	0.0006	0.0008	0.0012	0.0016	0.0025	0.0033
				Feed (ipm)	1.0	1.0	1.0	1.0	1.0	1.0	1.0
S SUPER ALLOYS (NICKEL, COBALT, IRON BASE) Inconel 601, 617, 625, Incoloy 800, Monel 400, Rene, Waspaloy	≤ 220 Bhn or ≤ 19 HRc	18 (14-22)	RPM	550	367	275	183	138	92	69	
			Fr	0.0002	0.0003	0.0004	0.0005	0.0007	0.0011	0.0015	
			Feed (ipm)	0.1	0.1	0.1	0.1	0.1	0.1	0.1	
	≤ 320 Bhn or ≤ 34 HRc	14 (11-17)	RPM	428	285	214	143	107	71	53	
			Fr	0.0002	0.0004	0.0005	0.0007	0.0009	0.0014	0.0019	
			Feed (ipm)	0.1	0.1	0.1	0.1	0.1	0.1	0.1	
	≤ 425 Bhn or ≤ 45 HRc	12 (10-14)	RPM	367	244	183	122	92	61	46	
			Fr	0.0003	0.0004	0.0005	0.0008	0.0011	0.0016	0.0022	
			Feed (ipm)	0.1	0.1	0.1	0.1	0.1	0.1	0.1	
	TITANIUM ALLOYS Pure Titanium, Ti6Al4V, Ti6Al2Sn4Zr2Mo, Ti4Al4Mo2Sn0.5Si, Ti-6Al4V	≤ 275 Bhn or ≤ 28 HRc	36 (29-43)	RPM	1100	733	550	367	275	183	138
				Fr	0.0005	0.0007	0.0009	0.0014	0.0018	0.0027	0.0036
				Feed (ipm)	0.5	0.5	0.5	0.5	0.5	0.5	0.5
≤ 350 Bhn or ≤ 38 HRc		28 (22-34)	RPM	856	570	428	285	214	143	107	
			Fr	0.0004	0.0005	0.0007	0.0011	0.0014	0.0021	0.0028	
			Feed (ipm)	0.3	0.3	0.3	0.3	0.3	0.3	0.3	
≤ 440 Bhn or ≤ 47 HRc	21 (17-25)	RPM	642	428	321	214	160	107	80		
		Fr	0.0002	0.0002	0.0003	0.0005	0.0006	0.0009	0.0012		
		Feed (ipm)	0.1	0.1	0.1	0.1	0.1	0.1	0.1		
H TOOL STEELS A2, D2, H13, L2, M2, P20, S7, T15, W2	≤ 250 Bhn or ≤ 24 HRc	35 (28-42)	RPM	1070	713	535	357	267	178	134	
			Fr	0.0003	0.0004	0.0006	0.0008	0.0011	0.0017	0.0022	
			Feed (ipm)	0.3	0.3	0.3	0.3	0.3	0.3	0.3	
	≤ 375 Bhn or ≤ 40 HRc	25 (20-30)	RPM	764	509	382	255	191	127	96	
			Fr	0.0001	0.0002	0.0003	0.0004	0.0005	0.0008	0.0010	
			Feed (ipm)	0.1	0.1	0.1	0.1	0.1	0.1	0.1	
	≤ 475 Bhn or ≤ 50 HRc	20 (16-24)	RPM	611	407	306	204	153	102	76	
			Fr	0.0002	0.0002	0.0003	0.0005	0.0007	0.0010	0.0013	
			Feed (ipm)	0.1	0.1	0.1	0.1	0.1	0.1	0.1	

Bhn (Brinell) HRc (Rockwell C) HRb (Rockwell B)
 rpm = Vc x 3.82 / DC
 ipm = Fr x rpm
 reduce speed and feed for materials harder than listed
 refer to the SGS Tool Wizard® for complete technical information (www.kyocera-sgstool.com)

3 Flute Countersink

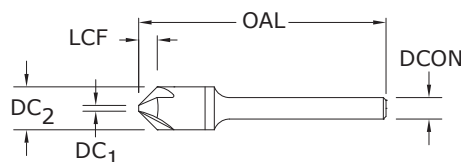
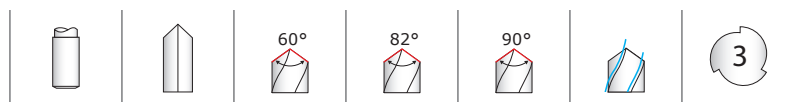

603
FRACTIONAL SERIES

TOLERANCES (inch)

1/8–1/4 DIAMETER

DC = +0.0000/-0.0005

3/8–1 DIAMETER

DC = +0.003/-0.000

Included Angle +1°/-1°

STEELS

STAINLESS STEELS

CAST IRON

HIGH TEMP ALLOYS

TITANIUM

HARDENED STEELS

NON-FERROUS

For patent information visit www.ksptpatents.com

CUTTING DIAMETER DC ₂	SHANK DIAMETER DCON	inch			EDP NO.		
		OVERALL LENGTH OAL	FLUTE LENGTH LCF	TIP DIAMETER DC ₁	UNCOATED 60°	UNCOATED 82°	UNCOATED 90°
1/8	1/8	1-1/2	.045	.040	—	—	74225
1/8	1/8	1-1/2	.049	.040	—	74125	—
1/8	1/8	1-1/2	.078	.035	74025	—	—
3/16	3/16	2	.071	.060	—	—	74228
3/16	3/16	2	.073	.060	—	74128	—
3/16	3/16	2	.123	.045	74028	—	—
1/4	1/4	2	.090	.100	—	—	74231
1/4	1/4	2	.086	.100	—	74131	—
1/4	1/4	2	.156	.070	74031	—	—
*3/8	1/4	2-13/16	.138	.108	—	—	74234
*3/8	1/4	2-13/16	.154	.108	—	74134	—
*3/8	1/4	2-13/16	.238	.100	74034	—	—
*1/2	1/4	2-7/8	.194	.122	—	—	74237
*1/2	1/4	2-7/8	.217	.122	—	74137	—
*1/2	1/4	2-7/8	.335	.113	74037	—	—
*5/8	3/8	3	.249	.138	—	—	74240
*5/8	3/8	3	.280	.138	—	74140	—
*5/8	3/8	3	.430	.128	74040	—	—
*3/4	1/2	3	.304	.153	—	—	74243
*3/4	1/2	3	.343	.153	—	74143	—
*3/4	1/2	3	.526	.143	74043	—	—
*1	1/2	3-1/4	.421	.168	—	—	74246
*1	1/2	3-1/4	.479	.168	—	74146	—
*1	1/2	3-1/4	.729	.158	74046	—	—

*Steel Shank / Con mango de acero / Avec queue en acier / Mit Stahlschaft
NOTE: DC₁ dimension varies based on angle. Contact your KSPT representative or consult SGS Tool Wizard® for dimension information.

3 Flute Countersink

Series 603 Fractional	Hardness	Vc (sfm)	DC • in								
			1/8	3/16	1/4	3/8	1/2	3/4	1		
P CARBON STEELS 1018, 1040, 1080, 1090, 10L50, 1140, 1212, 12L15, 1525, 1536	≤ 175 Bhn or ≤ 7 HRc	125	RPM	3820	2547	1910	1273	955	637	478	
		(100-150)	Fr	0.0008	0.0012	0.0016	0.0024	0.0031	0.0047	0.0063	
			Feed (ipm)	3.0	3.0	3.0	3.0	3.0	3.0	3.0	
	≤ 300 Bhn or ≤ 32 HRc	60	RPM	1834	1222	917	611	458	306	229	
		(48-72)	Fr	0.0007	0.0011	0.0014	0.0021	0.0028	0.0043	0.0057	
			Feed (ipm)	1.3	1.3	1.3	1.3	1.3	1.3	1.3	
	≤ 425 Bhn or ≤ 45 HRc	45	RPM	1375	917	688	458	344	229	172	
		(36-54)	Fr	0.0004	0.0007	0.0009	0.0013	0.0017	0.0026	0.0035	
			Feed (ipm)	0.6	0.6	0.6	0.6	0.6	0.6	0.6	
	M ALLOY STEELS 4140, 4150, 4320, 5120, 5150, 8630, 86L20, 50100	≤ 275 Bhn or ≤ 28 HRc	95	RPM	2903	1935	1452	968	726	484	363
			(76-114)	Fr	0.0007	0.0010	0.0014	0.0021	0.0028	0.0041	0.0055
				Feed (ipm)	2.0	2.0	2.0	2.0	2.0	2.0	2.0
≤ 375 Bhn or ≤ 40 HRc		60	RPM	1834	1222	917	611	458	306	229	
		(48-72)	Fr	0.0007	0.0010	0.0013	0.0020	0.0026	0.0039	0.0052	
			Feed (ipm)	1.2	1.2	1.2	1.2	1.2	1.2	1.2	
≤ 450 Bhn or ≤ 48 HRc		35	RPM	1070	713	535	357	267	178	134	
		(28-42)	Fr	0.0004	0.0006	0.0007	0.0011	0.0015	0.0022	0.0030	
			Feed (ipm)	0.4	0.4	0.4	0.4	0.4	0.4	0.4	
K STAINLESS STEELS (FREE MACHINING) 303, 416, 420F, 430F 440F		≤ 250 Bhn or ≤ 24 HRc	53	RPM	1620	1080	810	540	405	270	202
			(42-64)	Fr	0.0004	0.0006	0.0009	0.0013	0.0017	0.0026	0.0035
				Feed (ipm)	0.7	0.7	0.7	0.7	0.7	0.7	0.7
	≤ 330 Bhn or ≤ 36 HRc	46	RPM	1406	937	703	469	351	234	176	
		(37-55)	Fr	0.0004	0.0005	0.0007	0.0011	0.0014	0.0021	0.0028	
			Feed (ipm)	0.5	0.5	0.5	0.5	0.5	0.5	0.5	
	K STAINLESS STEELS (DIFFICULT) 304, 316, 321, 13-8 PH, 15-5PH, 17-4 PH, Custom 450	≤ 275 Bhn or ≤ 28 HRc	28	RPM	856	570	428	285	214	143	107
			(22-34)	Fr	0.0005	0.0007	0.0009	0.0014	0.0019	0.0028	0.0037
				Feed (ipm)	0.4	0.4	0.4	0.4	0.4	0.4	0.4
		≤ 375 Bhn or ≤ 40 HRc	21	RPM	642	428	321	214	160	107	80
			(17-25)	Fr	0.0002	0.0002	0.0003	0.0005	0.0006	0.0009	0.0012
				Feed (ipm)	0.1	0.1	0.1	0.1	0.1	0.1	0.1
K CAST IRONS Gray, Malleable, Ductile		≤ 220 Bhn or ≤ 19 HRc	105	RPM	3209	2139	1604	1070	802	535	401
			(84-126)	Fr	0.0009	0.0014	0.0018	0.0027	0.0036	0.0054	0.0072
				Feed (ipm)	2.9	2.9	2.9	2.9	2.9	2.9	2.9
		≤ 330 Bhn or ≤ 36 HRc	75	RPM	2292	1528	1146	764	573	382	287
			(60-90)	Fr	0.0009	0.0014	0.0018	0.0027	0.0037	0.0055	0.0073
				Feed (ipm)	2.1	2.1	2.1	2.1	2.1	2.1	2.1

continued on next page

3 Flute Countersink

Series 603 Fractional	Hardness	Vc (sfm)		DC • in							
				1/8	3/16	1/4	3/8	1/2	3/4	1	
N ALUMINUM ALLOYS 2017, 2024, 356, 6061, 7075	≤ 80 Bhn or ≤ 47 HRb	225 (180-270)	RPM	6876	4584	3438	2292	1719	1146	860	
			Fr	0.0011	0.0017	0.0023	0.0034	0.0045	0.0068	0.0091	
			Feed (ipm)	7.8	7.8	7.8	7.8	7.8	7.8	7.8	
	≤ 150 Bhn or ≤ 7 HRc	190 (152-228)	RPM	5806	3871	2903	1935	1452	968	726	
			Fr	0.0011	0.0017	0.0022	0.0034	0.0045	0.0067	0.0090	
			Feed (ipm)	6.5	6.5	6.5	6.5	6.5	6.5	6.5	
	COPPER ALLOYS Alum Bronze, C110, Muntz Brass	≤ 140 Bhn or ≤ 3 HRc	95 (76-114)	RPM	2903	1935	1452	968	726	484	363
				Fr	0.0006	0.0009	0.0012	0.0018	0.0023	0.0035	0.0047
				Feed (ipm)	1.7	1.7	1.7	1.7	1.7	1.7	1.7
		≤ 200 Bhn or ≤ 23 HRc	80 (64-96)	RPM	2445	1630	1222	815	611	407	306
				Fr	0.0006	0.0009	0.0011	0.0017	0.0023	0.0034	0.0046
				Feed (ipm)	1.4	1.4	1.4	1.4	1.4	1.4	1.4
S SUPER ALLOYS (NICKEL, COBALT, IRON BASE) Inconel 601, 617, 625, Incoloy 800, Monel 400, Rene, Waspaloy	≤ 220 Bhn or ≤ 19 HRc	18 (14-22)	RPM	550	367	275	183	138	92	69	
			Fr	0.0004	0.0005	0.0007	0.0011	0.0015	0.0022	0.0029	
			Feed (ipm)	0.2	0.2	0.2	0.2	0.2	0.2	0.2	
	≤ 320 Bhn or ≤ 34 HRc	14 (11-17)	RPM	428	285	214	143	107	71	53	
			Fr	0.0002	0.0004	0.0005	0.0007	0.0009	0.0014	0.0019	
			Feed (ipm)	0.1	0.1	0.1	0.1	0.1	0.1	0.1	
	≤ 425 Bhn or ≤ 45 HRc	12 (10-14)	RPM	367	244	183	122	92	61	46	
			Fr	0.0003	0.0004	0.0005	0.0008	0.0011	0.0016	0.0022	
			Feed (ipm)	0.1	0.1	0.1	0.1	0.1	0.1	0.1	
	TITANIUM ALLOYS Pure Titanium, Ti6Al4V, Ti6Al2Sn4Zr2Mo, Ti4Al4Mo2Sn0.5Si, Ti-6Al4V	≤ 275 Bhn or ≤ 28 HRc	36 (29-43)	RPM	1100	733	550	367	275	183	138
				Fr	0.0007	0.0011	0.0015	0.0022	0.0029	0.0044	0.0058
				Feed (ipm)	0.8	0.8	0.8	0.8	0.8	0.8	0.8
≤ 350 Bhn or ≤ 38 HRc		28 (22-34)	RPM	856	570	428	285	214	143	107	
			Fr	0.0006	0.0009	0.0012	0.0018	0.0023	0.0035	0.0047	
			Feed (ipm)	0.5	0.5	0.5	0.5	0.5	0.5	0.5	
≤ 440 Bhn or ≤ 47 HRc	21 (17-25)	RPM	642	428	321	214	160	107	80		
		Fr	0.0002	0.0002	0.0003	0.0005	0.0006	0.0009	0.0012		
		Feed (ipm)	0.1	0.1	0.1	0.1	0.1	0.1	0.1		
H TOOL STEELS A2, D2, H13, L2, M2, P20, S7, T15, W2	≤ 250 Bhn or ≤ 24 HRc	35 (28-42)	RPM	1070	713	535	357	267	178	134	
			Fr	0.0004	0.0006	0.0007	0.0011	0.0015	0.0022	0.0030	
			Feed (ipm)	0.4	0.4	0.4	0.4	0.4	0.4	0.4	
	≤ 375 Bhn or ≤ 40 HRc	25 (20-30)	RPM	764	509	382	255	191	127	96	
			Fr	0.0003	0.0004	0.0005	0.0008	0.0010	0.0016	0.0021	
			Feed (ipm)	0.2	0.2	0.2	0.2	0.2	0.2	0.2	
	≤ 475 Bhn or ≤ 50 HRc	20 (16-24)	RPM	611	407	306	204	153	102	76	
			Fr	0.0002	0.0002	0.0003	0.0005	0.0007	0.0010	0.0013	
			Feed (ipm)	0.1	0.1	0.1	0.1	0.1	0.1	0.1	

Bhn (Brinell) HRc (Rockwell C) HRb (Rockwell B)
 rpm = Vc x 3.82 / DC
 ipm = Fr x rpm
 reduce speed and feed for materials harder than listed
 refer to the SGS Tool Wizard® for complete technical information (www.kyocera-sgstool.com)

6 Flute Countersink

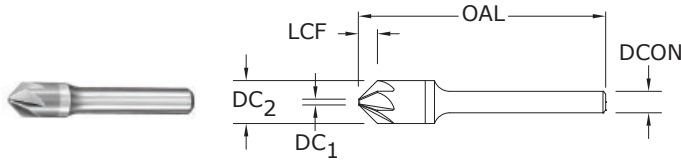

606

FRACTIONAL SERIES

CUTTING DIAMETER DC ₂	SHANK DIAMETER DCON	inch			EDP NO.		
		OVERALL LENGTH OAL	FLUTE LENGTH LCF	TIP DIAMETER DC ₁	UNCOATED 60°	UNCOATED 82°	UNCOATED 90°
1/8	1/8	1-1/2	.045	.035	—	—	74249
1/8	1/8	1-1/2	.052	.035	—	74149	—
1/8	1/8	1-1/2	.078	.035	74049	—	—
3/16	3/16	2	.071	.045	—	—	74252
3/16	3/16	2	.082	.045	—	74152	—
3/16	3/16	2	.123	.045	74052	—	—
1/4	1/4	2	.090	.070	—	—	74255
1/4	1/4	2	.104	.070	—	74155	—
1/4	1/4	2	.156	.070	74055	—	—
*3/8	1/4	2-13/16	.138	.100	—	—	74258
*3/8	1/4	2-13/16	.158	.100	—	74158	—
*3/8	1/4	2-13/16	.238	.100	74058	—	—
*1/2	1/4	2-7/8	.170	.160	—	—	74261
*1/2	1/4	2-7/8	.196	.160	—	74161	—
*1/2	1/4	2-7/8	.294	.160	74061	—	—
*5/8	3/8	3	.218	.190	—	—	74264
*5/8	3/8	3	.250	.190	—	74164	—
*5/8	3/8	3	.377	.190	74064	—	—
*3/4	1/2	3	.265	.220	—	—	74267
*3/4	1/2	3	.305	.220	—	74167	—
*3/4	1/2	3	.459	.220	74067	—	—
*1	1/2	3-1/4	.370	.260	—	—	74270
*1	1/2	3-1/4	.426	.260	—	74170	—
*1	1/2	3-1/4	.641	.260	74070	—	—

*Steel Shank / Con mango de acero / Avec queue en acier / Mit Stahlschaft
 NOTE: DC₁ dimension varies based on angle. Contact your KSPT representative or consult SGS Tool Wizard® for dimension information.

TOLERANCES (inch)

1/8–1/4 DIAMETER
 DC = +0.0000/–0.0005

3/8–1 DIAMETER
 DC = +0.003/–0.000

Included Angle +1°/–1°

- STEELS
- STAINLESS STEELS
- CAST IRON
- HIGH TEMP ALLOYS
- TITANIUM
- NON-FERROUS
- HARDENED STEELS

For patent information visit www.ksptpatents.com

6 Flute Countersink

Series 606 Fractional	Hardness	Vc (sfm)	DC • in								
			1/8	3/16	1/4	3/8	1/2	3/4	1		
P CARBON STEELS 1018, 1040, 1080, 1090, 10L50, 1140, 1212, 12L15, 1525, 1536	≤ 175 Bhn or ≤ 7 HRc	125	RPM	3820	2547	1910	1273	955	637	478	
		(100-150)	Fr	0.0010	0.0016	0.0021	0.0031	0.0042	0.0063	0.0084	
			Feed (ipm)	4.0	4.0	4.0	4.0	4.0	4.0	4.0	
	≤ 300 Bhn or ≤ 32 HRc	60	RPM	1834	1222	917	611	458	306	229	
		(48-72)	Fr	0.0010	0.0015	0.0020	0.0029	0.0039	0.0059	0.0079	
			Feed (ipm)	1.8	1.8	1.8	1.8	1.8	1.8	1.8	
	≤ 425 Bhn or ≤ 45 HRc	45	RPM	1375	917	688	458	344	229	172	
		(36-54)	Fr	0.0006	0.0009	0.0012	0.0017	0.0023	0.0035	0.0047	
			Feed (ipm)	0.8	0.8	0.8	0.8	0.8	0.8	0.8	
	M ALLOY STEELS 4140, 4150, 4320, 5120, 5150, 8630, 86L20, 50100	≤ 275 Bhn or ≤ 28 HRc	95	RPM	2903	1935	1452	968	726	484	363
			(76-114)	Fr	0.0009	0.0013	0.0018	0.0027	0.0036	0.0054	0.0072
				Feed (ipm)	2.6	2.6	2.6	2.6	2.6	2.6	2.6
≤ 375 Bhn or ≤ 40 HRc		60	RPM	1834	1222	917	611	458	306	229	
		(48-72)	Fr	0.0009	0.0014	0.0019	0.0028	0.0037	0.0056	0.0074	
			Feed (ipm)	1.7	1.7	1.7	1.7	1.7	1.7	1.7	
≤ 450 Bhn or ≤ 48 HRc		35	RPM	1070	713	535	357	267	178	134	
		(28-42)	Fr	0.0006	0.0008	0.0011	0.0017	0.0022	0.0034	0.0045	
			Feed (ipm)	0.6	0.6	0.6	0.6	0.6	0.6	0.6	
K STAINLESS STEELS (DIFFICULT) 304, 316, 321, 13-8 PH, 15-5PH, 17-4 PH, Custom 450		≤ 330 Bhn or ≤ 36 HRc	(42-64)	Fr	0.0006	0.0009	0.0012	0.0019	0.0025	0.0037	0.0049
				Feed (ipm)	1.0	1.0	1.0	1.0	1.0	1.0	1.0
				46	RPM	1406	937	703	469	351	234
	≤ 275 Bhn or ≤ 28 HRc	(22-34)	Fr	0.0005	0.0007	0.0010	0.0015	0.0020	0.0030	0.0040	
			Feed (ipm)	0.7	0.7	0.7	0.7	0.7	0.7	0.7	
			28	RPM	856	570	428	285	214	143	107
≤ 375 Bhn or ≤ 40 HRc	(17-25)	Fr	0.0007	0.0011	0.0014	0.0021	0.0028	0.0042	0.0056		
		Feed (IPM)	0.6	0.6	0.6	0.6	0.6	0.6	0.6		
		21	RPM	642	428	321	214	160	107	80	
≤ 220 Bhn or ≤ 19 HRc	(84-126)	Fr	0.0003	0.0005	0.0006	0.0009	0.0012	0.0019	0.0025		
		Feed (IPM)	0.2	0.2	0.2	0.2	0.2	0.2	0.2		
		105	RPM	3209	2139	1604	1070	802	535	401	
K CAST IRONS Gray, Malleable, Ductile	≤ 330 Bhn or ≤ 36 HRc	(60-90)	Fr	0.0012	0.0018	0.0024	0.0036	0.0049	0.0073	0.0097	
			Feed (ipm)	3.9	3.9	3.9	3.9	3.9	3.9	3.9	
			75	RPM	2292	1528	1146	764	573	382	287
	≤ 330 Bhn or ≤ 36 HRc	(60-90)	Fr	0.0012	0.0018	0.0024	0.0037	0.0049	0.0073	0.0098	
			Feed (ipm)	2.8	2.8	2.8	2.8	2.8	2.8	2.8	
			75	RPM	2292	1528	1146	764	573	382	287

continued on next page

6 Flute Countersink

Series 606 Fractional	Hardness	Vc (sfm)	DC • in								
			1/8	3/16	1/4	3/8	1/2	3/4	1		
ALUMINUM ALLOYS 2017, 2024, 356, 6061, 7075	≤ 80 Bhn or ≤ 47 HRB	225	RPM	6876	4584	3438	2292	1719	1146	860	
		(180-270)	Fr	0.0015	0.0022	0.0030	0.0045	0.0060	0.0090	0.0120	
			Feed (ipm)	10.3	10.3	10.3	10.3	10.3	10.3	10.3	
	≤ 150 Bhn or ≤ 7 HRc	190	RPM	5806	3871	2903	1935	1452	968	726	
		(152-228)	Fr	0.0015	0.0022	0.0030	0.0045	0.0060	0.0090	0.0120	
			Feed (ipm)	8.7	8.7	8.7	8.7	8.7	8.7	8.7	
	COPPER ALLOYS Alum Bronze, C110, Muntz Brass	≤ 140 Bhn or ≤ 3 HRc	95	RPM	2903	1935	1452	968	726	484	363
			(76-114)	Fr	0.0008	0.0011	0.0015	0.0023	0.0030	0.0045	0.0061
				Feed (ipm)	2.2	2.2	2.2	2.2	2.2	2.2	2.2
		≤ 200 Bhn or ≤ 23 HRc	80	RPM	2445	1630	1222	815	611	407	306
			(64-96)	Fr	0.0008	0.0012	0.0016	0.0023	0.0031	0.0047	0.0062
				Feed (ipm)	1.9	1.9	1.9	1.9	1.9	1.9	1.9
SUPER ALLOYS (NICKEL, COBALT, IRON BASE) Inconel 601, 617, 625, Incoloy 800, Monel 400, Rene, Waspaloy		≤ 220 Bhn or ≤ 19 HRc	18	RPM	550	367	275	183	138	92	69
			(14-22)	Fr	0.0005	0.0008	0.0011	0.0016	0.0022	0.0033	0.0044
				Feed (ipm)	0.3	0.3	0.3	0.3	0.3	0.3	0.3
		≤ 320 Bhn or ≤ 34 HRc	14	RPM	428	285	214	143	107	71	53
			(11-17)	Fr	0.0005	0.0007	0.0009	0.0014	0.0019	0.0028	0.0037
				Feed (ipm)	0.2	0.2	0.2	0.2	0.2	0.2	0.2
	≤ 425 Bhn or ≤ 45 HRc	12	RPM	367	244	183	122	92	61	46	
		(10-14)	Fr	0.0003	0.0004	0.0005	0.0008	0.0011	0.0016	0.0022	
			Feed (ipm)	0.1	0.1	0.1	0.1	0.1	0.1	0.1	
	TITANIUM ALLOYS Pure Titanium, Ti6Al4V, Ti6Al2Sn4Zr2Mo, Ti4Al4Mo2Sn0.5Si, Ti-6Al4V	≤ 275 Bhn or ≤ 28 HRc	36	RPM	1100	733	550	367	275	183	138
			(29-43)	Fr	0.0009	0.0014	0.0018	0.0027	0.0036	0.0055	0.0073
				Feed (ipm)	1.0	1.0	1.0	1.0	1.0	1.0	1.0
≤ 350 Bhn or ≤ 38 HRc		28	RPM	856	570	428	285	214	143	107	
		(22-34)	Fr	0.0007	0.0011	0.0014	0.0021	0.0028	0.0042	0.0056	
			Feed (ipm)	0.6	0.6	0.6	0.6	0.6	0.6	0.6	
≤ 440 Bhn or ≤ 47 HRc		21	RPM	642	428	321	214	160	107	80	
		(17-25)	Fr	0.0003	0.0005	0.0006	0.0009	0.0012	0.0019	0.0025	
			Feed (ipm)	0.2	0.2	0.2	0.2	0.2	0.2	0.2	

continued on next page

6 Flute Countersink

Series 606 Fractional	Hardness	Vc (sfm)	DC • in							
			1/8	3/16	1/4	3/8	1/2	3/4	1	
H TOOL STEELS A2, D2, H13, L2, M2, P20, S7, T15, W2	≤ 250 Bhn or ≤ 24 HRc	35	RPM	1070	713	535	357	267	178	134
		(28-42)	Fr	0.0006	0.0008	0.0011	0.0017	0.0022	0.0034	0.0045
			Feed (ipm)	0.6	0.6	0.6	0.6	0.6	0.6	0.6
	≤ 375 Bhn or ≤ 40 HRc	25	RPM	764	509	382	255	191	127	96
		(20-30)	Fr	0.0003	0.0004	0.0005	0.0008	0.0010	0.0016	0.0021
			Feed (ipm)	0.2	0.2	0.2	0.2	0.2	0.2	0.2
	≤ 475 Bhn or ≤ 50 HRc	20	RPM	611	407	306	204	153	102	76
		(16-24)	Fr	0.0003	0.0005	0.0007	0.0010	0.0013	0.0020	0.0026
			Feed (ipm)	0.2	0.2	0.2	0.2	0.2	0.2	0.2

Bhn (Brinell) HRc (Rockwell C) HRb (Rockwell B)

$rpm = Vc \times 3.82 / DC$

$ipm = Fr \times rpm$

reduce speed and feed for materials harder than listed

refer to the SGS Tool Wizard® for complete technical information (www.kyocera-sgstool.com)

Straight Flute Accu-Reamer



5xD



45°



200

FRACTIONAL SERIES

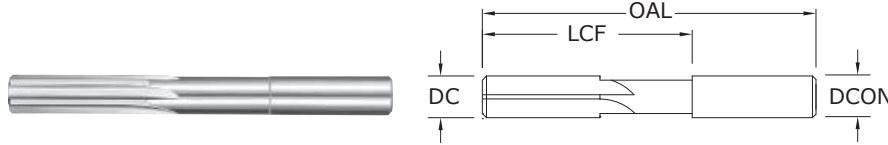

inch					EDP NO.
CUTTING DIAMETER DC	SHANK DIAMETER DCON	MAXIMUM REAM LENGTH LCF	OVERALL LENGTH OAL	NO. OF FLUTES	UNCOATED
3/64	3/64	3/4	1-1/2	4	70003
1/16	1/16	3/4	1-1/2	4	70004
5/64	5/64	1	2	4	70005
3/32	3/32	1-1/4	2-1/4	4	70006
7/64	7/64	1-1/4	2-1/4	4	70007
1/8	1/8	1-1/4	2-1/4	4	70008
9/64	9/64	1-1/2	2-1/2	4	70009
5/32	5/32	1-1/2	2-1/2	4	70010
11/64	11/64	1-3/4	2-3/4	4	70011
3/16	3/16	1-3/4	2-3/4	4	70012
13/64	13/64	2	3	4	70013
7/32	7/32	2	3	4	70014
15/64	15/64	2	3	4	70015
1/4	1/4	2	3	4	70016
17/64	17/64	2-1/4	3-1/4	6	70017
9/32	9/32	2-1/4	3-1/4	6	70018
19/64	19/64	2-1/4	3-1/4	6	70019
5/16	5/16	2-1/4	3-1/4	6	70020
21/64	21/64	2-3/8	3-1/2	6	70021
11/32	11/32	2-3/8	3-1/2	6	70022
23/64	23/64	2-3/8	3-1/2	6	70023
3/8	3/8	2-3/8	3-1/2	6	70024
25/64	25/64	2-7/8	4	6	70025
13/32	13/32	2-7/8	4	6	70026
27/64	27/64	2-7/8	4	6	70027
7/16	7/16	2-7/8	4	6	70028
29/64	29/64	2-7/8	4	6	70029
15/32	15/32	2-7/8	4	6	70030
31/64	31/64	2-7/8	4	6	70031
1/2	1/2	2-7/8	4	6	70032

TOLERANCES (inch)

DC = +0.0002/-0.0000
 DCON = +0.0002/-0.0000

- STEELS
- STAINLESS STEELS
- CAST IRON
- HIGH TEMP ALLOYS
- TITANIUM
- NON-FERROUS
- HARDENED STEELS

For patent information visit www.ksptpatents.com

continued on next page

Straight Flute Accu-Reamer

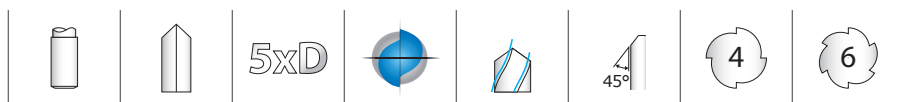

200
FRACTIONAL SERIES

CONTINUED

TOLERANCES (inch)

DC = +0.0002/-0.0000

DCON = +0.0002/-0.0000

CUTTING DIAMETER DC	inch			NO. OF FLUTES
	SHANK DIAMETER DCON	MAXIMUM REAM LENGTH LCF	OVERALL LENGTH OAL	
.0470 – .0625	1/16	3/4	1-1/2	4
.0626 – .0781	5/64	1	2	4
.0782 – .0938	3/32	1-1/4	2-1/4	4
.0939 – .1094	7/64	1-1/4	2-1/4	4
.1095 – .1250	1/8	1-1/4	2-1/4	4
.1251 – .1406	9/64	1-1/2	2-1/2	4
.1407 – .1562	5/32	1-1/2	2-1/2	4
.1563 – .1719	11/64	1-3/4	2-3/4	4
.1720 – .1875	3/16	1-3/4	2-3/4	4
.1876 – .2031	13/64	2	3	4
.2032 – .2188	7/32	2	3	4
.2189 – .2344	15/64	2	3	4
.2345 – .2500	1/4	2	3	4
.2501 – .2656	17/64	2-1/4	3-1/4	6
.2657 – .2812	9/32	2-1/4	3-1/4	6
.2813 – .2969	19/64	2-1/4	3-1/4	6
.2970 – .3125	5/16	2-1/4	3-1/4	6
.3126 – .3281	21/64	2-3/8	3-1/2	6
.3282 – .3438	11/32	2-3/8	3-1/2	6
.3439 – .3594	23/64	2-3/8	3-1/2	6
.3595 – .3750	3/8	2-3/8	3-1/2	6
.3751 – .3906	25/64	2-7/8	4	6
.3907 – .4062	13/32	2-7/8	4	6
.4063 – .4219	27/64	2-7/8	4	6
.4220 – .4375	7/16	2-7/8	4	6
.4376 – .4531	29/64	2-7/8	4	6
.4532 – .4688	15/32	2-7/8	4	6
.4689 – .4844	31/64	2-7/8	4	6
.4845 – .5000	1/2	2-7/8	4	6

SER 200 Fractional reamers can be ordered to specific diameters according to the size range of Cutting Diameter DC. Please order as:

- 200. Then the size of the cut diameter in fractional format.
- i.e. 200.0492
- Description: Series 200 size 0.0492
- For Metric sizes convert to fractional inches (i.e. $\div 25.4$)
- The above sample would be a 1.25mm size ($1.25 \div 25.4 = 0.0492$)

All other dimensions are fractional as per table including the Shank

Straight Flute Accu-Reamer

Series 200 Fractional	Hardness	Vc (sfm)	DC • in								
			1/16	1/8	3/16	1/4	5/16	3/8	1/2		
P CARBON STEELS 1018, 1040, 1080, 1090, 10L50, 1140, 1212, 12L15, 1525, 1536	≤ 175 Bhn or ≤ 7 HRc	150	RPM	9168	4584	3056	2292	1834	1528	1146	
		(120-180)	Fr	0.0018	0.0035	0.0053	0.0071	0.0088	0.0106	0.0141	
			Feed (ipm)	16.5	16.0	16.2	16.3	16.1	16.2	16.2	
	≤ 300 Bhn or ≤ 32 HRc	75	RPM	4584	2292	1528	1146	917	764	573	
		(60-90)	Fr	0.0016	0.0031	0.0047	0.0062	0.0078	0.0093	0.0124	
			Feed (ipm)	7.3	7.1	7.2	7.1	7.2	7.1	7.1	
	≤ 425 Bhn or ≤ 45 HRc	55	RPM	3362	1681	1121	840	672	560	420	
		(44-66)	Fr	0.0009	0.0019	0.0028	0.0037	0.0046	0.0056	0.0074	
			Feed (ipm)	3.0	3.2	3.1	3.1	3.1	3.1	3.1	
	M ALLOY STEELS 4140, 4150, 4320, 5120, 5150, 8630, 86L20, 50100	≤ 275 Bhn or ≤ 28 HRc	115	RPM	7029	3514	2343	1757	1406	1171	879
			(92-138)	Fr	0.0015	0.0030	0.0045	0.0060	0.0075	0.0090	0.0120
				Feed (ipm)	10.5	10.5	10.5	10.5	10.5	10.5	10.5
≤ 375 Bhn or ≤ 40 HRc		70	RPM	4278	2139	1426	1070	856	713	535	
		(56-84)	Fr	0.0015	0.0030	0.0045	0.0060	0.0075	0.0090	0.0120	
			Feed (ipm)	6.4	6.4	6.4	6.4	6.4	6.4	6.4	
≤ 450 Bhn or ≤ 48 HRc		45	RPM	2750	1375	917	688	550	458	344	
		(36-54)	Fr	0.0009	0.0019	0.0028	0.0037	0.0046	0.0056	0.0074	
			Feed (ipm)	2.5	2.6	2.6	2.5	2.5	2.6	2.5	
K STAINLESS STEELS (FREE MACHINING) 303, 416, 420F, 430F 440F		≤ 250 Bhn or ≤ 24 HRc	75	RPM	4584	2292	1528	1146	917	764	573
			(60-90)	Fr	0.0010	0.0020	0.0029	0.0039	0.0049	0.0059	0.0078
				Feed (ipm)	4.6	4.6	4.4	4.5	4.5	4.5	4.5
	≤ 330 Bhn or ≤ 36 HRc	55	RPM	3362	1681	1121	840	672	560	420	
		(44-66)	Fr	0.0008	0.0015	0.0023	0.0030	0.0038	0.0045	0.0060	
			Feed (ipm)	2.7	2.5	2.6	2.5	2.6	2.5	2.5	
N STAINLESS STEELS (DIFFICULT) 304, 316, 321, 13-8 PH, 15-5PH, 17-4 PH, Custom 450	≤ 275 Bhn or ≤ 28 HRc	35	RPM	2139	1070	713	535	428	357	267	
		(28-42)	Fr	0.0010	0.0020	0.0029	0.0039	0.0049	0.0059	0.0078	
			Feed (ipm)	2.1	2.1	2.1	2.1	2.1	2.1	2.1	
	≤ 375 Bhn or ≤ 40 HRc	25	RPM	1528	764	509	382	306	255	191	
		(20-30)	Fr	0.0006	0.0013	0.0019	0.0025	0.0031	0.0038	0.0050	
			Feed (ipm)	0.9	1.0	1.0	1.0	0.9	1.0	1.0	
K CAST IRONS Gray, Malleable, Ductile	≤ 220 Bhn or ≤ 19 HRc	125	RPM	7640	3820	2547	1910	1528	1273	955	
		(100-150)	Fr	0.0020	0.0040	0.0060	0.0081	0.0101	0.0121	0.0161	
			Feed (ipm)	15.3	15.3	15.3	15.5	15.4	15.4	15.4	
	≤ 330 Bhn or ≤ 36 HRc	95	RPM	5806	2903	1935	1452	1161	968	726	
		(76-114)	Fr	0.0020	0.0040	0.0060	0.0081	0.0101	0.0121	0.0161	
			Feed (ipm)	11.6	11.6	11.6	11.8	11.7	11.7	11.7	
N ALUMINUM ALLOYS 2017, 2024, 356, 6061, 7075	≤ 80 Bhn or ≤ 47 HRb	270	RPM	16502	8251	5501	4126	3300	2750	2063	
		(216-324)	Fr	0.0025	0.0050	0.0075	0.0100	0.0125	0.0150	0.0200	
			Feed (ipm)	41.3	41.3	41.3	41.3	41.3	41.3	41.3	
	≤ 150 Bhn or ≤ 7 HRc	230	RPM	14058	7029	4686	3514	2812	2343	1757	
		(184-276)	Fr	0.0025	0.0050	0.0075	0.0100	0.0125	0.0150	0.0200	
			Feed (ipm)	35.1	35.1	35.1	35.1	35.1	35.1	35.1	
N COPPER ALLOYS Alum Bronze, C110, Muntz Brass	≤ 140 Bhn or ≤ 3 HRc	115	RPM	7029	3514	2343	1757	1406	1171	879	
		(92-138)	Fr	0.0013	0.0026	0.0038	0.0051	0.0064	0.0077	0.0102	
			Feed (ipm)	9.1	9.1	8.9	9.0	9.0	9.0	9.0	
	≤ 200 Bhn or ≤ 23 HRc	95	RPM	5806	2903	1935	1452	1161	968	726	
		(76-114)	Fr	0.0013	0.0026	0.0038	0.0051	0.0064	0.0077	0.0102	
			Feed (ipm)	7.5	7.5	7.4	7.4	7.4	7.5	7.4	

continued on next page

Straight Flute Accu-Reamer

Series 200 Fractional	Hardness	Vc (sfm)		DC • in							
				1/16	1/8	3/16	1/4	5/16	3/8	1/2	
S SUPER ALLOYS (NICKEL, COBALT, IRON BASE) Inconel 601, 617, 625, Incoloy 800, Monel 400, Rene, Waspaloy	≤ 220 Bhn or ≤ 19 HRc	20 (16-24)	RPM	1222	611	407	306	244	204	153	
			Fr	0.0008	0.0015	0.0023	0.0030	0.0038	0.0045	0.0060	
			Feed (ipm)	1.0	0.9	0.9	0.9	0.9	0.9	0.9	
	≤ 320 Bhn or ≤ 34 HRc	15 (12-18)	RPM	917	458	306	229	183	153	115	
			Fr	0.0006	0.0013	0.0019	0.0025	0.0031	0.0038	0.0050	
			Feed (ipm)	0.6	0.6	0.6	0.6	0.6	0.6	0.6	
	≤ 425 Bhn or ≤ 45 HRc	10 (8-12)	RPM	611	306	204	153	122	102	76	
			Fr	0.0004	0.0007	0.0011	0.0015	0.0018	0.0022	0.0029	
			Feed (ipm)	0.2	0.2	0.2	0.2	0.2	0.2	0.2	
	H TITANIUM ALLOYS Pure Titanium, Ti6Al4V, Ti6Al2Sn4Zr2Mo, Ti4Al4Mo2Sn0.5Si, Ti-6Al4V	≤ 275 Bhn or ≤ 28 HRc	45 (36-54)	RPM	2750	1375	917	688	550	458	344
				Fr	0.0015	0.0030	0.0045	0.0060	0.0075	0.0090	0.0120
				Feed (ipm)	4.1	4.1	4.1	4.1	4.1	4.1	4.1
≤ 350 Bhn or ≤ 38 HRc		35 (28-42)	RPM	2139	1070	713	535	428	357	267	
			Fr	0.0010	0.0020	0.0029	0.0039	0.0049	0.0059	0.0078	
			Feed (ipm)	2.1	2.1	2.1	2.1	2.1	2.1	2.1	
≤ 440 Bhn or ≤ 47 HRc		25 (20-30)	RPM	1528	764	509	382	306	255	191	
			Fr	0.0006	0.0013	0.0019	0.0025	0.0031	0.0038	0.0050	
			Feed (ipm)	0.9	1.0	1.0	1.0	0.9	1.0	1.0	
H TOOL STEELS A2, D2, H13, L2, M2, P20, S7, T15, W2		≤ 250 Bhn or ≤ 24 HRc	40 (32-48)	RPM	2445	1222	815	611	489	407	306
				Fr	0.0010	0.0020	0.0029	0.0039	0.0049	0.0059	0.0078
				Feed (ipm)	2.4	2.4	2.4	2.4	2.4	2.4	2.4
	≤ 375 Bhn or ≤ 40 HRc	25 (20-30)	RPM	1528	764	509	382	306	255	191	
			Fr	0.0006	0.0013	0.0019	0.0025	0.0031	0.0038	0.0050	
			Feed (ipm)	0.9	1.0	1.0	1.0	0.9	1.0	1.0	
	≤ 475 Bhn or ≤ 50 HRc	20 (16-24)	RPM	1222	611	407	306	244	204	153	
			Fr	0.0004	0.0008	0.0012	0.0016	0.0019	0.0023	0.0031	
			Feed (ipm)	0.5	0.5	0.5	0.5	0.5	0.5	0.5	
	≤ 655 Bhn or ≤ 60 HRc	14 (11-17)	RPM	856	428	285	214	171	143	107	
			Fr	0.0003	0.0007	0.0011	0.0014	0.0018	0.0021	0.0028	
			Feed (ipm)	0.3	0.3	0.3	0.3	0.3	0.3	0.3	

Bhn (Brinell) HRc (Rockwell C) HRb (Rockwell B)
 rpm = Vc x 3.82 / DC
 ipm = Fr x rpm
 increase speed and feed 30 percent when using coated reamers
 reduce speed and feed for materials harder than listed
 refer to the SGS Tool Wizard® for complete technical information (www.kyocera-sgstool.com)

METRIC

Straight Flute Reamer



3-6xD



45°



201M
METRIC SERIES

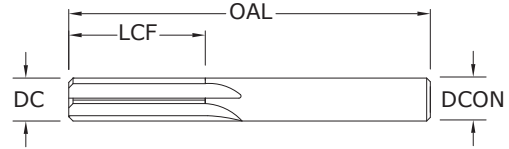

CUTTING DIAMETER DC	SHANK DIAMETER DCON	mm		NO. OF FLUTES	EDP NO.
		MAXIMUM REAM LENGTH LCF	OVERALL LENGTH OAL		UNCOATED
1,0	1,0	6,0	32,0	4	81001
1,5	1,5	9,5	38,0	4	81003
2,0	2,0	12,7	44,0	4	81005
2,5	2,5	12,7	50,0	4	81007
3,0	3,0	16,0	57,0	4	81009
3,5	3,5	19,0	63,0	4	81011
4,0	4,0	19,0	63,0	4	81013
4,5	4,5	22,0	70,0	4	81015
5,0	5,0	25,0	75,0	4	81017
5,5	5,5	25,0	75,0	4	81019
6,0	6,0	25,0	75,0	4	81021
7,0	7,0	28,0	82,0	6	81023
8,0	8,0	28,0	82,0	6	81025
9,0	9,0	31,0	89,0	6	81027
10,0	10,0	31,0	89,0	6	81029

TOLERANCES (mm)

1-6 DIAMETER
DC = +0,008/-0,000

>6-10 DIAMETER
DC = +0,010/-0,000

- STEELS
- STAINLESS STEELS
- CAST IRON
- HIGH TEMP ALLOYS
- TITANIUM
- NON-FERROUS
- HARDENED STEELS

For patent information visit www.ksptpatents.com

Straight Flute Reamer

Series 201M Metric	Hardness	Vc (m/min)	DC • mm									
			1	2	3	4	6	8	10			
P	CARBON STEELS 1018, 1040, 1080, 1090, 10L50, 1140, 1212, 12L15, 1525, 1536	≤ 175 Bhn or ≤ 7 HRc	46	RPM	14541	7271	4847	3635	2424	1818	1454	
			(37-55)	Fr	0.028	0.056	0.085	0.113	0.169	0.226	0.282	
				Feed (mm/min)	410	410	410	410	410	410	410	
		≤ 300 Bhn or ≤ 32 HRc	23	RPM	7271	3635	2424	1818	1212	909	727	
			(18-27)	Fr	0.025	0.050	0.074	0.099	0.149	0.198	0.248	
				Feed (mm/min)	180	180	180	180	180	180	180	
	≤ 425 Bhn or ≤ 45 HRc	17	RPM	5332	2666	1777	1333	889	666	533		
		(13-20)	Fr	0.015	0.030	0.044	0.059	0.089	0.119	0.148		
			Feed (mm/min)	79	79	79	79	79	79	79		
	M	ALLOY STEELS 4140, 4150, 4320, 5120, 5150, 8630, 86L20, 50100	≤ 275 Bhn or ≤ 28 HRc	35	RPM	11148	5574	3716	2787	1858	1394	1115
				(28-42)	Fr	0.024	0.048	0.072	0.096	0.144	0.192	0.240
					Feed (mm/min)	268	268	268	268	268	268	268
≤ 375 Bhn or ≤ 40 HRc			21	RPM	6786	3393	2262	1696	1131	848	679	
			(17-26)	Fr	0.024	0.048	0.072	0.096	0.144	0.192	0.240	
				Feed (mm/min)	163	163	163	163	163	163	163	
≤ 450 Bhn or ≤ 48 HRc		14	RPM	4362	2181	1454	1091	727	545	436		
		(11-16)	Fr	0.015	0.030	0.045	0.060	0.089	0.119	0.149		
			Feed (mm/min)	65	65	65	65	65	65	65		
STAINLESS STEELS (FREE MACHINING) 303, 416, 420F, 430F 440F		≤ 250 Bhn or ≤ 24 HRc	23	RPM	7271	3635	2424	1818	1212	909	727	
			(18-27)	Fr	0.015	0.030	0.045	0.059	0.089	0.119	0.149	
				Feed (mm/min)	108	108	108	108	108	108	108	
	≤ 330 Bhn or ≤ 36 HRc	17	RPM	5332	2666	1777	1333	889	666	533		
		(13-20)	Fr	0.012	0.024	0.036	0.048	0.072	0.096	0.120		
			Feed (mm/min)	64	64	64	64	64	64	64		
STAINLESS STEELS (DIFFICULT) 304, 316, 321, 13-8 PH, 15-5PH, 17-4 PH, Custom 450	≤ 275 Bhn or ≤ 28 HRc	11	RPM	3393	1696	1131	848	565	424	339		
		(9-13)	Fr	0.015	0.029	0.044	0.059	0.088	0.118	0.147		
			Feed (mm/min)	50	50	50	50	50	50	50		
	≤ 375 Bhn or ≤ 40 HRc	8	RPM	2424	1212	808	606	404	303	242		
		(6-9)	Fr	0.010	0.020	0.030	0.040	0.059	0.079	0.099		
			Feed (mm/min)	24	24	24	24	24	24	24		
K	≤ 220 Bhn or ≤ 19 HRc	38	RPM	12118	6059	4039	3029	2020	1515	1212		
		(30-46)	Fr	0.032	0.064	0.097	0.129	0.193	0.257	0.322		
			Feed (mm/min)	390	390	390	390	390	390	390		
	≤ 330 Bhn or ≤ 36 HRc	29	RPM	9209	4605	3070	2302	1535	1151	921		
		(23-35)	Fr	0.032	0.064	0.096	0.128	0.192	0.256	0.320		
			Feed (mm/min)	295	295	295	295	295	295	295		

continued on next page

Straight Flute Reamer

Series 201M Metric	Hardness	Vc (m/min)		DC • mm						
				1	2	3	4	6	8	10
N	ALUMINUM ALLOYS 2017, 2024, 356, 6061, 7075	82	RPM	26174	13087	8725	6544	4362	3272	2617
			Fr	0.040	0.080	0.120	0.160	0.240	0.320	0.400
			Feed (mm/min)	1047	1047	1047	1047	1047	1047	1047
		(66-99)	RPM	22297	11148	7432	5574	3716	2787	2230
			Fr	0.040	0.080	0.120	0.160	0.240	0.320	0.400
			Feed (mm/min)	892	892	892	892	892	892	892
	COPPER ALLOYS Alum Bronze, C110, Muntz Brass	35	RPM	11148	5574	3716	2787	1858	1394	1115
			Fr	0.020	0.041	0.061	0.081	0.122	0.163	0.204
			Feed (mm/min)	227	227	227	227	227	227	227
		(28-42)	RPM	9209	4605	3070	2302	1535	1151	921
			Fr	0.020	0.041	0.061	0.082	0.122	0.163	0.204
			Feed (mm/min)	188	188	188	188	188	188	188
S	SUPER ALLOYS (NICKEL, COBALT, IRON BASE) Inconel 601, 617, 625, Incoloy 800, Monel 400, Rene, Waspaloy	6	RPM	1939	969	646	485	323	242	194
			Fr	0.012	0.024	0.036	0.047	0.071	0.095	0.119
			Feed (mm/min)	23	23	23	23	23	23	23
		(5-7)	RPM	1454	727	485	364	242	182	145
			Fr	0.010	0.021	0.031	0.041	0.062	0.083	0.103
			Feed (mm/min)	15	15	15	15	15	15	15
	3	RPM	969	485	323	242	162	121	97	
		Fr	0.006	0.012	0.019	0.025	0.037	0.050	0.062	
		Feed (mm/min)	6	6	6	6	6	6	6	
	TITANIUM ALLOYS Pure Titanium, Ti6Al4V, Ti6Al2Sn4Zr2Mo, Ti4Al4Mo2Sn0.5Si, Ti-6Al4V	14	RPM	4362	2181	1454	1091	727	545	436
			Fr	0.024	0.048	0.072	0.096	0.144	0.193	0.241
			Feed (mm/min)	105	105	105	105	105	105	105
(11-16)		RPM	3393	1696	1131	848	565	424	339	
		Fr	0.015	0.029	0.044	0.059	0.088	0.118	0.147	
		Feed (mm/min)	50	50	50	50	50	50	50	
11	RPM	2424	1212	808	606	404	303	242		
	Fr	0.010	0.020	0.030	0.040	0.059	0.079	0.099		
	Feed (mm/min)	24	24	24	24	24	24	24		
(9-13)	RPM	2424	1212	808	606	404	303	242		
	Fr	0.010	0.020	0.030	0.040	0.059	0.079	0.099		
	Feed (mm/min)	24	24	24	24	24	24	24		
8	RPM	2424	1212	808	606	404	303	242		
	Fr	0.010	0.020	0.030	0.040	0.059	0.079	0.099		
	Feed (mm/min)	24	24	24	24	24	24	24		
(6-9)	RPM	2424	1212	808	606	404	303	242		
	Fr	0.010	0.020	0.030	0.040	0.059	0.079	0.099		
	Feed (mm/min)	24	24	24	24	24	24	24		

continued on next page

Straight Flute Reamer

Series 201M Metric	Hardness	Vc (m/min)	DC • mm							
			1	2	3	4	6	8	10	
H TOOL STEELS A2, D2, H13, L2, M2, P20, S7, T15, W2	≤ 250 Bhn or ≤ 24 HRc	12	RPM	3878	1939	1293	969	646	485	388
		(10-15)	Fr	0.015	0.031	0.046	0.062	0.093	0.124	0.155
			Feed (mm/min)	60	60	60	60	60	60	60
	≤ 375 Bhn or ≤ 40 HRc	8	RPM	2424	1212	808	606	404	303	242
		(6-9)	Fr	0.010	0.020	0.030	0.040	0.059	0.079	0.099
			Feed (mm/min)	24	24	24	24	24	24	24
	≤ 475 Bhn or ≤ 50 HRc	6	RPM	1939	969	646	485	323	242	194
		(5-7)	Fr	0.006	0.012	0.019	0.025	0.037	0.050	0.062
			Feed (mm/min)	12	12	12	12	12	12	12
	≤ 655 Bhn or ≤ 60 HRc	4	RPM	1272	636	424	318	212	159	127
		(3-5)	Fr	0.006	0.013	0.019	0.025	0.038	0.050	0.063
			Feed (mm/min)	8	8	8	8	8	8	8

Bhn (Brinell) HRc (Rockwell C) HRb (Rockwell B)
 $rpm = (Vc \times 1000) / (DC \times 3.14)$
 $mm/min = Fr \times rpm$
 increase speed and feed 30 percent when using coated reamers
 reduce speed and feed for materials harder than listed
 refer to the SGS Tool Wizard® for complete technical information (www.kyocera-sgstool.com)

Routers



Routing

HIGH PERFORMANCE ROUTERS	SERIES	DESCRIPTION	PAGE
Carbon Composite	20-CCR	Multi-Flute Carbon Composite Fractional	338
	20M-CCR	Multi-Flute Carbon Composite Metric	338
	20-CCR-LHC	Multi-Flute Carbon Composite Left Hand Cut Fractional	339
	20M-CCR-LHC	Multi-Flute Carbon Composite Left Hand Cut Metric	339
Coarse Cut Carbon Composite	31-CCR	Multi-Flute Coarse Composite Fractional	342
	31M-CCR	Multi-Flute Coarse Composite Metric	342
Compression	25	Multi-Flute Compression Fractional	345
	25M	Multi-Flute Compression Metric	345
GENERAL PURPOSE ROUTERS	SERIES	DESCRIPTION	PAGE
Up Cut	21	2 Flute Up Cut Fractional	348
	21M	2 Flute Up Cut Metric	348
Down Cut	22	2 Flute Down Cut Fractional	349
	22M	2 Flute Down Cut Metric	349

Speed & Feed Recommendations listed after each series

Ranurado

RANURADORES DE ALTO RENDIMIENTO	SERIE	DESCRIPCIÓN	PÁGINA
Compuesto de carbono	20-CCR	Filo múltiple, compuesto de carbono, fraccional	338
	20M-CCR	Filo múltiple, compuesto de carbono, métrico	338
	20-CCR-LHC	Filo múltiple, carbon composite corte hélice izquierda fraccional	339
	20M-CCR-LHC	Filo múltiple, carbon composite corte hélice izquierda métrico	339
Compuesto de carbono de corte grueso	31-CCR	Filo múltiple, compuesto grueso, fraccional	342
	31M-CCR	Filo múltiple, compuesto grueso, métrico	342
Compresión	25	Filo múltiple, compresión, fraccional	345
	25M	Filo múltiple, compresión, métrico	345

RANURADORES DE USO GENERAL	SERIE	DESCRIPCIÓN	PÁGINA
Corte ascendente	21	2 filos, corte ascendente, fraccional	348
	21M	2 filos, corte ascendente, métrico	348
Corte descendente	22	2 filos, corte descendente, fraccional	349
	22M	2 filos, corte descendente, métrico	349

Recomendaciones de velocidades y avances mostradas tras cada serie

Détourage

FRAISES A DETOURER HAUTE PERFORMANCE	SÈRIES	DESCRIPTION	PAGE
Composites carbone	20-CCR	Multi-dents pour composites carbone (fractionnel)	338
	20M-CCR	Multi-dents pour composites carbone (métrique)	338
	20-CCR-LHC	Multi-dents carbon composite coupe à gauche (fractionnel)	339
	20M-CCR-LHC	Multi-dents carbon composite coupe à gauche (métrique)	339
Pour composites carbone coupe grossière	31-CCR	Multi-dents pour composites grossiers (fractionnel)	342
	31M-CCR	Multi-dents pour composites grossiers (métrique)	342
Compression	25	Multi-dents de compression (fractionnel)	345
	25M	Multi-dents de compression (métrique)	345

FRAISES À DÉTOURER UNIVERSELLES	SÈRIES	DESCRIPTION	PAGE
Coupe ascendante	21	2 dents coupe ascendante (fractionnel)	348
	21M	2 dents coupe ascendante (métrique)	348
Coupe descendante	22	2 dents coupe descendante (fractionnel)	349
	22M	2 dents coupe descendante (métrique)	349

Recommandations de vitesse et avance indiquées après chaque série

HOCHLEISTUNGS-KONTURENFRÄSER	SERIE	BESCHREIBUNG	SEITE
Kohlefaserverbundwerkstoff	20-CCR	Zölliger Konturenfräser für Kohlefaserverbundwerkstoff	338
	20M-CCR	Konturenfräser für Kohlefaserverbundwerkstoff	338
	20-CCR-LHC	Mehrschneider Carbon Composite Links geschnittene zöllig	339
	20M-CCR-LHC	Mehrschneider Carbon Composite Links geschnittene metrisch	339
Grobschnitt Kohlefaserverbundwerkstoff	31-CCR	Zölliger Konturenfräser für Verbundkunststoff	342
	31M-CCR	Konturenfräser für Verbundkunststoff	342
Gegenläufiger Drall	25	Zölliger Gegenläufiger Konturenfräser	345
	25M	Gegenläufiger Konturenfräser	345

STANDARD-KONTURENFRÄSER	SERIE	BESCHREIBUNG	SEITE
Rechtsspirale	21	Zölliger VHM-Fräser mit 2 Schneiden (ziehend)	348
	21M	VHM-Fräser mit 2 Schneiden (ziehend)	348
Linksspirale	22	Zölliger VHM-Fräser mit 2 Schneiden (drückend)	349
	22M	VHM-Fräser mit 2 Schneiden (drückend)	349

Empfehlungen für Drehzahl & Vorschub im Anhang zu jeder Serie

Carbon Composite



20-CCR FRACTIONAL SERIES

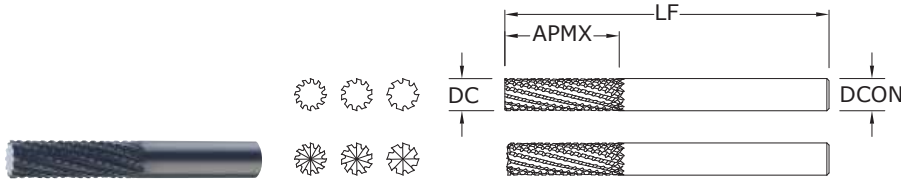

- Multi-flute design and positive geometry to shear with minimal pressure and delamination
- Unique clearance grind minimizes contact between tool diameter and workpiece eliminating friction
- Left hand flutes engineered to control the fibers within CFRP, preventing excessive fiber breakout
- Excels at trimming and profiling difficult and abrasive fiber filled plastics

CUTTING DIAMETER DC	LENGTH OF CUT APMX	OVERALL LENGTH LF	SHANK DIAMETER DCON	NO. OF FLUTES	END STYLE	EDP NO.	
						UNCOATED	Di-NAMITE® (Diamond)
1/4	1	2-1/2	1/4	8	No End Cutting	72930	73013
1/4	1	2-1/2	1/4	8	End Cutting	72947	73012
5/16	1	2-1/2	5/16	10	No End Cutting	72948	73026
5/16	1	2-1/2	5/16	10	End Cutting	72949	73014
3/8	1-1/8	2-1/2	3/8	12	No End Cutting	72950	73028
3/8	1-1/8	2-1/2	3/8	12	End Cutting	72951	73027
1/2	1-1/2	3-1/2	1/2	12	No End Cutting	72952	73041
1/2	1-1/2	3-1/2	1/2	12	End Cutting	72953	73029

TOLERANCES (inch)

DC = +.000/- .005

DCON = h₆

PLASTICS/COMPOSITES

For patent information visit www.ksptpatents.com

20M-CCR METRIC SERIES

- Multi-flute design and positive geometry to shear with minimal pressure and delamination
- Unique clearance grind minimizes contact between tool diameter and workpiece eliminating friction
- Left hand flutes engineered to control the fibers within CFRP, preventing excessive fiber breakout
- Excels at trimming and profiling difficult and abrasive fiber filled plastics

CUTTING DIAMETER DC	LENGTH OF CUT APMX	OVERALL LENGTH LF	SHANK DIAMETER DCON	NO. OF FLUTES	END STYLE	EDP NO.		
						UNCOATED	Ti-NAMITE-B (TiB ₂)	Di-NAMITE® (Diamond)
2,0	6,0	38,0	3,0	5	End Cutting	82930	83100	83070
3,0	10,0	38,0	3,0	5	End Cutting	82931	83101	83071
4,0	12,0	50,0	4,0	5	End Cutting	82932	83102	83072
5,0	15,0	50,0	6,0	5	End Cutting	82933	83103	83073
6,0	25,0	63,0	6,0	8	No End Cutting	82966	83104	83027
6,0	25,0	63,0	6,0	8	End Cutting	82967	83105	83026
8,0	25,0	63,0	8,0	10	No End Cutting	82968	83106	83029
8,0	25,0	63,0	8,0	10	End Cutting	82969	83107	83028
10,0	28,0	63,0	10,0	12	No End Cutting	82970	83108	83042
10,0	28,0	63,0	10,0	12	End Cutting	82971	83109	83041
12,0	38,0	89,0	12,0	12	No End Cutting	82972	83110	83044
12,0	38,0	89,0	12,0	12	End Cutting	82973	83111	83043

TOLERANCES (mm)

DC = +0,000/-0,130

DCON = h₆

PLASTICS/COMPOSITES

For patent information visit www.ksptpatents.com



FRACTIONAL & METRIC Carbon Composite



20-CCR-LHC FRACTIONAL SERIES

TOLERANCES (inch)

DC = +.000/-0.005

DCON = h₆

PLASTICS/COMPOSITES

For patent information visit www.ksptpatents.com

CUTTING DIAMETER DC	LENGTH OF CUT APMX	OVERALL LENGTH LF	SHANK DIAMETER DCON	NO. OF FLUTES	END STYLE	EDP NO.	
						UNCOATED	Di-NAMITE® (Diamond)
1/4	1	2-1/2	1/4	8	No End Cutting	73070	73078
1/4	1	2-1/2	1/4	8	End Cutting	73071	73079
5/16	1	2-1/2	5/16	10	No End Cutting	73072	73080
5/16	1	2-1/2	5/16	10	End Cutting	73073	73081
3/8	1-1/8	2-1/2	3/8	12	No End Cutting	73074	73082
3/8	1-1/8	2-1/2	3/8	12	End Cutting	73075	73083

- Multi-flute design and positive geometry to shear with minimal pressure and delamination
- Unique clearance grind minimizes contact between tool diameter and workpiece eliminating friction
- Left hand flutes engineered to control the fibers within CFRP, preventing excessive fiber breakout
- Excels at trimming and profiling difficult and abrasive fiber filled plastics

20M-CCR-LHC METRIC SERIES

TOLERANCES (mm)

DC = +0,000/-0,130

DCON = h₆

PLASTICS/COMPOSITES

For patent information visit www.ksptpatents.com

CUTTING DIAMETER DC	LENGTH OF CUT APMX	OVERALL LENGTH LF	SHANK DIAMETER DCON	NO. OF FLUTES	END STYLE	EDP NO.	
						UNCOATED	Di-NAMITE® (Diamond)
6,0	25,0	63,0	6,0	8	No End Cutting	83220	83230
6,0	25,0	63,0	6,0	8	End Cutting	83221	83231
8,0	25,0	63,0	8,0	10	No End Cutting	83222	83232
8,0	25,0	63,0	8,0	10	End Cutting	83223	83233
10,0	28,0	63,0	10,0	12	No End Cutting	83224	83234
10,0	28,0	63,0	10,0	12	End Cutting	83225	83235

- Multi-flute design and positive geometry to shear with minimal pressure and delamination
- Unique clearance grind minimizes contact between tool diameter and workpiece eliminating friction
- Left hand flutes engineered to control the fibers within CFRP, preventing excessive fiber breakout
- Excels at trimming and profiling difficult and abrasive fiber filled plastics

Carbon Composite

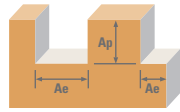

Series 20 Fractional	Ae x DC	Ap x DC	Vc (sfm)	DC • in					
				1/4	5/16	3/8	1/2		
CFRP, AFRP (CARBON FIBER, ARAMID FIBER)	Slot 	1	≤ 1	400 (320-480)	RPM	6112	4890	4075	3056
					Fr	0.0049	0.0094	0.0135	0.0180
					Feed (ipm)	30	46	55	55
	Profile 	≤ 0.5	≤ 1.5	500 (400-600)	RPM	7640	6112	5093	3820
					Fr	0.0049	0.0094	0.0135	0.0180
					Feed (ipm)	38	58	69	69
	HSM 	≤ 0.05	≤ 2	825 (660-990)	RPM	12606	10085	8404	6303
					Fr	0.0111	0.0215	0.0309	0.0413
					Feed (ipm)	140	217	260	260
GFRP (FIBERGLASS)	Slot 	1	≤ 1	320 (256-384)	RPM	4890	3912	3260	2445
					Fr	0.0049	0.0095	0.0135	0.0180
					Feed (ipm)	24	37	44	44
	Profile 	≤ 0.5	≤ 1.5	400 (320-480)	RPM	6112	4890	4075	3056
					Fr	0.0049	0.0095	0.0135	0.0180
					Feed (ipm)	30	46	55	55
	HSM 	≤ 0.05	≤ 2	660 (528-792)	RPM	10085	8068	6723	5042
					Fr	0.0110	0.0214	0.0311	0.0414
					Feed (ipm)	111	173	209	209
CARBON, GRAPHITE	Slot 	1	≤ 1	480 (384-576)	RPM	7334	5868	4890	3667
					Fr	0.0064	0.0124	0.0180	0.0240
					Feed (ipm)	47	73	88	88
	Profile 	≤ 0.5	≤ 1.5	600 (480-720)	RPM	9168	7334	6112	4584
					Fr	0.0064	0.0124	0.0180	0.0240
					Feed (ipm)	59	91	110	110
	HSM 	≤ 0.05	≤ 2	990 (792-1188)	RPM	15127	12102	10085	7564
					Fr	0.0147	0.0287	0.0412	0.0549
					Feed (ipm)	223	347	415	415
PLASTICS	Slot 	1	≤ 1	665 (640-690)	RPM	10161	8129	6774	5081
					Fr	0.0077	0.0150	0.0217	0.0241
					Feed (ipm)	78	122	147	147
	Profile 	≤ 0.5	≤ 1.5	1000 (800-1200)	RPM	15280	12224	10187	7640
					Fr	0.0077	0.0150	0.0217	0.0241
					Feed (ipm)	118	183	221	184
	HSM 	≤ 0.05	≤ 2	1650 (1320-1980)	RPM	25212	20170	16808	12606
					Fr	0.0147	0.0287	0.0413	0.0551
					Feed (ipm)	370	579	694	694

HSM (high speed machining)
 $rpm = Vc \times 3.82 / DC$
 $ipm = Fr \times rpm$
 adjust parameters based on resin type and fiber structure
 reduce speed when overheating causes melting or damage to resin
 reduce feed if delamination or fraying occur

finish cuts typically required reduced feed and cutting depths
 rates shown are for use without coolant; rates may be increased with coolant
 dust collection is vital when machining dry
 diamond coating will increase tool life in graphite and composite materials
 refer to the SGS Tool Wizard® for complete technical information
 (www.kyocera-sgstool.com)

Carbon Composite

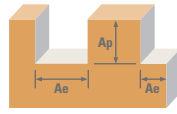

Series 20M Metric	Ae x DC	Ap x DC	Vc (m/min)	DC • mm						
				3	6	8	10	12		
CFRP, AFRP (CARBON FIBER, ARAMID FIBER)	Slot 	1	≤ 1	120 (96-164)	RPM	12722	6361	4771	3817	3181
					Fr	0.055	0.113	0.243	0.366	0.439
					Feed (mm/min)	700	720	1160	1395	1395
	Profile 	≤ 0.5	≤ 1.5	150 (120-180)	RPM	15903	7951	5963	4771	3976
					Fr	0.055	0.113	0.243	0.366	0.439
					Feed (mm/min)	875	900	1450	1744	1744
	HSM 	≤ 0.05	≤ 2	250 (200-300)	RPM	26504	13252	9939	7951	6626
					Fr	0.126	0.260	0.556	0.833	1.000
					Feed (mm/min)	3350	3450	5527	6625	6625
GFRP (FIBERGLASS)	Slot 	1	≤ 1	100 (80-120)	RPM	10602	5301	3976	3181	2650
					Fr	0.054	0.111	0.236	0.357	0.428
					Feed (mm/min)	570	587	940	1135	1135
	Profile 	≤ 0.5	≤ 1.5	120 (96-164)	RPM	12722	6361	4771	3817	3181
					Fr	0.054	0.111	0.236	0.357	0.428
					Feed (mm/min)	684	704	1128	1362	1362
	HSM 	≤ 0.05	≤ 2	200 (160-240)	RPM	21203	10602	7951	6361	5301
					Fr	0.124	0.261	0.557	1.011	1.213
					Feed (mm/min)	2629	2765	4430	6430	6430
CARBON, GRAPHITE	Slot 	1	≤ 1	145 (116-174)	RPM	15372	7686	5765	4612	3843
					Fr	0.069	0.152	0.323	0.482	0.579
					Feed (mm/min)	1061	1165	1860	2224	2224
	Profile 	≤ 0.5	≤ 1.5	185 (148-222)	RPM	19613	9807	7355	5884	4903
					Fr	0.069	0.152	0.323	0.482	0.579
					Feed (mm/min)	1353	1486	2373	2838	2838
	HSM 	≤ 0.05	≤ 2	300 (240-360)	RPM	31805	15903	11927	9542	7951
					Fr	0.159	0.348	0.740	1.109	1.331
					Feed (mm/min)	5057	5535	8820	10580	10580
PLASTICS	Slot 	1	≤ 1	245 (196-294)	RPM	25974	12987	9740	7792	6494
					Fr	0.069	0.150	0.319	0.477	0.572
					Feed (mm/min)	1792	1945	3107	3717	3717
	Profile 	≤ 0.5	≤ 1.5	305 (244-366)	RPM	32335	16168	12126	9701	8084
					Fr	0.069	0.150	0.319	0.477	0.572
					Feed (mm/min)	2231	2421	3868	4627	4627
	HSM 	≤ 0.05	≤ 2	505 (404-606)	RPM	53538	26769	20077	16062	13385
					Fr	0.159	0.344	0.732	1.097	1.316
					Feed (mm/min)	8513	9220	14690	17617	17617

HSM (high speed machining)
 $rpm = (Vc \times 1000) / (DC \times 3.14)$
 $mm/min = Fr \times rpm$
 adjust parameters based on resin type and fiber structure
 reduce speed when overheating causes melting or damage to resin
 reduce feed if delamination or fraying occur

finish cuts typically required reduced feed and cutting depths
 rates shown are for use without coolant; rates may be increased with coolant
 dust collection is vital when machining dry
 diamond coating will increase tool life in graphite and composite materials
 refer to the SGS Tool Wizard® for complete technical information
 (www.kyocera-sgstool.com)

Coarse Cut Carbon Composite



31-CCR FRACTIONAL SERIES

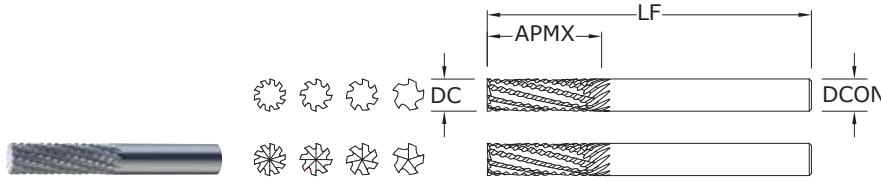

- Fewer, deeper flutes to prevent clogging in heavy routing
- Unique clearance grind minimizes contact between tool diameter and workpiece eliminating friction
- Left hand flutes engineered to control the fibers within CFRP, preventing excessive fiber breakout
- Excels at trimming and profiling difficult and abrasive fiber filled plastics

inch						EDP NO.	
CUTTING DIAMETER DC	LENGTH OF CUT APMX	OVERALL LENGTH LF	SHANK DIAMETER DCON	NO. OF FLUTES	END STYLE	UNCOATED	Di-NAMITE® (Diamond)
1/4	1	2-1/2	1/4	5	End Cutting	72954	72955
1/4	1	2-1/2	1/4	5	No End Cutting	72956	72957
5/16	1	2-1/2	5/16	7	End Cutting	72958	72959
5/16	1	2-1/2	5/16	7	No End Cutting	72960	72961
3/8	1-1/8	2-1/2	3/8	8	End Cutting	72962	72963
3/8	1-1/8	2-1/2	3/8	8	No End Cutting	72964	72965
1/2	1-1/2	3-1/2	1/2	10	End Cutting	72966	72967
1/2	1-1/2	3-1/2	1/2	10	No End Cutting	72968	72969

TOLERANCES (inch)

DC = +.000/- .005
DCON = h₆

PLASTICS/COMPOSITES

For patent information visit www.ksptpatents.com

31M-CCR METRIC SERIES

- Fewer, deeper flutes to prevent clogging in heavy routing
- Unique clearance grind minimizes contact between tool diameter and workpiece eliminating friction
- Left hand flutes engineered to control the fibers within CFRP, preventing excessive fiber breakout
- Excels at trimming and profiling difficult and abrasive fiber filled plastics

mm						EDP NO.		
CUTTING DIAMETER DC	LENGTH OF CUT APMX	OVERALL LENGTH LF	SHANK DIAMETER DCON	NO. OF FLUTES	END STYLE	UNCOATED	Ti-NAMITE-B (TiB ₂)	Di-NAMITE® (Diamond)
6,0	25,0	63,0	6,0	5	End Cutting	82974	83200	82982
6,0	25,0	63,0	6,0	5	No End Cutting	82975	83201	82983
8,0	25,0	63,0	8,0	7	End Cutting	82976	83202	82984
8,0	25,0	63,0	8,0	7	No End Cutting	82977	83203	82985
10,0	28,0	63,0	10,0	8	End Cutting	82978	83204	82986
10,0	28,0	63,0	10,0	8	No End Cutting	82979	83205	82987
12,0	38,0	89,0	12,0	10	End Cutting	82980	83206	82988
12,0	38,0	89,0	12,0	10	No End Cutting	82981	83207	82989

TOLERANCES (mm)

DC = +0,000/-0,130
DCON = h₆

PLASTICS/COMPOSITES

For patent information visit www.ksptpatents.com

Coarse Cut Carbon Composite

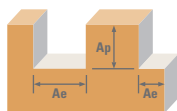

Series 31 Fractional	Ae x DC	Ap x DC	Vc (sfm)	DC • in					
				1/4	5/16	3/8	1/2		
CFRP, AFRP (CARBON FIBER, ARAMID FIBER)	Slot 	1	≤ 1	400	RPM	6112	4890	4075	3056
				(320-480)	Fr	0.0029	0.0065	0.0088	0.0147
					Feed (ipm)	18	32	36	45
	Profile 	≤ 0.5	≤ 1.5	500	RPM	7640	6112	5093	3820
				(400-600)	Fr	0.0029	0.0065	0.0088	0.0147
					Feed (ipm)	23	40	45	56
	HSM 	≤ 0.05	≤ 2	825	RPM	12606	10085	8404	6303
				(660-990)	Fr	0.0069	0.0151	0.0206	0.0344
					Feed (ipm)	87	152	173	217
GFRP (FIBERGLASS)	Slot 	1	≤ 1	320	RPM	4890	3912	3260	2445
				(256-384)	Fr	0.0031	0.0066	0.0089	0.0147
					Feed (ipm)	15	26	29	36
	Profile 	≤ 0.5	≤ 1.5	400	RPM	6112	4890	4075	3056
				(320-480)	Fr	0.0031	0.0066	0.0089	0.0147
					Feed (ipm)	19	33	36	45
	HSM 	≤ 0.05	≤ 2	660	RPM	10085	8068	6723	5042
				(528-792)	Fr	0.0069	0.0150	0.0205	0.0343
					Feed (ipm)	70	121	138	173
CARBON, GRAPHITE	Slot 	1	≤ 1	480	RPM	7334	5868	4890	3667
				(384-576)	Fr	0.0040	0.0087	0.0119	0.0199
					Feed (ipm)	29	51	58	73
	Profile 	≤ 0.5	≤ 1.5	600	RPM	9168	7334	6112	4584
				(480-720)	Fr	0.0040	0.0087	0.0119	0.0199
					Feed (ipm)	36	64	73	91
	HSM 	≤ 0.05	≤ 2	990	RPM	15127	12102	10085	7564
				(792-1188)	Fr	0.0092	0.0201	0.0275	0.0459
					Feed (ipm)	139	243	277	347
PLASTICS	Slot 	1	≤ 1	800	RPM	12224	9779	8149	6112
				(640-690)	Fr	0.0040	0.0087	0.0119	0.0200
					Feed (ipm)	49	85	97	122
	Profile 	≤ 0.5	≤ 1.5	1000	RPM	15280	12224	10187	7640
				(800-1200)	Fr	0.0040	0.0087	0.0119	0.0200
					Feed (ipm)	61	106	121	153
	HSM 	≤ 0.05	≤ 2	1650	RPM	25212	20170	16808	12606
				(1320-1980)	Fr	0.0092	0.0201	0.0275	0.0459
					Feed (ipm)	232	405	462	578

HSM (high speed machining)
 $rpm = Vc \times 3.82 / DC$
 $ipm = Fr \times rpm$
 adjust parameters based on resin type and fiber structure
 reduce speed when overheating causes melting or damage to resin
 reduce feed if delamination or fraying occur

finish cuts typically required reduced feed and cutting depths
 rates shown are for use without coolant; rates may be increased with coolant
 dust collection is vital when machining dry
 diamond coating will increase tool life in graphite and composite materials
 refer to the SGS Tool Wizard® for complete technical information
 (www.kyocera-sgtool.com)

Coarse Cut Carbon Composite

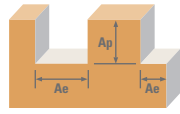

Series 31M Metric	Ae x DC	Ap x DC	Vc (m/min)	DC • mm					
				6	8	10	12		
CFRP, AFRP (CARBON FIBER, ARAMID FIBER)	Slot 	1	≤ 1	120	RPM	6361	4771	3817	3181
				(96-164)	Fr	0.071	0.170	0.244	0.366
					Feed (mm/min)	450	810	930	1165
	Profile 	≤ 0.5	≤ 1.5	150	RPM	7951	5963	4771	3976
				(120-180)	Fr	0.071	0.170	0.244	0.366
					Feed (mm/min)	563	1013	1163	1456
	HSM 	≤ 0.05	≤ 2	250	RPM	13252	9939	7951	6626
				(200-300)	Fr	0.162	0.388	0.555	0.832
					Feed (mm/min)	2150	3860	4415	5515
GFRP (FIBERGLASS)	Slot 	1	≤ 1	100	RPM	5301	3976	3181	2650
				(80-120)	Fr	0.069	0.165	0.237	0.357
					Feed (mm/min)	365	655	755	945
	Profile 	≤ 0.5	≤ 1.5	120	RPM	6361	4771	3817	3181
				(96-164)	Fr	0.069	0.165	0.237	0.357
					Feed (mm/min)	438	786	906	1134
	HSM 	≤ 0.05	≤ 2	200	RPM	10602	7951	6361	5301
				(160-240)	Fr	0.163	0.390	0.557	0.834
					Feed (mm/min)	1725	3100	3540	4420
CARBON, GRAPHITE	Slot 	1	≤ 1	145	RPM	7686	5765	4612	3843
				(116-174)	Fr	0.095	0.226	0.321	0.483
					Feed (mm/min)	728	1300	1480	1855
	Profile 	≤ 0.5	≤ 1.5	185	RPM	9807	7355	5884	4903
				(148-222)	Fr	0.095	0.226	0.321	0.483
					Feed (mm/min)	929	1659	1888	2367
	HSM 	≤ 0.05	≤ 2	300	RPM	15903	11927	9542	7951
				(240-360)	Fr	0.217	0.517	0.739	1.111
					Feed (mm/min)	3450	6170	7050	8830
PLASTICS	Slot 	1	≤ 1	245	RPM	12987	9740	7792	6494
				(196-294)	Fr	0.094	0.223	0.318	0.477
					Feed (mm/min)	1215	2175	2475	3100
	Profile 	≤ 0.5	≤ 1.5	305	RPM	16168	12126	9701	8084
				(244-366)	Fr	0.094	0.223	0.318	0.477
					Feed (mm/min)	1513	2708	3081	3859
	HSM 	≤ 0.05	≤ 2	505	RPM	26769	20077	16062	13385
				(404-606)	Fr	0.215	0.512	0.731	1.098
					Feed (mm/min)	5760	10280	11745	14700

HSM (high speed machining)
 $rpm = (Vc \times 1000) / (DC \times 3.14)$
 $mm/min = Fr \times rpm$
 adjust parameters based on resin type and fiber structure
 reduce speed when overheating causes melting or damage to resin
 reduce feed if delamination or fraying occur

finish cuts typically required reduced feed and cutting depths
 rates shown are for use without coolant; rates may be increased with coolant
 dust collection is vital when machining dry
 diamond coating will increase tool life in graphite and composite materials
 refer to the SGS Tool Wizard® for complete technical information
 (www.kyocera-sgstool.com)

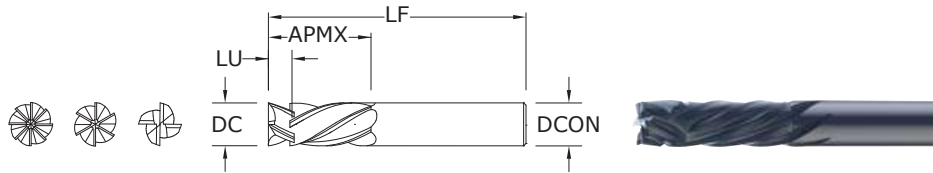

25
FRACTIONAL SERIES

TOLERANCES (inch)

DC = +.000/- .003
DCON = h₆

PLASTICS/COMPOSITES

For patent information visit
www.ksptpatents.com

CUTTING DIAMETER DC	LENGTH OF CUT APMX	inch				NO. OF FLUTES	EDP NO.	
		OVERALL LENGTH LF	SHANK DIAMETER DCON	INTERSECT LENGTH LU	UNCOATED		Di-NAMITE® (Diamond)	
1/4	1	2-1/2	1/4	11/64	4	72970	72971	
5/16	1	2-1/2	5/16	7/32	4	72972	72973	
3/8	1-1/8	2-1/2	3/8	17/64	6	72974	72975	
1/2	1-1/2	3-1/2	1/2	23/64	8	72976	72977	

- Compression-style helixes direct cutting forces inward, eliminating fiber breakout and delamination
- Primary/secondary relief grind for reduced friction and pressure
- Rigid, heavy core

TOLERANCES (mm)

DC = +0,000/-0,080
DCON = h₆

PLASTICS/COMPOSITES

For patent information visit
www.ksptpatents.com

CUTTING DIAMETER DC	LENGTH OF CUT APMX	mm				NO. OF FLUTES	EDP NO.	
		OVERALL LENGTH LF	SHANK DIAMETER DCON	INTERSECT LENGTH LU	UNCOATED		Di-NAMITE® (Diamond)	
6,0	25,0	63,0	6,0	4,10	4	82990	82991	
8,0	25,0	63,0	8,0	5,58	4	82992	82993	
10,0	28,0	63,0	10,0	7,05	6	82994	82995	
12,0	38,0	89,0	12,0	8,60	8	82996	82997	

25M
METRIC SERIES

- Compression-style helixes direct cutting forces inward, eliminating fiber breakout and delamination
- Primary/secondary relief grind for reduced friction and pressure
- Rigid, heavy core

Compression

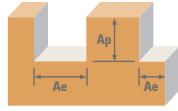

Series 25 Fractional	Ae x DC	Ap x DC	Vc (sfm)	DC • in					
				1/4	5/16	3/8	1/2		
CFRP, AFRP (CARBON FIBER, ARAMID FIBER)	Profile 	≤ 0.5	≤ 1.5	500	RPM	7640	6112	5093	3820
				(400-600)	Fz	0.0016	0.0030	0.0040	0.0048
				Feed (ipm)	49	73	122	147	
	HSM 	≤ 0.05	≤ 2	825	RPM	12606	10085	8404	6303
				(660-990)	Fz	0.0037	0.0069	0.0092	0.0110
				Feed (ipm)	187	278	464	555	
GFRP (FIBERGLASS)	Profile 	≤ 0.5	≤ 1.5	400	RPM	6112	4890	4075	3056
				(320-480)	Fz	0.0016	0.0030	0.0040	0.0048
				Feed (ipm)	39	59	98	117	
	HSM 	≤ 0.05	≤ 2	660	RPM	10085	8068	6723	5042
				(528-792)	Fz	0.0037	0.0069	0.0092	0.0110
				Feed (ipm)	149	223	371	444	
N CARBON, GRAPHITE	Profile 	≤ 0.5	≤ 1.5	600	RPM	9168	7334	6112	4584
				(480-720)	Fz	0.0020	0.0038	0.0050	0.0060
				Feed (ipm)	73	111	183	220	
	HSM 	≤ 0.05	≤ 2	990	RPM	15127	12102	10085	7564
				(792-1188)	Fz	0.0046	0.0086	0.0115	0.0138
				Feed (ipm)	278	416	696	835	
PLASTICS	Profile 	≤ 0.5	≤ 1.5	1000	RPM	15280	12224	10187	7640
				(800-1200)	Fz	0.0020	0.0038	0.0050	0.0060
				Feed (ipm)	122	186	306	367	
	HSM 	≤ 0.05	≤ 2	1650	RPM	25212	20170	16808	12606
				(1320-1980)	Fz	0.0046	0.0086	0.0115	0.0138
				Feed (ipm)	464	694	1160	1392	
MACHINABLE CERAMICS MACHINABLE GLASS	Profile 	≤ 0.5	≤ 1.5	50	RPM	764	611	509	382
				(40-60)	Fz	0.0008	0.0015	0.0020	0.0024
				Feed (ipm)	2.4	3.7	6.1	7.3	
	HSM 	≤ 0.05	≤ 2	85	RPM	1299	1039	866	649
				(68-102)	Fz	0.0018	0.0034	0.0046	0.0055
				Feed (ipm)	9.4	14.1	23.9	28.6	

HSM (high speed machining)
 $rpm = Vc \times 3.82 / DC$
 $ipm = Fz \times \text{number of flutes} \times rpm$
 adjust parameters based on resin type and fiber structure
 reduce speed when overheating causes melting or damage to resin
 reduce feed if delamination or fraying occur

finish cuts typically required reduced feed and cutting depths
 rates shown are for use without coolant; rates may be increased with coolant
 dust collection is vital when machining dry
 diamond coating will increase tool life in graphite and composite materials
 refer to the SGS Tool Wizard® for complete technical information
 (www.kyocera-sgstool.com)

Compression

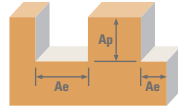

Series 25M Metric	Ae x DC	Ap x DC	Vc (m/min)	DC • mm					
				6	8	10	12		
CFRP, AFRP (CARBON FIBER, ARAMID FIBER)	Profile 	≤ 0.5	≤ 1.5	150	RPM	7951	5963	4771	3976
				(96-164)	Fz	0.040	0.065	0.075	0.100
				Feed (mm/min)	1272	1550	2147	3181	
	HSM 	≤ 0.05	≤ 2	250	RPM	13252	9939	7951	6626
				(200-300)	Fz	0.095	0.145	0.175	0.235
				Feed (mm/min)	5036	5765	8349	12457	
GFRP (FIBERGLASS)	Profile 	≤ 0.5	≤ 1.5	120	RPM	6361	4771	3817	3181
				(96-164)	Fz	0.040	0.065	0.075	0.100
				Feed (mm/min)	1018	1240	1717	2544	
	HSM 	≤ 0.05	≤ 2	200	RPM	10602	7951	6361	5301
				(160-240)	Fz	0.095	0.145	0.175	0.235
				Feed (mm/min)	4029	4612	6679	9966	
N CARBON, GRAPHITE	Profile 	≤ 0.5	≤ 1.5	185	RPM	9807	7355	5884	4903
				(148-222)	Fz	0.050	0.080	0.095	0.125
				Feed (mm/min)	1961	2354	3354	4903	
	HSM 	≤ 0.05	≤ 2	300	RPM	15903	11927	9542	7951
				(240-360)	Fz	0.115	0.185	0.220	0.290
				Feed (mm/min)	7315	8826	12595	18447	
PLASTICS	Profile 	≤ 0.5	≤ 1.5	305	RPM	16168	12126	9701	8084
				(244-366)	Fz	0.050	0.080	0.095	0.125
				Feed (mm/min)	3234	3880	5529	8084	
	HSM 	≤ 0.05	≤ 2	505	RPM	26769	20077	16062	13385
				(404-606)	Fz	0.115	0.185	0.220	0.290
				Feed (mm/min)	12314	14857	21201	31052	
MACHINABLE CERAMICS MACHINABLE GLASS	Profile 	≤ 0.5	≤ 1.5	15	RPM	795	596	477	398
				(12-18)	Fz	0.020	0.035	0.045	0.050
				Feed (mm/min)	64	83	129	159	
	HSM 	≤ 0.05	≤ 2	25	RPM	1325	994	795	663
				(20-30)	Fz	0.045	0.075	0.085	0.115
				Feed (mm/min)	239	298	406	610	

HSM (high speed machining)
 $rpm = (Vc \times 1000) / (DC \times 3.14)$
 $mm/min = Fz \times \text{number of flutes} \times rpm$
 adjust parameters based on resin type and fiber structure
 reduce speed when overheating causes melting or damage to resin
 reduce feed if delamination or fraying occur

finish cuts typically required reduced feed and cutting depths
 rates shown are for use without coolant; rates may be increased with coolant
 dust collection is vital when machining dry
 diamond coating will increase tool life in graphite and composite materials
 refer to the SGS Tool Wizard® for complete technical information
 (www.kyocera-sgstool.com)

Up Cut

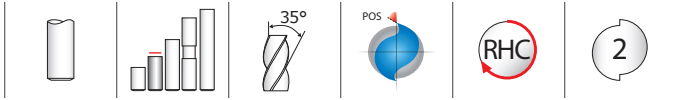

21 FRACTIONAL SERIES

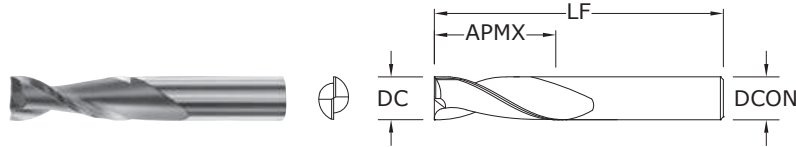

inch				EDP NO.
CUTTING DIAMETER DC	LENGTH OF CUT APMX	OVERALL LENGTH LF	SHANK DIAMETER DCON	UNCOATED
1/8	1/2	2	1/4	90001
5/32	5/8	2-1/2	1/4	90005
3/16	3/4	2-1/2	1/4	90009
1/4	3/4	2-1/2	1/4	90013
1/4	1	2-1/2	1/4	90017
5/16	1	2-1/2	5/16	90021
5/16	1	3	1/2	90025
3/8	1	2-1/2	3/8	90029
3/8	1-1/4	3	1/2	90033
1/2	1-1/4	3	1/2	90037
1/2	1-1/2	3-1/2	1/2	90041
1/2	2	4	1/2	90045
5/8	2	4-1/2	5/8	90049
3/4	2	4-1/2	3/4	90053

TOLERANCES (inch)

DC = +.000/- .003

DCON = h₆

PLASTICS/COMPOSITES

For patent information visit www.ksptpatents.com

21M METRIC SERIES

mm				EDP NO.
CUTTING DIAMETER DC	LENGTH OF CUT APMX	OVERALL LENGTH LF	SHANK DIAMETER DCON	UNCOATED
3,0	13,0	50,0	6,0	90101
4,0	16,0	63,0	6,0	90107
5,0	19,0	63,0	6,0	90109
6,0	25,0	63,0	6,0	90113
8,0	25,0	63,0	8,0	90121
10,0	31,0	75,0	10,0	90129
12,0	31,0	75,0	12,0	90137

TOLERANCES (mm)

DC = +0,000/-0,080

DCON = h₆

PLASTICS/COMPOSITES

For patent information visit www.ksptpatents.com

Down Cut

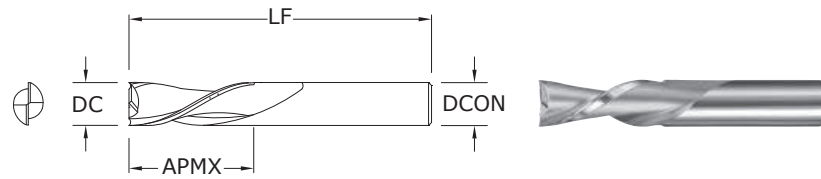
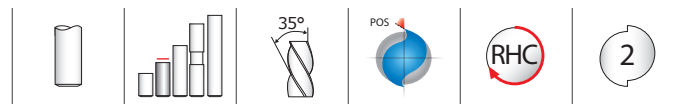

22 FRACTIONAL SERIES

TOLERANCES (inch)

DC = +.000/-0.003
DCON = h₆

PLASTICS/COMPOSITES

For patent information visit www.ksptpatents.com

inch				EDP NO.
CUTTING DIAMETER DC	LENGTH OF CUT APMX	OVERALL LENGTH LF	SHANK DIAMETER DCON	UNCOATED
1/8	1/2	2	1/4	91001
5/32	5/8	2-1/2	1/4	91005
3/16	3/4	2-1/2	1/4	91009
1/4	3/4	2-1/2	1/4	91013
1/4	1	2-1/2	1/4	91017
5/16	1	2-1/2	5/16	91021
5/16	1	3	1/2	91025
3/8	1	2-1/2	3/8	91029
3/8	1-1/4	3	1/2	91033
1/2	1-1/4	3	1/2	91037
1/2	1-1/2	3-1/2	1/2	91041
1/2	2	4	1/2	91045
5/8	2	4-1/2	5/8	91049
3/4	2	4-1/2	3/4	91053

22M METRIC SERIES

TOLERANCES (mm)

DC = +0,000/-0,080
DCON = h₆

PLASTICS/COMPOSITES

For patent information visit www.ksptpatents.com

mm				EDP NO.
CUTTING DIAMETER DC	LENGTH OF CUT APMX	OVERALL LENGTH LF	SHANK DIAMETER DCON	UNCOATED
3,0	13,0	50,0	6,0	91101
4,0	16,0	63,0	6,0	91107
5,0	19,0	63,0	6,0	91109
6,0	25,0	63,0	6,0	91113
8,0	25,0	63,0	8,0	91121
10,0	31,0	75,0	10,0	91129
12,0	31,0	75,0	12,0	91137

Up Cut Down Cut

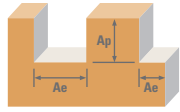

Series 21, 22 Fractional	Ae x DC	Ap x DC	Vc (sfm)		DC • in					
					1/8	1/4	3/8	1/2	3/4	
HARDWOODS	Slot 	1	≤ 1	1550	RPM	47368	23684	15789	11842	7895
				(1240-1860)	Fz	0.0008	0.0015	0.0025	0.0030	0.0045
					Feed (ipm)	76	71	79	71	71
	Profile 	≤ 0.5	≤ 1.5	1550	RPM	47368	23684	15789	11842	7895
				(1240-1860)	Fz	0.0008	0.0015	0.0025	0.0030	0.0045
					Feed (ipm)	76	71	79	71	71
SOFTWOODS	Slot 	1	≤ 1	1950	RPM	59592	29796	19864	14898	9932
				(1560-2340)	Fz	0.0010	0.0020	0.0030	0.0035	0.0055
					Feed (ipm)	119	119	119	104	109
	Profile 	≤ 0.5	≤ 1.5	1950	RPM	59592	29796	19864	14898	9932
				(1560-2340)	Fz	0.0010	0.0020	0.0030	0.0035	0.0055
					Feed (ipm)	119	119	119	104	109
PLYWOODS	Slot 	1	≤ 1	1950	RPM	59592	29796	19864	14898	9932
				(1560-2340)	Fz	0.0013	0.0025	0.0040	0.0050	0.0075
					Feed (ipm)	155	149	159	149	149
	Profile 	≤ 0.5	≤ 1.5	1950	RPM	59592	29796	19864	14898	9932
				(1560-2340)	Fz	0.0013	0.0025	0.0040	0.0050	0.0075
					Feed (ipm)	155	149	159	149	149
N PLASTICS	Slot 	1	≤ 1	1950	RPM	59592	29796	19864	14898	9932
				(1560-2340)	Fz	0.0008	0.0017	0.0025	0.0035	0.0050
					Feed (ipm)	95	101	99	104	99
	Profile 	≤ 0.5	≤ 1.5	1950	RPM	59592	29796	19864	14898	9932
				(1560-2340)	Fz	0.0008	0.0017	0.0025	0.0035	0.0050
					Feed (ipm)	95	101	99	104	99

rpm = Vc x 3.82 / DC
ipm = Fz x 2 x rpm

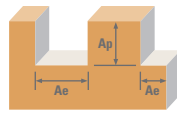

Series 21M, 22M Metric				Vc (m/min)	DC • mm					
		Ae x DC	Ap x DC		3	6	10	12	20	
HARDWOODS	Slot 	1	≤ 1	470	RPM	49828	24914	14948	12457	7474
				(376-564)	Fz	0.020	0.040	0.065	0.075	0.115
				Feed (mm/min)	1993	1993	1943	1869	1719	
	Profile 	≤ 0.5	≤ 1.5	470	RPM	49828	24914	8155	4241	1509
				(376-564)	Fz	0.020	0.040	0.065	0.075	0.115
				Feed (mm/min)	1993	1993	1060	636	347	
SOFTWOODS	Slot 	1	≤ 1	600	RPM	63610	31805	19083	15903	9542
				(480-720)	Fz	0.025	0.050	0.075	0.090	0.140
				Feed (mm/min)	3181	3181	2862	2862	2672	
	Profile 	≤ 0.5	≤ 1.5	600	RPM	63610	31805	19083	15903	303467
				(480-720)	Fz	0.025	0.050	0.075	0.090	0.140
				Feed (mm/min)	3181	3181	2862	2862	84971	
PLYWOODS	Slot 	1	≤ 1	600	RPM	63610	31805	19083	15903	9542
				(480-720)	Fz	0.030	0.065	0.100	0.125	0.190
				Feed (mm/min)	3817	4135	3817	3976	3626	
	Profile 	≤ 0.5	≤ 1.5	600	RPM	63610	31805	19083	15903	303467
				(480-720)	Fz	0.030	0.065	0.100	0.125	0.190
				Feed (mm/min)	3817	4135	3817	3976	115318	
N PLASTICS	Slot 	1	≤ 1	600	RPM	63610	31805	19083	15903	9542
				(480-720)	Fz	0.020	0.040	0.065	0.090	0.125
				Feed (mm/min)	2544	2544	2481	2862	2385	
	Profile 	≤ 0.5	≤ 1.5	600	RPM	63610	31805	19083	15903	9542
				(480-720)	Fz	0.020	0.040	0.065	0.090	0.125
				Feed (mm/min)	2544	2544	2481	2862	2385	

rpm = (Vc x 1000) / (DC x 3.14)
mm/min = Fz x 2 x rpm

EDP Number Index

EDP NO.	PAGE	EDP NO.	PAGE	EDP NO.	PAGE	EDP NO.	PAGE	EDP NO.	PAGE	EDP NO.	PAGE	EDP NO.	PAGE
30000	195	30134	201	30343	177	30473	180	30561	189	30819	189	30925	191
30001	195	30135	196	30344	181	30474	180	30562	191	30820	189	30926	191
30002	195	30136	201	30345	177	30475	180	30563	189	30821	189	30927	191
30003	195	30137	196	30346	181	30476	180	30564	191	30822	189	30928	191
30004	195	30138	201	30347	177	30477	180	30565	189	30823	189	30929	191
30005	195	30139	196	30348	181	30478	180	30566	191	30824	189	30930	191
30006	195	30140	201	30349	177	30479	180	30567	189	30825	189	30931	191
30007	196	30141	196	30350	181	30480	180	30568	191	30826	189	30932	191
30008	196	30142	201	30351	177	30481	180	30569	189	30827	189	30933	191
30009	196	30143	196	30352	181	30482	180	30570	191	30828	189	30934	191
30010	196	30145	196	30353	177	30483	180	30571	189	30829	189	30935	191
30011	196	30147	196	30354	181	30484	180	30572	191	30830	189	30936	191
30012	196	30149	196	30355	177	30485	180	30573	189	30831	189	30937	191
30013	196	30151	196	30356	181	30486	180	30574	191	30832	189	30938	191
30014	196	30153	196	30357	177	30487	180	30575	189	30833	189	30939	191
30015	196	30155	196	30358	181	30488	180	30576	191	30834	189	30940	191
30016	196	30157	196	30359	177	30489	180	30577	189	30835	189	30941	191
30017	196	30159	196	30360	181	30490	180	30578	191	30836	189	30942	191
30018	196	30161	197	30361	177	30491	180	30579	189	30837	189	30943	191
30019	196	30163	197	30362	181	30492	181	30589	210	30838	189	30944	191
30020	196	30165	197	30363	177	30493	181	30590	191	30839	189	30944	211
30021	197	30167	197	30364	181	30494	181	30590	211	30840	189	30944	211
30022	197	30169	197	30365	178	30495	181	30591	181	30841	189	30944	211
30023	197	30171	197	30366	181	30496	181	30592	181	30842	189	31132	191
30024	197	30173	197	30367	178	30497	181	30593	181	30843	189	31133	191
30025	197	30175	198	30368	181	30498	181	30594	181	30844	189	31134	191
30026	197	30177	195	30369	178	30499	181	30595	181	30845	189	31135	191
30027	197	30178	201	30370	181	30500	181	30596	181	30846	189	31136	191
30028	198	30179	196	30371	178	30501	189	30597	181	30847	189	31137	191
30029	195	30180	197	30372	181	30502	191	30598	181	30848	189	31138	191
30030	198	30181	197	30373	178	30503	189	30599	180	30849	189	31139	191
30030	210	30182	197	30374	181	30504	191	30600	181	30850	189	31140	191
30031	201	30183	198	30375	178	30505	189	30600	211	30850	210	31141	191
30032	201	30189	198	30376	181	30506	191	30602	191	30851	191	31142	191
30033	201	30189	210	30377	176	30507	189	30604	191	30852	191	31143	191
30034	201	30190	211	30378	180	30508	191	30606	191	30853	191	31144	191
30035	201	30191	195	30379	196	30509	189	30608	191	30854	191	31145	191
30036	201	30192	195	30380	197	30510	191	30610	191	30855	191	31146	191
30037	201	30193	195	30381	197	30511	189	30612	191	30856	191	31147	191
30038	201	30194	195	30382	197	30512	191	30771	189	30857	191	31148	191
30039	201	30195	195	30383	198	30513	189	30772	189	30858	191	31149	191
30040	201	30196	195	30389	178	30514	191	30773	189	30859	191	31150	191
30041	201	30197	195	30389	210	30515	189	30774	189	30860	191	31151	191
30042	201	30198	195	30390	181	30516	191	30775	189	30861	191	31152	191
30043	201	30199	195	30390	211	30517	189	30776	189	30862	191	31153	191
30044	201	30300	195	30397	176	30518	191	30777	189	30863	191	31154	191
30045	201	30301	176	30398	176	30519	189	30778	189	30864	191	31155	191
30046	201	30302	180	30399	176	30520	191	30779	189	30865	191	31156	191
30047	201	30303	176	30400	176	30521	189	30780	189	30866	191	31157	191
30048	201	30304	180	30435	176	30522	191	30781	189	30867	191	31158	191
30049	201	30305	176	30436	176	30523	189	30782	189	30868	191	31159	191
30050	201	30306	180	30437	176	30524	191	30783	189	30869	191	31160	191
30051	201	30307	176	30438	176	30525	189	30784	189	30870	191	31161	191
30059	201	30308	180	30439	176	30526	191	30785	189	30871	191	31162	191
30070	211	30309	176	30440	176	30527	189	30786	189	30872	191	31163	191
30101	195	30310	180	30441	176	30528	191	30787	189	30873	191	31164	191
30102	201	30311	176	30442	176	30529	189	30788	189	30874	191	31165	191
30103	195	30312	180	30443	176	30530	191	30789	189	30875	191	31166	191
30104	201	30313	176	30444	176	30531	189	30790	189	30876	191	31167	191
30105	195	30314	180	30445	176	30532	191	30791	189	30877	191	31168	191
30106	201	30315	176	30446	176	30533	189	30792	189	30878	191	31169	191
30107	195	30316	180	30447	176	30534	191	30793	189	30879	191	31169	211
30108	201	30317	176	30448	176	30535	189	30794	189	30880	191	31170	203
30109	195	30318	180	30449	177	30536	191	30795	189	30881	191	31171	203
30110	201	30319	176	30450	177	30537	189	30796	189	30882	191	31172	203
30111	195	30320	180	30451	177	30538	191	30797	189	30883	191	31173	203
30112	201	30321	176	30452	177	30539	189	30798	189	30884	191	31174	203
30113	195	30322	180	30453	177	30540	191	30799	189	30885	191	31175	203
30114	201	30323	176	30454	177	30541	189	30800	189	30886	191	31176	203
30115	195	30324	180	30455	177	30542	191	30801	189	30887	191	31177	203
30116	201	30325	176	30456	177	30543	189	30802	189	30888	191	31178	203
30117	195	30326	180	30457	177	30544	191	30803	189	30889	191	31179	203
30118	201	30327	176	30458	177	30545	189	30804	189	30890	191	31180	203
30119	195	30328	180	30459	177	30546	191	30805	189	30900	211	31181	203
30120	201	30329	176	30460	177	30547	189	30806	189	30902	191	31182	203
30121	195	30330	180	30461	177	30548	191	30807	189	30904	191	31183	203
30122	201	30331	176	30462	177	30549	189	30808	189	30906	191	31184	203
30123	195	30332	180	30463	178	30550	191	30809	189	30908	191	31185	203
30124	201	30333	176	30464	178	30551	189	30810	189	30910	191	31186	203
30125	195	30334	180	30465	178	30552	191	30810	210	30912	191	31187	203
30126	201	30335	176	30466	178	30553	189	30811	189	30914	191	31188	203
30127	195	30336	180	30467	178	30554	191	30812	189	30916	191	31189	203
30128	201	30337	177	30468	178	30555	189	30813	189	30918	191	31190	203
30129	195	30338	180	30469	176	30556	191	30814	189	30920	191	31190	210
30130	201	30339	177	30470	178	30557	189	30815	189	30921	191	31217	204
30131	195	30340	180	30471	210	30558	191	30816	189	30922	191	31217	211
30132	201	30341	177	30472	180	30559	189	30817	189	30923	191	31218	204
30133	196	30342	180	30472	180	30560	191	30818	189	30924	191	31219	204

EDP Number Index

EDP NO.	PAGE	EDP NO.	PAGE	EDP NO.	PAGE	EDP NO.	PAGE	EDP NO.	PAGE	EDP NO.	PAGE	EDP NO.	PAGE
31220	204	31346	184	31463	203	31563	183	31752	185	31871	195	31985	181
31221	204	31347	184	31464	204	31564	184	31753	185	31872	196	31986	181
31222	204	31348	184	31465	203	31565	183	31754	185	31873	196	31987	181
31223	204	31349	184	31466	204	31566	184	31755	185	31874	196	31988	180
31224	204	31350	184	31467	203	31567	183	31756	185	31875	196	31989	180
31225	204	31351	184	31468	204	31568	184	31757	185	31876	197	31990	180
31226	204	31352	184	31469	203	31569	183	31758	185	31877	197	31991	180
31227	204	31353	184	31470	204	31570	184	31759	185	31878	197	31992	181
31228	204	31354	184	31471	203	31571	183	31760	185	31879	198	31993	181
31229	204	31355	184	31472	204	31572	184	31761	185	31880	195	31994	181
31230	204	31356	184	31473	203	31573	183	31762	185	31881	195	31995	181
31231	204	31357	184	31474	204	31574	184	31763	196	31882	196	31996	181
31232	204	31357	211	31475	203	31575	183	31764	196	31883	196	31997	181
31233	204	31358	185	31476	204	31576	184	31765	196	31884	196	32033	163
31234	204	31359	185	31477	203	31577	183	31766	197	31885	196	32034	163
31235	204	31360	185	31478	204	31578	184	31767	197	31886	197	32035	163
31236	204	31361	185	31479	203	31579	183	31768	197	31887	197	32036	163
31237	204	31362	185	31480	204	31580	184	31769	198	31888	197	32037	163
31238	205	31363	185	31481	203	31581	183	31770	201	31889	198	32038	163
31239	205	31364	185	31481	210	31581	210	31771	201	31890	180	32039	163
31240	205	31365	185	31482	204	31582	184	31772	201	31891	180	32040	163
31241	205	31366	185	31482	211	31582	211	31773	201	31892	180	32041	163
31242	205	31367	185	31489	203	31589	183	31780	201	31893	180	32042	163
31243	205	31368	185	31489	210	31589	210	31781	201	31894	181	32043	163
31244	205	31369	185	31490	204	31590	184	31782	201	31895	181	32044	163
31245	205	31370	185	31490	211	31590	211	31783	201	31896	181	32045	163
31246	205	31401	203	31501	183	31601	205	31790	201	31897	181	32046	163
31247	205	31402	204	31502	184	31603	205	31791	201	31898	181	32047	163
31248	205	31403	203	31503	183	31605	205	31792	201	31899	181	32048	163
31249	205	31404	204	31504	184	31607	205	31793	201	31900	201	32049	163
31250	205	31405	203	31505	183	31609	205	31800	176	31902	201	32053	163
31251	205	31406	204	31506	184	31611	205	31802	176	31904	201	32054	163
31252	205	31407	203	31507	183	31613	205	31804	177	31906	201	32055	163
31253	205	31408	204	31508	184	31615	205	31806	177	31918	201	32056	163
31254	205	31409	203	31509	183	31617	205	31810	176	31919	201	32057	163
31255	205	31410	204	31510	184	31619	205	31812	176	31920	201	32058	163
31256	205	31411	203	31511	183	31621	205	31814	177	31921	201	32059	163
31257	205	31412	204	31512	184	31623	205	31816	177	31928	201	32060	163
31258	205	31413	203	31513	183	31625	205	31817	178	31929	201	32061	163
31259	205	31414	204	31514	184	31650	205	31819	178	31930	201	32062	163
31260	205	31415	203	31515	183	31651	205	31820	176	31931	201	32063	163
31261	205	31416	204	31516	184	31652	205	31821	177	31938	176	32064	163
31262	205	31417	203	31517	183	31653	205	31822	177	31939	176	32065	163
31263	205	31418	204	31518	184	31654	205	31823	178	31940	176	32066	163
31303	185	31419	203	31519	183	31655	205	31824	178	31941	177	32067	163
31304	185	31420	204	31520	184	31656	205	31825	176	31942	177	32068	163
31305	185	31421	203	31521	183	31657	205	31826	177	31943	177	32069	163
31306	185	31422	204	31522	184	31658	205	31827	177	31944	178	32200	188
31307	185	31423	203	31523	183	31659	205	31830	180	31945	178	32201	188
31308	185	31424	204	31524	184	31660	205	31831	180	31946	178	32202	188
31309	185	31425	203	31525	183	31661	205	31832	180	31947	178	32203	188
31310	185	31426	204	31526	184	31662	205	31833	180	31948	176	32204	188
31311	185	31427	203	31527	183	31701	185	31834	181	31949	176	32205	188
31312	185	31428	204	31528	184	31703	185	31835	181	31950	176	32206	188
31313	185	31429	203	31529	183	31705	185	31836	181	31951	177	32207	188
31314	185	31430	204	31530	184	31707	185	31837	181	31952	177	32210	188
31315	185	31431	203	31531	183	31709	185	31838	181	31953	177	32211	188
31316	183	31432	204	31532	184	31711	185	31839	181	31954	178	32212	188
31317	183	31433	203	31533	183	31713	185	31840	180	31955	178	32213	188
31318	183	31434	204	31534	184	31715	185	31841	180	31956	178	32214	188
31319	183	31435	203	31535	183	31717	185	31842	180	31957	178	32215	188
31320	183	31436	204	31536	184	31719	185	31843	180	31958	176	32216	188
31321	183	31437	203	31537	183	31721	185	31844	181	31959	176	32217	188
31322	183	31438	204	31538	184	31723	185	31845	181	31960	176	32260	187
31323	183	31439	203	31539	183	31725	185	31846	181	31961	177	32261	187
31324	183	31440	204	31540	184	31727	195	31847	181	31962	177	32262	187
31325	183	31441	203	31541	183	31728	195	31848	181	31963	177	32263	187
31326	183	31442	204	31542	184	31729	196	31849	181	31964	178	32264	187
31327	183	31443	203	31543	183	31730	196	31850	176	31965	178	32265	187
31328	183	31444	204	31544	184	31731	196	31851	176	31966	178	32266	187
31329	183	31445	203	31545	183	31732	196	31852	176	31967	178	32267	187
31330	183	31446	204	31546	184	31733	197	31853	177	31968	180	32270	187
31331	183	31447	203	31547	183	31735	197	31854	177	31969	180	32271	187
31332	183	31448	204	31548	184	31736	198	31855	177	31970	180	32272	187
31333	183	31449	203	31549	183	31737	195	31856	177	31971	180	32273	187
31334	183	31450	204	31550	184	31738	195	31857	178	31972	181	32274	187
31335	183	31451	203	31551	183	31739	196	31859	178	31973	181	32275	187
31336	183	31452	204	31552	184	31740	196	31860	195	31974	181	32276	187
31336	210	31453	203	31553	183	31741	196	31861	195	31975	181	32277	187
31337	184	31454	204	31554	184	31742	196	31862	196	31976	181	32280	187
31338	184	31455	203	31555	183	31743	197	31863	196	31977	181	32281	187
31339	184	31456	204	31556	184	31745	197	31864	196	31978	180	32282	187
31340	184	31457	203	31557	183	31746	198	31865	196	31979	180	32283	187
31341	184	31458	204	31558	184	31747	195	31866	197	31980	180	32284	187
31342	184	31459	203	31559	183	31748	195	31867	197	31981	180	32285	187
31343	184	31460	204	31560	184	31749	196	31868	197	31982	181	32286	187
31344	184	31461	203	31561	183	31750	185	31869	198	31983	181	32287	187
31345	184	31462	204	31562	184	31751	185	31870	195	31984	181	32290	188

EDP Number Index

EDP NO.	PAGE	EDP NO.	PAGE	EDP NO.	PAGE	EDP NO.	PAGE	EDP NO.	PAGE	EDP NO.	PAGE	EDP NO.	PAGE
32291	188	32403	194	32571	64	32692	140	32793	141	33117	198	33412	146
32292	188	32404	194	32572	64	32697	141	32794	141	33121	195	33413	146
32293	188	32405	194	32573	63	32698	141	32795	141	33122	201	33415	146
32294	188	32406	194	32574	63	32699	142	32796	142	33123	196	33416	146
32295	188	32407	194	32575	64	32700	140	32797	142	33124	201	33417	146
32296	188	32408	194	32576	64	32701	140	32798	142	33125	196	33418	146
32297	188	32409	194	32577	64	32702	140	32799	142	33126	201	33419	146
32301	193	32410	194	32578	64	32703	140	32800	142	33127	196	33420	146
32302	193	32411	194	32579	64	32704	140	32801	142	33129	196	33421	146
32303	193	32412	194	32580	64	32705	140	32802	142	33131	197	33422	146
32304	193	32413	194	32581	64	32706	140	32803	142	33133	197	33423	146
32305	193	32414	194	32582	64	32707	140	32804	142	33135	197	33424	146
32306	193	32415	194	32583	64	32708	140	32805	142	33137	198	33450	146
32307	193	32416	194	32584	64	32709	140	32806	142	33141	195	33451	146
32308	193	32417	194	32585	64	32710	141	32807	142	33142	201	33452	146
32309	193	32418	194	32586	64	32711	141	32808	142	33143	195	33453	146
32310	193	32419	194	32587	64	32712	141	32809	142	33144	201	33454	146
32311	193	32420	194	32588	64	32713	141	32810	142	33301	176	33455	146
32312	193	32421	194	32589	64	32714	141	32815	140	33302	180	33456	146
32313	193	32422	194	32590	64	32715	141	32816	140	33303	176	33457	146
32314	193	32423	194	32591	63	32716	141	32817	140	33304	180	33458	146
32315	193	32424	194	32592	63	32717	142	32818	140	33305	177	33460	146
32316	193	32425	194	32593	63	32718	142	32819	140	33306	180	33461	146
32317	193	32426	194	32594	64	32719	142	32820	140	33307	177	33462	146
32318	193	32427	194	32595	64	32720	142	32821	140	33308	181	33463	146
32319	193	32428	194	32596	64	32725	140	32822	140	33309	177	33464	146
32320	193	32429	194	32597	64	32726	140	32823	140	33310	181	33466	146
32321	193	32430	194	32598	64	32727	140	32824	140	33311	177	33467	146
32322	193	32431	194	32599	64	32728	140	32825	137	33312	181	33468	146
32323	193	32434	194	32600	64	32729	140	32826	140	33313	178	33469	146
32324	193	32435	194	32601	64	32730	140	32827	140	33314	181	33470	146
32325	193	32436	194	32602	64	32731	140	32828	140	33316	181	33471	146
32326	193	32437	194	32603	64	32732	140	32829	140	33317	178	33472	146
32327	193	32438	194	32604	64	32733	140	32830	137	33318	181	33473	146
32328	193	32439	194	32605	64	32734	140	32831	140	33321	176	33475	146
32329	193	32440	194	32606	63	32735	141	32832	140	33322	180	33476	146
32330	193	32441	194	32607	63	32736	141	32833	140	33323	176	33477	146
32333	193	32442	194	32608	63	32737	141	32834	140	33324	180	33478	146
32334	193	32443	194	32609	63	32738	141	32835	141	33325	177	33479	146
32335	193	32445	194	32610	63	32739	141	32836	141	33326	180	33480	146
32336	193	32446	194	32611	63	32740	141	32837	141	33327	177	33481	146
32337	193	32447	194	32612	63	32741	141	32838	141	33328	181	33482	146
32338	193	32448	194	32613	63	32742	142	32839	141	33329	177	33483	146
32339	193	32449	194	32614	63	32743	142	32840	141	33330	181	33484	146
32340	193	32450	194	32615	63	32744	142	32841	141	33331	178	33500	147
32341	193	32451	194	32616	63	32745	142	32842	141	33332	181	33501	147
32342	193	32452	194	32619	63	32751	140	32843	141	33333	178	33502	147
32345	193	32453	194	32620	63	32752	140	32844	141	33334	181	33503	147
32346	193	32454	194	32621	63	32753	140	32845	141	33335	178	33504	147
32347	193	32455	194	32625	63	32754	140	32846	141	33336	181	33507	147
32348	193	32456	194	32626	63	32755	140	32847	141	33337	178	33508	147
32349	193	32457	194	32627	63	32756	140	32848	141	33338	181	33511	147
32350	193	32458	194	32628	63	32757	140	32849	141	33341	176	33512	147
32351	193	32459	194	32632	64	32758	140	32850	141	33342	180	33513	147
32352	193	32460	194	32633	64	32759	140	32851	141	33343	176	33514	147
32353	193	32461	194	32635	63	32760	140	32852	141	33344	180	33515	147
32354	193	32462	194	32656	63	32761	137	32853	141	33345	97	33516	147
32355	193	32463	194	32657	63	32762	140	32854	141	33346	97	33517	147
32356	193	32464	194	32658	63	32763	140	32855	141	33347	97	33518	147
32357	193	32470	194	32659	63	32764	140	32856	141	33348	97	33519	147
32358	193	32471	194	32660	63	32765	140	32857	141	33349	97	33520	147
32359	193	32472	194	32661	63	32766	137	32858	141	33350	97	33521	147
32360	193	32473	194	32662	63	32767	140	32859	141	33351	97	33522	147
32361	193	32474	194	32663	64	32768	140	32860	142	33352	97	33523	147
32362	193	32475	194	32664	64	32769	140	32861	142	33353	97	33524	147
32363	193	32476	194	32665	64	32770	140	32862	142	33354	97	33525	147
32364	193	32477	194	32666	64	32771	141	32863	142	33360	117	33540	147
32370	193	32478	194	32667	64	32772	141	32864	142	33361	117	33541	147
32371	193	32479	194	32668	64	32773	141	32865	142	33390	146	33542	147
32372	193	32480	194	32669	64	32774	141	32866	142	33391	146	33543	147
32373	193	32481	194	32670	64	32775	141	32867	142	33392	146	33544	147
32374	193	32482	194	32671	64	32776	141	32868	142	33393	146	33547	147
32375	193	32483	194	32672	63	32777	141	32869	142	33394	146	33548	147
32376	193	32484	194	32673	63	32778	141	32870	142	33395	146	33551	147
32377	193	32485	194	32674	63	32779	141	32871	142	33396	146	33552	147
32378	193	32486	194	32675	63	32780	141	32872	142	33397	146	33553	147
32379	193	32487	194	32676	63	32781	141	32873	142	33398	146	33554	147
32380	193	32488	194	32677	63	32782	141	32874	142	33400	146	33555	147
32381	193	32489	194	32678	64	32783	141	33101	195	33401	146	33556	147
32382	193	32500	68	32679	64	32784	141	33102	201	33402	146	33557	147
32383	193	32501	68	32680	64	32785	141	33103	196	33403	146	33558	147
32384	193	32502	68	32681	64	32786	141	33104	201	33404	146	33559	147
32385	193	32503	68	32685	64	32787	141	33105	196	33406	146	33560	147
32386	193	32504	68	32686	64	32788	141	33106	201	33407	146	33561	147
32387	193	32505	68	32687	64	32789	141	33107	196	33408	146	33562	147
32388	193	32506	68	32688	64	32790	141	33109	196	33409	146	33563	147
32389	193	32569	63	32689	64	32791	141	33111	197	33410	146	33564	147
32402	194	32570	64	32691	140	32792	141	33115	197	33411	146	33565	147

EDP Number Index

EDP NO.	PAGE	EDP NO.	PAGE	EDP NO.	PAGE	EDP NO.	PAGE	EDP NO.	PAGE	EDP NO.	PAGE	EDP NO.	PAGE
35704	138	36126	207	36385	40	36570	57	36786	61	37020	29	37108	31
35705	138	36128	207	36386	40	36571	57	36787	61	37021	29	37109	31
35706	138	36129	207	36387	40	36572	57	36788	61	37022	29	37110	31
35707	138	36130	207	36388	40	36573	57	36789	61	37023	29	37111	31
35708	138	36140	110	36389	40	36574	57	36790	61	37024	30	37112	31
35709	138	36141	110	36390	40	36575	57	36791	61	37025	30	37113	31
35710	138	36142	110	36391	40	36576	57	36792	61	37026	30	37114	31
35711	138	36143	110	36392	40	36577	57	36793	61	37027	30	37115	31
35712	138	36206	208	36393	40	36578	57	36804	39	37028	30	37116	32
35713	138	36207	208	36404	49	36590	50	36805	39	37029	30	37117	32
35714	138	36208	208	36406	49	36591	50	36806	40	37030	30	37118	32
35715	138	36209	208	36408	49	36592	50	36807	40	37031	30	37119	32
35716	138	36210	208	36416	49	36596	49	36808	40	37032	30	37120	32
35717	138	36211	208	36418	49	36597	49	36809	40	37033	30	37121	32
35718	138	36212	208	36420	49	36598	49	36810	39	37034	30	37122	32
35719	138	36213	208	36422	49	36599	39	36811	39	37035	30	37123	32
35720	138	36214	208	36424	49	36600	39	36812	39	37036	30	37124	32
35721	138	36216	208	36426	49	36601	39	36813	40	37037	30	37125	32
35722	138	36217	208	36428	49	36602	40	36814	40	37038	30	37126	32
35723	139	36218	208	36430	49	36603	40	36815	40	37039	30	37127	32
35724	139	36220	208	36432	49	36604	40	36816	40	37040	30	37128	32
35725	139	36221	208	36436	49	36605	40	36817	40	37041	30	37129	32
35726	139	36222	208	36440	49	36610	40	36818	40	37042	30	37130	32
35727	139	36224	208	36442	49	36611	40	36819	40	37043	30	37131	32
35728	139	36225	208	36444	49	36612	40	36820	40	37044	30	37132	32
35729	139	36226	208	36447	41	36613	40	36821	40	37045	30	37133	32
35730	139	36228	208	36448	41	36614	40	36822	40	37046	30	37134	32
35731	139	36229	208	36449	41	36615	40	36823	40	37047	30	37135	32
35732	139	36230	208	36450	41	36616	57	36824	40	37048	30	37136	32
35733	139	36235	140	36452	41	36617	57	36825	40	37049	30	37137	32
35734	139	36236	140	36453	41	36618	57	36826	49	37050	30	37138	32
35735	139	36237	143	36454	41	36620	90	36827	49	37051	30	37139	32
35736	139	36238	143	36456	41	36621	90	36828	49	37052	30	37140	32
35737	139	36239	140	36457	41	36622	90	36829	49	37053	30	37141	32
35738	139	36240	140	36458	41	36623	90	36830	49	37054	30	37142	32
35739	139	36241	143	36460	41	36624	90	36846	50	37055	30	37143	32
35740	139	36242	143	36462	41	36625	90	36847	50	37056	30	37144	32
35741	139	36243	140	36463	41	36626	90	36848	50	37057	30	37145	32
35742	139	36244	140	36464	41	36627	90	36849	50	37058	30	37146	32
35743	139	36245	143	36466	41	36628	90	36850	50	37059	30	37147	32
35744	139	36246	143	36468	41	36629	90	36851	39	37060	30	37148	32
35787	140	36247	143	36469	41	36630	90	36852	39	37061	30	37149	32
35788	140	36248	143	36470	41	36631	90	36853	39	37062	30	37150	32
35789	143	36249	143	36472	41	36632	90	36854	39	37063	30	37151	32
35790	143	36250	143	36474	41	36633	90	36855	39	37064	30	37152	32
35791	140	36251	141	36475	41	36634	90	36856	39	37065	30	37153	32
35792	140	36252	141	36480	42	36635	90	36857	39	37066	30	37154	32
35793	143	36253	143	36482	42	36636	90	36858	39	37067	30	37155	32
35794	143	36254	143	36486	42	36637	90	36859	40	37068	30	37156	32
35795	140	36257	142	36500	42	36638	90	36860	40	37069	30	37157	32
35796	140	36258	142	36502	42	36639	90	36861	40	37070	30	37160	29
35797	143	36259	142	36504	42	36640	90	36862	40	37071	30	37161	29
35798	143	36260	142	36505	49	36641	90	36863	40	37072	30	37162	29
35799	143	36261	143	36506	49	36701	39	36864	39	37073	30	37163	29
35800	143	36262	143	36507	49	36702	39	36865	39	37074	30	37164	29
35801	143	36263	143	36508	49	36704	39	36866	39	37075	31	37165	29
35802	143	36264	143	36509	49	36706	39	36867	40	37076	31	37166	29
35803	141	36265	143	36511	49	36707	39	36868	40	37077	31	37167	29
35804	141	36266	143	36513	49	36709	40	36869	40	37078	31	37174	29
35805	143	36344	50	36515	49	36710	40	36870	40	37079	31	37180	28
35806	143	36345	50	36517	49	36711	40	36871	40	37080	31	37181	28
35809	142	36346	50	36519	49	36712	40	36872	39	37081	30	37182	28
35810	142	36347	50	36520	49	36713	40	36873	39	37082	31	37183	28
35811	142	36348	50	36530	49	36714	40	36874	39	37083	31	37184	28
35812	142	36349	50	36531	49	36715	40	36875	39	37084	31	37185	28
35813	143	36350	50	36532	49	36716	40	36876	39	37085	31	37186	28
35814	143	36351	50	36533	49	36717	40	36877	39	37086	31	37187	29
35815	143	36352	50	36534	49	36718	40	36878	39	37087	31	37188	29
35816	143	36353	50	36535	49	36719	40	37000	28	37088	31	37189	29
35817	143	36354	50	36536	49	36722	39	37001	28	37089	31	37190	30
35818	143	36355	50	36537	49	36723	39	37002	28	37090	31	37191	30
36106	207	36356	50	36538	49	36724	39	37003	28	37091	31	37192	30
36107	207	36357	50	36539	50	36725	39	37004	28	37092	31	37193	30
36108	207	36358	50	36540	50	36727	39	37005	28	37093	31	37194	30
36109	207	36359	50	36541	50	36729	39	37006	28	37094	31	37195	30
36110	207	36361	50	36542	50	36731	40	37007	28	37095	31	37196	30
36111	207	36370	39	36543	50	36733	40	37008	28	37096	31	37197	30
36112	207	36371	39	36544	50	36736	39	37009	28	37097	31	37198	30
36113	207	36372	39	36545	50	36738	39	37010	28	37098	31	37199	31
36114	207	36373	39	36546	50	36740	39	37011	28	37099	31	37200	31
36116	207	36374	39	36547	50	36742	40	37012	28	37100	31	37201	31
36117	207	36375	39	36555	57	36744	40	37013	28	37101	31	37202	30
36118	207	36376	39	36556	57	36780	61	37014	29	37102	31	37203	31
36120	207	36378	39	36557	57	36781	61	37015	29	37103	31	37204	31
36121	207	36380	39	36558	57	36782	61	37016	29	37104	31	37205	31
36122	207	36381	39	36559	57	36783	61	37017	29	37105	31	37206	31
36124	207	36383	40	36560	57	36784	61	37018	29	37106	31	37207	31
36125	207	36384	40	36561	57	36785	61	37019	29	37107	31	37208	31

EDP Number Index

EDP NO.	PAGE	EDP NO.	PAGE	EDP NO.	PAGE	EDP NO.	PAGE	EDP NO.	PAGE	EDP NO.	PAGE	EDP NO.	PAGE
38661	32	38854	31	39071	197	39317	176	39523	176	39629	203	39757	189
38662	32	38855	31	39073	197	39318	180	39524	180	39630	204	39759	189
38663	32	38856	31	39075	198	39319	176	39525	176	39631	203	39761	189
38664	32	38857	31	39077	195	39320	180	39526	180	39632	204	39763	189
38770	28	38858	31	39078	201	39321	176	39527	176	39633	203	39765	189
38771	28	38859	31	39089	198	39322	180	39528	180	39634	204	39767	189
38772	28	38860	31	39089	210	39323	176	39529	176	39635	203	39769	189
38773	28	38861	31	39090	211	39324	180	39530	180	39636	204	39771	189
38774	28	38862	31	39101	195	39325	176	39531	176	39637	203	39773	189
38775	28	38863	31	39102	201	39326	180	39532	180	39638	204	39775	189
38776	28	38864	31	39103	195	39327	176	39533	176	39639	203	39777	189
38777	28	38865	31	39104	201	39328	180	39534	180	39640	204	39789	189
38778	28	38866	31	39105	195	39329	176	39535	176	39641	203	39789	210
38779	28	38867	31	39106	201	39330	180	39536	180	39641	210	40000	199
38780	28	38868	32	39107	195	39331	176	39537	177	39642	204	40001	199
38781	28	38869	32	39108	201	39332	180	39538	180	39642	211	40003	199
38782	28	38870	32	39109	195	39333	176	39539	177	39651	183	40004	199
38783	28	38871	32	39110	201	39334	180	39540	180	39652	184	40005	199
38784	28	38872	32	39111	195	39335	176	39541	177	39653	183	40007	199
38785	28	38873	32	39112	201	39336	180	39542	180	39654	184	40009	199
38786	28	38874	32	39113	195	39337	177	39543	177	39655	183	40010	199
38787	28	38875	32	39114	201	39338	180	39544	181	39656	184	40011	199
38788	28	38876	32	39115	195	39339	177	39545	177	39657	183	40012	199
38789	28	38877	32	39116	201	39340	180	39546	181	39658	184	40015	199
38790	28	38878	32	39117	195	39341	177	39547	177	39659	183	40016	199
38791	28	38879	32	39118	201	39342	180	39548	181	39660	184	40017	199
38792	28	38880	32	39119	195	39343	177	39549	177	39661	183	40019	199
38793	28	38881	32	39120	201	39344	181	39550	181	39662	184	40020	199
38794	28	38882	32	39121	195	39345	177	39551	177	39663	183	40021	200
38795	28	38883	32	39122	201	39346	181	39552	181	39664	184	40023	200
38796	28	38884	32	39123	195	39347	177	39553	177	39665	183	40024	200
38797	28	38885	32	39124	201	39348	181	39554	181	39666	184	40025	200
38798	29	39001	195	39125	195	39349	177	39555	177	39667	183	40028	200
38799	29	39002	201	39126	201	39350	181	39556	181	39668	184	40030	200
38800	29	39003	195	39127	195	39351	177	39557	177	39669	183	40031	200
38801	29	39004	201	39128	201	39352	181	39558	181	39670	184	40032	200
38802	29	39005	195	39129	195	39353	177	39559	177	39671	183	40035	200
38803	29	39006	201	39130	201	39354	181	39560	181	39672	184	40037	200
38804	29	39007	195	39131	195	39355	177	39561	177	39673	183	40038	200
38805	29	39008	201	39132	201	39356	181	39562	181	39674	184	40039	200
38806	29	39009	195	39133	196	39357	177	39563	177	39675	183	40105	199
38807	29	39010	201	39134	201	39358	181	39564	181	39676	184	40106	202
38808	29	39011	195	39135	196	39359	177	39565	178	39677	183	40109	199
38809	29	39012	201	39136	201	39360	181	39566	181	39678	184	40110	202
38810	29	39013	195	39137	196	39361	177	39567	178	39679	183	40113	199
38811	29	39014	201	39138	201	39362	181	39568	181	39680	184	40114	202
38812	29	39015	195	39139	196	39363	177	39569	178	39681	183	40117	199
38813	29	39016	201	39140	201	39364	181	39570	181	39682	184	40118	202
38814	29	39017	195	39141	196	39365	178	39571	178	39683	183	40121	199
38815	29	39018	201	39142	201	39366	181	39572	181	39684	184	40122	202
38816	29	39019	195	39143	196	39367	178	39573	178	39685	183	40125	199
38817	29	39020	201	39145	196	39368	181	39574	181	39686	184	40126	202
38818	29	39021	195	39147	196	39369	178	39575	178	39687	183	40129	199
38819	29	39022	201	39149	196	39370	181	39576	181	39688	184	40130	202
38820	29	39023	195	39151	196	39371	178	39577	176	39689	183	40133	199
38821	29	39024	201	39153	196	39372	181	39578	180	39690	184	40134	202
38822	29	39025	195	39155	196	39373	178	39589	178	39691	183	40137	199
38823	29	39026	201	39157	196	39374	181	39589	210	39691	210	40138	202
38824	29	39027	195	39159	196	39375	178	39590	181	39692	184	40141	199
38825	29	39028	201	39161	197	39376	181	39590	211	39692	211	40142	202
38826	30	39029	195	39163	197	39377	176	39601	203	39701	189	40145	199
38827	30	39030	201	39165	197	39378	180	39602	204	39703	189	40146	202
38828	30	39031	195	39167	197	39389	178	39603	203	39705	189	40149	199
38829	30	39032	201	39169	197	39389	210	39604	204	39707	189	40150	202
38830	30	39033	196	39171	197	39390	181	39605	203	39709	189	40153	199
38831	30	39034	201	39173	197	39390	211	39606	204	39711	189	40154	202
38832	30	39035	196	39175	198	39501	176	39607	203	39713	189	40157	199
38833	30	39036	201	39177	195	39502	180	39608	204	39715	189	40158	202
38834	30	39037	196	39178	201	39503	176	39609	203	39717	189	40161	200
38835	30	39038	201	39189	198	39504	180	39610	204	39719	189	40162	202
38836	30	39039	196	39189	210	39505	176	39611	203	39721	189	40165	205
38837	30	39040	201	39190	211	39506	180	39612	204	39723	189	40166	202
38838	30	39041	196	39301	176	39507	176	39613	203	39725	189	40169	200
38839	30	39042	201	39302	180	39508	180	39614	204	39727	189	40170	202
38840	30	39043	196	39303	176	39509	176	39615	203	39729	189	40173	200
38841	30	39045	196	39304	180	39510	180	39616	204	39731	189	40174	202
38842	30	39047	196	39305	176	39511	176	39617	203	39733	189	40177	200
38843	30	39049	196	39306	180	39512	180	39618	204	39735	189	40178	202
38844	30	39051	196	39307	176	39513	176	39619	203	39737	189	40181	200
38845	30	39053	196	39308	180	39514	180	39620	204	39739	189	40182	202
38846	30	39055	196	39309	176	39515	176	39621	203	39741	189	40185	200
38847	30	39057	196	39310	180	39516	180	39622	204	39743	189	40186	202
38848	30	39059	196	39311	176	39517	176	39623	203	39745	189	40305	179
38849	30	39061	197	39312	180	39518	180	39624	204	39747	189	40306	182
38850	31	39063	197	39313	176	39519	176	39625	203	39749	189	40309	179
38851	31	39065	197	39314	180	39520	180	39626	204	39751	189	40310	182
38852	31	39067	197	39315	176	39521	176	39627	203	39753	189	40313	179
38853	31	39069	197	39316	180	39522	180	39628	204	39755	189	40314	182

EDP Number Index

EDP NO.	PAGE	EDP NO.	PAGE	EDP NO.	PAGE	EDP NO.	PAGE	EDP NO.	PAGE	EDP NO.	PAGE	EDP NO.	PAGE
40317	179	41425	203	42608	65	42711	153	43470	100	43934	187	44591	160
40318	182	41426	204	42609	65	42712	59	43471	100	43935	187	44592	160
40321	179	41429	203	42610	65	42713	59	43472	100	43936	187	44593	160
40322	182	41430	204	42611	65	42714	59	43473	100	43937	187	44594	160
40325	179	41433	203	42612	65	42715	59	43474	100	43938	187	44595	160
40326	182	41434	204	42613	65	42716	59	43475	100	43939	187	44596	160
40329	179	41437	203	42614	65	42717	59	43476	100	43950	187	44597	160
40330	182	41438	204	42615	65	42718	45	43477	100	43951	187	44598	161
40333	179	41441	203	42616	65	42719	45	43478	100	43952	187	44599	161
40334	182	41442	204	42617	66	42721	45	43479	100	43953	187	44600	161
40337	179	41445	203	42618	66	42722	45	43480	100	43954	187	44601	161
40338	182	41446	204	42619	66	42723	45	43481	100	43955	187	44602	161
40341	179	41449	203	42620	66	42731	46	43482	100	43956	187	44603	161
40342	182	41450	204	42621	67	42732	46	43483	100	43957	187	44604	161
40345	179	41453	203	42622	65	42733	46	43484	100	43958	187	44605	161
40346	182	41454	204	42623	65	42734	46	43485	100	43959	187	44606	161
40349	179	41457	203	42624	66	42735	46	43486	100	44298	155	44607	161
40350	182	41458	204	42625	66	42736	46	43487	100	44299	155	44608	161
40353	179	41461	203	42626	66	42737	46	43488	100	44300	155	44609	160
40354	182	41462	204	42627	67	42738	46	43489	100	44301	155	44610	160
40357	179	41465	203	42628	66	42739	46	43490	100	44302	155	44611	160
40358	182	41466	204	42630	66	42750	68	43491	100	44303	155	44612	160
40361	179	41505	183	42631	66	42751	68	43492	100	44304	155	44613	160
40362	182	41506	184	42632	66	42752	68	43493	100	44305	155	44614	160
40365	179	41509	183	42633	66	42753	68	43494	100	44306	155	44615	161
40366	182	41510	184	42648	67	42754	68	43495	100	44307	155	44616	161
40369	179	41513	183	42649	67	42755	68	43496	100	44308	155	44617	161
40370	182	41514	184	42650	67	43101	199	43497	100	44309	155	44618	161
40373	179	41517	183	42651	67	43102	202	43501	190	44505	163	44619	161
40374	182	41518	184	42652	67	43103	199	43502	192	44506	163	44620	161
40377	179	41521	183	42653	67	43104	202	43503	190	44509	163	44627	134
40378	182	41522	184	42654	67	43105	199	43504	192	44510	163	44628	134
40381	179	41525	183	42655	67	43106	202	43505	190	44513	163	44629	134
40382	182	41526	184	42656	66	43107	199	43506	192	44514	163	44630	134
40385	179	41529	183	42657	66	43108	202	43507	190	44517	163	44631	134
40386	182	41530	184	42658	66	43115	199	43508	192	44518	163	44634	134
40505	190	41533	183	42659	66	43116	202	43515	190	44521	163	44635	134
40506	192	41534	184	42660	65	43125	200	43516	192	44522	163	44636	134
40509	190	41537	183	42661	65	43126	202	43525	190	44525	163	44637	134
40510	192	41538	184	42662	65	43135	200	43526	192	44526	163	44638	134
40513	190	41541	183	42663	65	43136	202	43535	190	44529	163	44639	134
40514	192	41542	184	42664	65	43145	200	43536	192	44530	163	44641	134
40517	190	41545	183	42665	65	43146	202	43545	190	44533	163	44642	134
40518	192	41546	184	42666	65	43155	200	43546	192	44534	163	44643	134
40521	190	41549	183	42667	65	43156	202	43555	190	44537	163	44701	149
40522	192	41550	184	42668	65	43165	200	43556	192	44538	163	44702	149
40525	190	41553	183	42669	65	43166	202	43565	190	44541	163	44703	149
40526	192	41554	184	42670	65	43175	200	43566	192	44542	163	44705	149
40529	190	41557	183	42671	65	43176	202	43575	190	44545	163	44708	150
40530	192	41558	184	42672	65	43185	200	43576	192	44546	163	44711	150
40533	190	41561	183	42673	65	43186	202	43585	190	44550	160	44714	151
40534	192	41562	184	42674	65	43195	200	43586	192	44551	160	44715	149
40537	190	41565	183	42675	65	43196	202	43595	190	44552	160	44716	149
40538	192	41566	184	42676	65	43301	179	43596	192	44553	160	44717	149
40541	190	41605	205	42677	65	43302	182	43900	188	44554	160	44719	149
40542	192	41609	205	42678	65	43303	179	43901	188	44555	160	44722	150
40545	190	41613	205	42679	65	43304	182	43902	188	44556	160	44725	150
40546	192	41617	205	42680	65	43305	179	43903	188	44557	160	44728	151
40549	190	41621	205	42681	66	43306	182	43904	188	44558	160	44731	151
40550	192	41625	205	42682	66	43307	179	43905	188	44559	160	44732	149
40553	190	41629	205	42683	66	43308	182	43906	188	44560	160	44733	150
40554	192	41633	205	42684	66	43315	179	43907	188	44561	160	44734	150
40557	190	41637	205	42685	66	43316	182	43908	188	44562	160	44735	150
40558	192	41641	205	42686	66	43325	179	43909	188	44563	160	44736	150
40561	190	41645	205	42687	66	43326	182	43910	187	44564	160	44737	151
40562	192	41649	205	42688	66	43335	179	43911	187	44565	160	44738	152
40565	190	41653	205	42689	66	43336	182	43912	187	44566	160	44739	153
40566	192	41657	205	42690	66	43345	179	43913	187	44570	161	44740	153
40569	190	41661	205	42691	66	43346	182	43914	187	44571	161	44741	153
40570	192	41665	200	42692	66	43355	179	43915	187	44572	161	44745	134
40573	190	41705	185	42693	66	43356	182	43916	187	44573	161	44746	134
40574	192	41709	185	42694	66	43365	179	43917	187	44574	161	44747	134
40577	190	41713	185	42695	66	43366	182	43918	187	44575	161	44748	134
40578	192	41717	185	42696	66	43375	179	43919	187	44576	161	44749	134
40581	190	41721	185	42697	66	43376	182	43920	187	44577	161	44750	134
40582	192	41725	185	42698	66	43385	179	43921	187	44578	161	44751	134
40585	190	41729	185	42699	66	43386	182	43922	187	44579	161	44752	134
40586	192	41733	185	42700	66	43395	179	43923	187	44580	161	44753	134
41405	203	41737	185	42701	67	43396	182	43924	187	44581	161	44754	134
41406	204	41741	185	42702	67	43445	100	43925	187	44582	161	44755	134
41409	203	41745	185	42703	67	43446	100	43926	187	44583	161	44756	134
41410	204	41749	185	42704	67	43447	100	43927	187	44584	161	44757	134
41413	203	41753	185	42705	67	43448	100	43928	187	44585	161	44758	134
41414	204	41757	185	42706	152	43449	100	43929	187	44586	161	44759	134
41417	203	41761	185	42707	152	43450	100	43930	187	44587	160	44760	134
41418	204	41765	185	42708	152	43451	100	43931	187	44588	160	44761	134
41421	203	42606	65	42709	152	43452	100	43932	187	44589	160	44762	134
41422	204	42607	65	42710	153	43453	100	43933	187	44590	160	44763	134

EDP Number Index

EDP NO.	PAGE	EDP NO.	PAGE	EDP NO.	PAGE	EDP NO.	PAGE	EDP NO.	PAGE	EDP NO.	PAGE	EDP NO.	PAGE
44764	134	44857	149	44965	153	45129	79	46110	207	46470	59	46830	46
44765	134	44858	149	44966	153	45130	79	46111	207	46471	59	46831	46
44766	134	44859	150	44967	153	45131	79	46112	207	46472	59	46832	46
44767	134	44860	150	44968	153	45132	79	46113	207	46473	59	46833	46
44768	134	44861	150	44969	153	45133	79	46114	207	46474	59	46834	46
44769	152	44862	150	44970	153	45134	79	46116	207	46475	59	46835	46
44770	152	44863	150	44971	153	45135	79	46117	207	46476	59	46836	46
44771	152	44864	150	44972	153	45136	79	46118	207	46477	59	46837	46
44772	152	44865	150	44973	153	45137	79	46120	207	46478	59	46838	46
44773	152	44866	150	44974	153	45138	79	46121	207	46479	59	46839	46
44774	152	44867	150	44975	129	45139	79	46122	207	46480	59	46840	46
44775	152	44868	150	44976	129	45140	79	46128	207	46481	59	46841	46
44776	152	44869	150	44977	129	45141	79	46129	207	46482	59	46849	45
44777	152	44870	150	44978	129	45150	78	46130	207	46483	59	46850	45
44778	152	44871	150	44979	129	45170	78	46131	207	46493	45	46851	45
44779	152	44872	150	44980	129	45171	78	46132	207	46494	45	46852	45
44780	152	44873	150	44981	129	45172	78	46133	207	46495	45	46853	45
44781	152	44874	150	44982	129	45173	78	46140	110	46497	45	46854	45
44782	152	44875	150	44983	129	45174	78	46141	110	46498	45	46855	45
44783	152	44876	150	44984	129	45175	78	46142	110	46506	53	46856	45
44784	152	44877	151	44985	129	45176	78	46143	110	46507	53	46857	45
44785	153	44878	151	44986	129	45177	78	46145	110	46508	53	46858	45
44786	153	44879	151	44987	129	45178	78	46147	110	46509	53	46859	45
44787	153	44880	151	44990	129	45179	78	46206	209	46510	53	46860	45
44788	153	44881	151	44991	129	45180	78	46207	209	46518	54	46861	45
44789	152	44882	151	44992	129	45181	78	46208	209	46519	54	46862	45
44790	152	44883	151	44993	129	45182	78	46209	209	46520	54	46863	45
44791	152	44884	151	44994	129	45183	78	46210	209	46521	54	46864	45
44792	152	44885	151	44995	129	45184	78	46211	209	46522	54	46865	45
44792	152	44886	151	44996	129	45185	78	46212	209	46560	61	46866	45
44793	152	44890	149	44997	129	45186	78	46213	209	46561	61	46867	45
44794	152	44891	149	44998	129	45187	79	46214	209	46562	61	46868	45
44795	152	44892	149	44999	129	45188	79	46216	209	46563	61	46869	45
44796	152	44893	149	45000	129	45189	79	46217	209	46564	61	46873	45
44797	152	44894	149	45001	129	45190	79	46218	209	46565	61	46874	45
44798	152	44895	149	45002	129	45191	79	46220	209	46566	61	46880	45
44799	152	44896	149	45003	129	45192	79	46221	209	46567	61	46881	45
44800	152	44897	150	45004	129	45193	79	46222	209	46568	61	46882	45
44801	152	44898	150	45005	130	45194	79	46228	209	46620	93	46884	45
44802	152	44899	150	45006	130	45195	79	46229	209	46621	93	46886	45
44803	152	44900	150	45007	130	45196	79	46230	209	46622	93	46887	45
44804	152	44901	151	45008	130	45197	79	46231	209	46623	93	46889	45
44805	153	44902	149	45009	130	45198	79	46232	209	46624	93	46890	45
44806	153	44916	154	45010	130	45199	79	46233	209	46625	93	46891	45
44807	153	44917	154	45011	130	45200	79	46343	54	46626	94	46893	45
44808	153	44918	154	45012	130	45201	79	46344	54	46627	93	46894	45
44814	150	44919	154	45013	130	45202	79	46345	54	46628	93	46895	45
44815	150	44920	154	45014	130	45203	79	46346	54	46629	93	46896	45
44816	150	44921	154	45015	130	45277	186	46347	54	46630	93	46898	45
44817	150	44922	154	45016	130	45279	186	46348	54	46631	93	46899	45
44818	150	44923	154	45017	130	45281	186	46349	54	46632	93	46900	45
44819	150	44924	154	45018	130	45283	186	46350	54	46633	93	46903	45
44820	150	44925	154	45019	130	45285	186	46351	54	46634	93	46904	45
44821	150	44926	154	45020	129	45287	186	46354	54	46635	93	46905	45
44822	151	44927	154	45021	129	45289	186	46355	54	46636	93	46909	45
44823	151	44928	154	45022	129	45291	186	46356	54	46637	93	46910	45
44824	151	44929	154	45023	129	45293	186	46357	53	46638	93	46911	45
44826	150	44930	154	45024	129	45295	186	46358	53	46639	93	46912	45
44827	150	44931	154	45025	129	45297	186	46359	53	46640	93	46913	45
44828	150	44932	154	45100	78	45299	186	46360	53	46641	93	46914	45
44829	150	44933	154	45101	78	45477	206	46362	53	46642	93	46915	45
44830	151	44934	154	45102	78	45478	206	46364	53	46643	93	46916	45
44831	151	44935	154	45103	78	45479	206	46366	53	46644	93	46917	45
44832	152	44936	154	45104	78	45480	206	46368	53	46645	93	46918	45
44833	152	44937	154	45105	78	45481	206	46370	53	46646	93	46919	45
44834	153	44938	154	45106	79	45482	206	46372	53	46647	93	46920	45
44835	153	44939	154	45107	79	45483	206	46374	53	46648	93	46921	45
44836	153	44940	154	45108	79	45484	206	46376	53	46649	93	46922	45
44837	153	44941	154	45109	79	45485	206	46450	59	46650	93	46923	45
44838	153	44942	154	45110	79	45486	206	46451	59	46651	93	46924	45
44839	152	44943	154	45111	79	45487	206	46452	59	46652	93	46925	45
44840	153	44944	154	45112	78	45488	206	46453	59	46653	94	46926	45
44841	153	44945	154	45113	78	45489	206	46454	59	46654	94	46927	45
44842	149	44950	152	45114	78	45490	206	46455	59	46655	94	46928	46
44843	149	44951	152	45115	78	45491	206	46456	59	46656	94	46929	46
44844	149	44952	152	45116	78	45492	206	46457	59	46657	94	46930	46
44845	149	44953	152	45117	78	45493	206	46458	59	46658	94	46931	46
44846	149	44954	152	45118	78	45494	206	46459	59	46659	94	46932	46
44847	149	44955	152	45119	78	45495	206	46460	59	46660	94	46933	46
44848	149	44956	152	45120	78	45496	206	46461	59	46821	46	46934	46
44849	149	44957	152	45121	78	45497	206	46462	59	46822	46	46935	46
44850	149	44958	152	45122	78	45498	206	46463	59	46823	46	46936	46
44851	149	44959	152	45123	78	45499	206	46464	59	46824	46	46937	46
44852	149	44960	152	45124	78	45500	206	46465	59	46825	46	46938	46
44853	149	44961	153	45125	78	46106	207	46466	59	46826	46	46939	46
44854	149	44962	153	45126	78	46107	207	46467	59	46827	46	46940	46
44855	149	44963	153	45127	79	46108	207	46468	59	46828	46	46941	46
44856	149	44964	153	45128	79	46109	207	46469	59	46829	46	46942	46

EDP Number Index

EDP NO.	PAGE	EDP NO.	PAGE	EDP NO.	PAGE	EDP NO.	PAGE	EDP NO.	PAGE	EDP NO.	PAGE	EDP NO.	PAGE
68303	289	68657	293	68983	305	70018	326	72954	342	74140	319	74366	84
68304	289	68658	293	68984	305	70019	326	72955	342	74143	319	74367	84
68305	289	68659	293	68985	305	70020	326	72956	342	74146	319	74368	84
68306	289	68660	293	68986	305	70021	326	72957	342	74149	322	74369	84
68307	289	68661	293	68987	305	70022	326	72958	342	74152	322	74370	84
68308	289	68662	293	68988	305	70023	326	72959	342	74155	322	74371	84
68309	289	68663	293	68989	305	70024	326	72960	342	74158	322	74372	84
68310	289	68664	293	68990	305	70025	326	72961	342	74161	322	74373	84
68311	289	68665	293	68991	305	70026	326	72962	342	74164	322	74374	84
68312	289	68666	293	68992	305	70027	326	72963	342	74167	322	74375	84
68313	289	68667	293	68993	305	70028	326	72964	342	74170	322	74376	84
68314	289	68668	293	68994	305	70029	326	72965	342	74201	316	74377	84
68315	289	68669	293	68995	305	70030	326	72966	342	74204	316	74378	84
68316	289	68670	293	68996	305	70031	326	72967	342	74207	316	74379	84
68317	290	68671	293	68997	305	70032	326	72968	342	74210	316	74380	84
68318	290	68672	293	68998	305	70041	104	72969	342	74213	316	74381	84
68319	290	68673	293	68999	305	70042	104	72970	345	74216	316	74382	84
68320	290	68674	293	69000	305	70044	104	72971	345	74219	316	74383	84
68321	290	68675	293	69001	305	70045	104	72972	345	74222	316	74384	84
68322	290	68676	293	69002	305	70047	104	72973	345	74225	319	74385	84
68323	290	68677	294	69003	306	70048	104	72974	345	74228	319	74386	84
68324	290	68678	294	69004	306	70049	104	72975	345	74231	319	74387	84
68325	290	68679	294	69005	306	70051	104	72976	345	74234	319	74388	84
68326	290	68680	294	69006	306	70053	104	72977	345	74237	319	74389	84
68327	290	68681	294	69007	306	70054	104	72978	113	74240	319	74390	84
68328	290	68682	294	69008	306	70056	104	72979	113	74243	319	74391	84
68329	290	68683	294	69009	306	70057	104	72980	113	74246	319	74392	84
68330	290	68684	294	69010	306	70059	104	72981	113	74249	322	74393	84
68331	291	68685	294	69011	306	70060	104	72982	113	74252	322	74394	84
68332	291	68686	294	69012	306	70062	104	72983	113	74255	322	74395	84
68333	291	68687	294	69013	306	70063	104	72984	113	74258	322	74396	84
68334	291	68688	294	69014	306	70065	104	72985	113	74261	322	74397	84
68335	291	68689	294	69015	306	70066	104	73012	338	74264	322	74398	84
68336	291	68690	294	69016	306	70068	104	73013	338	74267	322	74399	84
68337	291	68691	294	69017	306	70069	104	73014	338	74270	322	74400	84
68338	291	68692	294	69018	306	70070	103	73026	338	74300	84	74401	84
68339	291	68693	294	69019	306	70071	103	73027	338	74301	84	74402	84
68340	291	68694	294	69020	306	70072	103	73028	338	74302	84	74403	84
68341	291	68695	294	69021	306	70073	103	73029	338	74303	84	74404	84
68342	291	68696	294	69022	306	70074	103	73041	338	74304	84	74405	84
68343	291	68697	294	69023	306	70075	103	73070	339	74305	84	74406	84
68344	291	68698	294	69024	306	70076	103	73071	339	74306	84	74407	84
68345	291	68699	294	69025	306	70077	103	73072	339	74307	84	74408	84
68346	291	68700	294	69026	307	70078	103	73073	339	74308	84	74409	84
68347	291	68701	294	69027	307	70079	103	73074	339	74309	84	74410	84
68348	291	68702	294	69028	307	70080	103	73075	339	74310	84	74411	84
68349	291	68703	294	69029	307	70081	103	73078	339	74311	84	74412	84
68350	291	68704	294	69030	307	70082	103	73079	339	74316	84	74413	84
68351	291	68705	294	69031	307	70083	103	73080	339	74317	84	74414	84
68352	291	68706	294	69032	307	70084	103	73081	339	74318	84	74415	84
68353	291	68707	294	69033	307	70085	103	73082	339	74319	84	74416	84
68354	292	68708	294	69034	307	70086	103	73083	339	74320	84	74417	84
68355	292	68709	295	69035	307	70087	103	74001	316	74321	84	74418	84
68356	292	68710	295	69036	307	70088	103	74004	316	74322	84	74419	84
68357	292	68711	295	69037	307	70089	103	74007	316	74323	84	74420	84
68358	292	68712	295	69038	307	70527	104	74010	316	74324	84	74421	84
68359	292	68713	295	69039	307	70529	104	74013	316	74325	84	74422	84
68360	292	68718	295	69040	307	70531	104	74016	316	74326	84	74423	84
68361	292	68723	295	69041	307	70533	104	74019	316	74327	84	74424	84
68362	292	68728	295	69042	307	70535	104	74022	316	74332	84	74425	84
68363	292	68733	295	69043	307	70537	104	74025	319	74333	84	74426	84
68364	292	68738	295	69044	307	70539	104	74028	319	74334	84	74427	84
68365	292	68743	295	69045	307	70540	104	74031	319	74335	84	74428	84
68366	292	68748	295	69046	307	70542	104	74034	319	74336	84	74429	84
68603	295	68753	295	69047	307	70544	104	74037	319	74337	84	74430	84
68604	295	68758	295	69048	307	70546	104	74040	319	74338	84	74431	84
68606	295	68763	295	69049	307	70548	104	74043	319	74339	84	74432	84
68607	295	68768	295	69050	307	70550	104	74046	319	74340	84	74433	84
68608	295	68773	295	69051	307	70551	103	74049	322	74341	84	74434	84
68609	295	68778	295	69052	307	70552	103	74052	322	74342	84	74435	84
68611	295	68780	295	69053	307	70553	103	74055	322	74343	84	74436	84
68612	295	68965	304	69054	307	70554	103	74058	322	74348	84	74437	84
68613	295	68966	304	69055	307	70555	103	74061	322	74349	84	74438	84
68614	295	68967	304	69056	307	70556	103	74064	322	74350	84	74439	84
68616	295	68968	304	70003	326	70557	103	74067	322	74351	84	74440	84
68643	293	68969	304	70004	326	70558	103	74070	322	74352	84	74441	84
68644	293	68970	304	70005	326	70559	103	74101	316	74353	84	74442	84
68645	293	68971	304	70006	326	70560	103	74104	316	74354	84	74443	84
68646	293	68972	304	70007	326	70561	103	74107	316	74355	84	74444	84
68647	293	68973	304	70008	326	70562	103	74110	316	74356	84	74445	84
68648	293	68974	304	70009	326	70563	103	74113	316	74357	84	74446	84
68649	293	68975	304	70010	326	72930	338	74116	316	74358	84	74447	84
68650	293	68976	304	70011	326	72947	338	74119	316	74359	84	74448	84
68651	293	68977	304	70012	326	72948	338	74122	316	74360	84	74449	84
68652	293	68978	304	70013	326	72949	338	74125	319	74361	84	74450	84
68653	293	68979	304	70014	326	72950	338	74128	319	74362	84	74451	84
68654	293	68980	305	70015	326	72951	338	74131	319	74363	84	74452	84
68655	293	68981	305	70016	326	72952	338	74134	319	74364	84	74453	84
68656	293	68982	305	70017	326	72953	338	74137	319	74365	84	74454	84

EDP Number Index

EDP NO.	PAGE	EDP NO.	PAGE	EDP NO.	PAGE	EDP NO.	PAGE	EDP NO.	PAGE	EDP NO.	PAGE	EDP NO.	PAGE
74455	84	74543	85	77131	82	77219	82	77307	83	83041	338	91113	349
74456	85	74544	85	77132	82	77220	83	77308	83	83042	338	91121	349
74457	85	74545	85	77133	82	77221	83	77309	83	83043	338	91129	349
74458	85	74546	85	77134	82	77222	83	77310	83	83044	338	91137	349
74459	85	74547	85	77135	82	77223	83	77311	83	83056	113	91235	166
74460	85	74548	85	77136	82	77224	83	77312	83	83057	113	91236	166
74461	85	74549	85	77137	82	77225	83	77313	83	83058	113	91237	166
74462	85	74550	85	77138	82	77226	83	77314	83	83059	113	91238	166
74463	85	74551	85	77139	82	77227	83	77315	83	83060	113	91239	166
74464	85	74552	85	77140	82	77228	83	77316	83	83061	113	91240	166
74465	85	74553	85	77141	82	77229	83	77317	83	83062	113	91241	166
74466	85	74554	85	77142	82	77230	83	77318	83	83063	113	91242	166
74467	85	74555	85	77143	82	77231	83	77319	83	83064	113	91243	166
74468	85	74556	85	77144	82	77232	83	77320	83	83065	113	91244	166
74469	85	74557	85	77145	82	77233	83	77321	83	83070	338	91245	166
74470	85	74558	85	77146	82	77234	83	77322	83	83071	338	91246	166
74471	85	74559	85	77147	82	77235	83	77323	83	83072	338	91247	166
74472	85	74560	85	77148	82	77236	83	77324	83	83073	338	91248	166
74473	85	74561	85	77149	82	77237	83	77325	83	83100	338	91250	166
74474	85	74562	85	77150	82	77238	83	77326	83	83101	338	91251	166
74475	85	74563	85	77151	82	77239	83	77327	83	83102	338	91252	166
74476	85	74564	85	77152	82	77240	83	77328	83	83103	338	91253	166
74477	85	74565	85	77153	82	77241	83	77329	83	83104	338	91254	166
74478	85	74566	85	77154	82	77242	83	77330	83	83105	338	91255	166
74479	85	74567	85	77155	82	77243	83	77331	83	83106	338	91256	166
74480	85	74568	85	77156	82	77244	83	77332	83	83107	338	91257	166
74481	85	74569	85	77157	82	77245	83	77333	83	83108	338	91258	166
74482	85	74570	85	77158	82	77246	83	77334	83	83109	338	91259	166
74483	85	74571	85	77159	82	77247	83	77335	83	83110	338	91260	166
74484	85	74572	85	77160	82	77248	83	77336	83	83111	338	91261	166
74485	85	74573	85	77161	82	77249	83	77337	83	83200	342	91262	166
74486	85	74574	85	77162	82	77250	83	77338	83	83201	342	91263	166
74487	85	74575	85	77163	82	77251	83	77339	83	83202	342	91266	176
74488	85	74576	85	77164	82	77252	83	81001	330	83203	342	91268	195
74489	85	74577	85	77165	82	77253	83	81003	330	83204	342	91269	201
74490	85	74578	85	77166	82	77254	83	81005	330	83205	342	91270	176
74491	85	74579	85	77167	82	77255	83	81007	330	83206	342	91272	195
74492	85	74580	85	77168	82	77256	83	81009	330	83207	342	91273	201
74493	85	74581	85	77169	82	77257	83	81011	330	83220	339	91274	176
74494	85	74582	85	77170	82	77258	83	81013	330	83221	339	91276	195
74495	85	74583	85	77171	82	77259	83	81015	330	83222	339	91277	201
74496	85	74584	85	77172	82	77260	83	81017	330	83223	339	91278	176
74497	85	74585	85	77173	82	77261	83	81019	330	83224	339	91280	195
74498	85	74586	85	77174	82	77262	83	81021	330	83225	339	91281	201
74499	85	74587	85	77175	82	77263	83	81023	330	83230	339	91282	177
74500	85	74588	85	77176	82	77264	83	81025	330	83231	339	91284	196
74501	85	74589	85	77177	82	77265	83	81027	330	83232	339	91285	201
74502	85	74590	85	77178	82	77266	83	81029	330	83233	339	91286	177
74503	85	74591	85	77179	82	77267	83	82930	338	83234	339	91288	196
74504	85	74592	85	77180	82	77268	83	82931	338	83235	339	91290	177
74505	85	74593	85	77181	82	77269	83	82932	338	90001	348	91292	197
74506	85	74594	85	77182	82	77270	83	82933	338	90005	348	91349	107
74507	85	74595	85	77183	82	77271	83	82966	338	90009	348	91350	107
74508	85	74596	85	77184	82	77272	83	82967	338	90013	348	91351	107
74509	85	74597	85	77185	82	77273	83	82968	338	90017	348	91352	107
74510	85	74598	85	77186	82	77274	83	82969	338	90021	348	91353	107
74511	85	74599	85	77187	82	77275	83	82970	338	90025	348	91354	107
74512	85	77100	82	77188	82	77276	83	82971	338	90029	348	91355	107
74513	85	77101	82	77189	82	77277	83	82972	338	90033	348	91356	107
74514	85	77102	82	77190	82	77278	83	82973	338	90037	348	91357	107
74515	85	77103	82	77191	82	77279	83	82974	342	90041	348	91358	107
74516	85	77104	82	77192	82	77280	83	82975	342	90045	348	91359	107
74517	85	77105	82	77193	82	77281	83	82976	342	90049	348	91360	107
74518	85	77106	82	77194	82	77282	83	82977	342	90053	348	91361	107
74519	85	77107	82	77195	82	77283	83	82978	342	90101	348	93272	107
74520	85	77108	82	77196	82	77284	83	82979	342	90107	348	93273	107
74521	85	77109	82	77197	82	77285	83	82980	342	90109	348	93274	107
74522	85	77110	82	77198	82	77286	83	82981	342	90113	348	93275	107
74523	85	77111	82	77199	82	77287	83	82982	342	90121	348	93276	107
74524	85	77112	82	77200	82	77288	83	82983	342	90129	348	93277	107
74525	85	77113	82	77201	82	77289	83	82984	342	90137	348	93278	107
74526	85	77114	82	77202	82	77290	83	82985	342	91001	349	93279	107
74527	85	77115	82	77203	82	77291	83	82986	342	91005	349	93280	107
74528	85	77116	82	77204	82	77292	83	82987	342	91009	349	93281	107
74529	85	77117	82	77205	82	77293	83	82988	342	91013	349	93282	107
74530	85	77118	82	77206	82	77294	83	82989	342	91017	349		
74531	85	77119	82	77207	82	77295	83	82990	345	91021	349		
74532	85	77120	82	77208	82	77296	83	82991	345	91025	349		
74533	85	77121	82	77209	82	77297	83	82992	345	91029	349		
74534	85	77122	82	77210	82	77298	83	82993	345	91033	349		
74535	85	77123	82	77211	82	77299	83	82994	345	91037	349		
74536	85	77124	82	77212	82	77300	83	82995	345	91041	349		
74537	85	77125	82	77213	82	77301	83	82996	345	91045	349		
74538	85	77126	82	77214	82	77302	83	82997	345	91049	349		
74539	85	77127	82	77215	82	77303	83	83026	338	91053	349		
74540	85	77128	82	77216	82	77304	83	83027	338	91101	349		
74541	85	77129	82	77217	82	77305	83	83028	338	91107	349		
74542	85	77130	82	77218	82	77306	83	83029	338	91109	349		

KSPT Reference Information

ISO H6 SPECIFICATIONS					
DIAMETER	+	-	DIAMETER	+	-
≥ 1/8 - 3/16	0.00000	-0.00032	≤ 3	0,000	0,006
> 3/16 - 7/16	0.00000	-0.00035	> 3 - 6	0,000	0,008
> 7/16 - 5/8	0.00000	-0.00043	> 6 - 10	0,000	0,009
> 5/8 - 1	0.00000	-0.00051	> 10 - 18	0,000	0,011
> 1 - 1-1/4	0.00000	-0.00063	> 18 - 25	0,000	0,013

MACHINING FORMULAS	
INCH FORMULAS	METRIC FORMULAS
sfm = rpm x .262 x cutting diameter	m/min = (3.14 x cutting diameter x rpm) / 1000
rpm = sfm x 3.82 / cutting diameter	rpm = (1000 x m / min) / (3.14 x cutting diameter)
feed (inches per tooth) = ipm / (number of teeth x rpm)	feed (mm per tooth) = millimeters per minute / (number of teeth x rpm)
feed (inches / minute) = inches per tooth x number of teeth x rpm	feed (mm/minute) = feed per tooth x number of teeth x rpm
feed (inches / minute) = ipr x rpm	feed (mm/minute) = mmr x rpm
feed (inches / revolution) = ipm / rpm	feed (mm per revolution) = mmr / rpm
cuspl height* = (tool diameter / 2) - $\sqrt{(\text{tool diameter}^2 - \text{pitch}^2) / 4}$	cuspl height* = (tool diameter / 2) - $\sqrt{(\text{tool diameter}^2 - \text{pitch}^2) / 4}$
pitch = $\sqrt{4 \times (\text{cuspl height} \times \text{tool diameter}) - 4 \times (\text{cuspl height}^2)}$	pitch = $\sqrt{4 \times (\text{cuspl height} \times \text{tool diameter}) - 4 \times (\text{cuspl height}^2)}$
mrr – milling – (in ³ /min) = width of cut x depth of cut x ipm	mrr – milling – (cm ³ /min) = (width of cut x depth of cut x mm/min) / 1000
cutting time – drilling – (minutes) = length / ipm	cutting time – drilling – (minutes) = length / mm/min

sfm	surface feet per minute
rpm	revolutions per minute
ipm	feed rate in inches per minutes
ipr	inches per revolution
mmr	millimeters per revolution
mm/min	feed rate in millimeters per minute
mrr	material removal rate
*	on flat surface

GENERAL FORMULAS	
coolant pressure: 1 Bar = 14.5 Pounds per Square Inch (PSI)	
calculation of coolant pressure: Pounds Per Square Inch (PSI) = (Horsepower of Pump x 1.460) / Gallons per Minute (GPM)	
1 Liter = 0.254 Gallons	
inch = millimeters / 25.4	millimeters = inch x 25.4
inch tap drill sizes = major diameter - ((1.299 x % of thread) / threads per inch)	
metric tap drill sizes = major diameter - (1.082 x pitch x % of thread)	
inch thread forming drill size: maximum diameter = basic major diameter - (3/8 x number of threads per inch)	
inch thread forming drill size: minimum diameter = basic major diameter - (1/2 x number of threads per inch)	
metric thread forming drill size: maximum diameter = basic major diameter - (.375 x pitch)	
metric thread forming drill size: minimum diameter = basic major diameter - (.500 x pitch)	

Decimal Equivalents

Fraction • Number • Letter • Metric Sizes

INCH	METRIC	DECIMAL EQUIVALENT	INCH	METRIC	DECIMAL EQUIVALENT	INCH	METRIC	DECIMAL EQUIVALENT	INCH	METRIC	DECIMAL EQUIVALENT	INCH	METRIC	DECIMAL EQUIVALENT	INCH	METRIC	DECIMAL EQUIVALENT
-	0,10	0.0039	-	1,60	0.0630	9/64	3,57	0.1406	#1	5,79	0.2280	R	8,61	0.3390	-	13,00	0.5118
-	0,20	0.0079	#52	1,61	0.0635	-	3,60	0.1417	-	5,80	0.2283	-	8,70	0.3425	33/64	13,10	0.5156
-	0,25	0.0098	-	1,65	0.0650	#27	3,66	0.1440	-	5,90	0.2323	11/32	8,73	0.3438	17/32	13,49	0.5312
-	0,30	0.0118	#51	1,70	0.0669	-	3,70	0.1457	A	5,94	0.2340	-	8,75	0.3445	-	13,50	0.5315
#80	0,34	0.0135	-	1,75	0.0689	#26	3,73	0.1470	15/64	5,95	0.2344	-	8,80	0.3465	35/64	13,89	0.5469
-	0,35	0.0138	#50	1,78	0.0700	-	3,75	0.1476	-	6,00	0.2362	S	8,84	0.3480	-	14,00	0.5512
#79	0,37	0.0145	-	1,80	0.0709	#25	3,80	0.1495	B	6,05	0.2380	-	8,90	0.3504	9/16	14,29	0.5625
1/64	0,40	0.0156	#49	1,85	0.0728	-	3,80	0.1496	-	6,10	0.2402	-	9,00	0.3543	-	14,50	0.5709
#78	0,41	0.0160	-	1,90	0.0748	#24	3,86	0.1520	C	6,15	0.2420	T	9,09	0.3580	37/64	14,68	0.5781
-	0,45	0.0177	#48	1,93	0.0760	-	3,90	0.1535	-	6,20	0.2441	-	9,10	0.3583	-	15,00	0.5906
#77	0,46	0.0180	-	1,95	0.0768	#23	3,91	0.1540	D	6,25	0.2461	23/64	9,13	0.3594	19/32	15,08	0.5938
-	0,50	0.0197	5/64	1,98	0.0781	5/32	3,97	0.1562	-	6,30	0.2480	-	9,20	0.3622	39/64	15,48	0.6094
#76	0,51	0.0200	#47	1,99	0.0785	#22	3,99	0.1570	E	6,35	0.2500	-	9,25	0.3642	-	15,50	0.6102
#75	0,53	0.0210	-	2,00	0.0787	-	4,00	0.1575	1/4	6,35	0.2500	-	9,30	0.3661	5/8	15,88	0.6250
-	0,55	0.0217	-	2,05	0.0807	#21	4,04	0.1590	-	6,40	0.2520	U	9,35	0.3680	-	16,00	0.6299
#74	0,57	0.0225	#46	2,06	0.0810	#20	4,09	0.1610	-	6,50	0.2559	-	9,40	0.3701	41/64	16,27	0.6406
-	0,60	0.0236	#45	2,08	0.0820	-	4,10	0.1614	F	6,53	0.2570	-	9,50	0.3740	-	16,50	0.6496
#73	0,61	0.0240	-	2,10	0.0827	-	4,20	0.1654	-	6,60	0.2598	3/8	9,53	0.3750	21/32	16,67	0.6562
#72	0,64	0.0250	-	2,15	0.0846	#19	4,22	0.1660	G	6,63	0.2610	V	9,56	0.3770	-	17,00	0.6693
-	0,65	0.0256	#44	2,18	0.0860	-	4,25	0.1673	-	6,70	0.2638	-	9,60	0.3780	43/64	17,07	0.6719
#71	0,66	0.0260	-	2,20	0.0866	-	4,30	0.1693	17/64	6,75	0.2656	-	9,70	0.3819	11/16	17,46	0.6875
-	0,70	0.0276	-	2,25	0.0886	#18	4,31	0.1695	H	6,76	0.2660	-	9,75	0.3839	-	17,50	0.6890
#70	0,71	0.0280	#43	2,26	0.0890	11/64	4,37	0.1719	-	6,80	0.2677	W	9,80	0.3858	45/64	17,86	0.7031
#69	0,74	0.0292	-	2,30	0.0906	#17	4,39	0.1730	-	6,90	0.2717	-	9,90	0.3898	-	18,00	0.7087
-	0,75	0.0295	-	2,35	0.0925	-	4,40	0.1732	I	6,91	0.2720	25/64	9,92	0.3906	23/32	18,26	0.7188
#68	0,79	0.0310	#42	2,37	0.0935	#16	4,50	0.1770	-	7,00	0.2756	-	10,00	0.3937	-	18,50	0.7283
1/32	0,79	0.0313	3/32	2,38	0.0938	-	4,50	0.1772	J	7,04	0.2770	X	10,08	0.3970	47/64	18,65	0.7344
-	0,80	0.0315	-	2,40	0.0945	#15	4,57	0.1800	-	7,10	0.2795	-	10,10	0.3976	-	19,00	0.7480
#67	0,81	0.0320	#41	2,44	0.0960	-	4,60	0.1811	K	7,14	0.2810	-	10,20	0.4016	3/4	19,05	0.7500
#66	0,84	0.0330	-	2,45	0.0965	#14	4,62	0.1820	9/32	7,14	0.2812	Y	10,26	0.4040	49/64	19,45	0.7656
-	0,85	0.0335	#40	2,50	0.0984	#13	4,70	0.1850	-	7,20	0.2835	-	10,30	0.4055	-	19,50	0.7677
#65	0,89	0.0350	#39	2,53	0.0995	-	4,75	0.1870	-	7,25	0.2854	13/32	10,32	0.4062	25/32	19,84	0.7812
-	0,90	0.0354	#38	2,58	0.1015	3/16	4,76	0.1875	-	7,30	0.2874	-	10,40	0.4094	-	20,00	0.7874
#64	0,91	0.0360	-	2,60	0.1024	#12	4,80	0.1890	L	7,37	0.2900	Z	10,49	0.4130	51/64	20,24	0.7969
#63	0,94	0.0370	#37	2,64	0.1040	#11	4,85	0.1910	-	7,40	0.2913	-	10,50	0.4134	-	20,50	0.8071
-	0,95	0.0374	-	2,70	0.1063	-	4,90	0.1929	M	7,49	0.2950	-	10,60	0.4173	13/16	20,64	0.8125
#62	0,97	0.0380	#36	2,71	0.1065	#10	4,91	0.1935	-	7,50	0.2953	-	10,70	0.4213	-	21,00	0.8268
#61	0,99	0.0390	-	2,75	0.1083	#9	4,98	0.1960	19/64	7,54	0.2969	27/64	10,72	0.4219	53/64	21,03	0.8281
-	1,00	0.0394	7/64	2,78	0.1094	-	5,00	0.1969	-	7,60	0.2992	-	10,80	0.4252	27/32	21,43	0.8438
#60	1,02	0.0400	#35	2,79	0.1100	#8	5,05	0.1990	N	7,67	0.3020	-	10,90	0.4291	-	21,50	0.8465
#59	1,04	0.0410	-	2,80	0.1102	-	5,10	0.2008	-	7,70	0.3031	-	11,00	0.4331	55/64	21,84	0.8594
-	1,05	0.0413	#34	2,82	0.1110	#7	5,11	0.2010	-	7,75	0.3051	-	11,10	0.4370	-	22,00	0.8661
#58	1,07	0.0420	#33	2,87	0.1130	13/64	5,16	0.2031	-	7,80	0.3071	7/16	11,11	0.4375	7/8	22,23	0.8750
#57	1,09	0.0430	-	2,90	0.1142	#6	5,18	0.2040	-	7,90	0.3110	-	11,20	0.4409	-	22,50	0.8858
-	1,10	0.0433	#32	2,95	0.1160	-	5,20	0.2047	5/16	7,94	0.3125	-	11,30	0.4449	57/64	22,62	0.8906
-	1,15	0.0453	-	3,00	0.1181	#5	5,22	0.2055	-	8,00	0.3150	-	11,40	0.4488	-	23,00	0.9055
#56	1,18	0.0465	#31	3,05	0.1200	-	5,25	0.2067	O	8,03	0.3160	-	11,50	0.4528	29/32	23,02	0.9062
3/64	1,19	0.0469	-	3,10	0.1220	-	5,3	0.2087	-	8,10	0.3189	29/64	11,51	0.4531	59/64	23,42	0.9219
-	1,20	0.0472	1/8	3,18	0.1250	#4	5,31	0.2090	-	8,20	0.3228	-	11,60	0.4567	-	23,50	0.9252
-	1,25	0.0492	-	3,20	0.1260	-	5,40	0.2126	P	8,20	0.3230	-	11,70	0.4606	15/16	23,81	0.9375
-	1,30	0.0512	-	3,25	0.1280	#3	5,41	0.2130	-	8,25	0.3248	-	11,80	0.4646	-	24,00	0.9449
#55	1,32	0.0520	#30	3,26	0.1285	-	5,50	0.2165	-	8,30	0.3268	-	11,90	0.4685	61/64	24,21	0.9531
-	1,35	0.0531	-	3,30	0.1299	7/32	5,56	0.2188	21/64	8,33	0.3281	15/32	11,91	0.4688	-	24,50	0.9646
#54	1,40	0.0550	-	3,40	0.1339	-	5,60	0.2205	-	8,40	0.3307	-	12,00	0.4724	31/32	24,61	0.9688
#53	1,51	0.0595	#29	3,45	0.1360	#2	5,61	0.2210	Q	8,43	0.3320	31/64	12,30	0.4844	-	25,00	0.9843
-	1,55	0.0610	-	3,50	0.1378	-	5,70	0.2244	-	8,50	0.3346	-	12,50	0.4921	63/64	25,00	0.9844
1/16	1,59	0.0625	#28	3,57	0.1405	-	5,75	0.2264	-	8,60	0.3386	1/2	12,70	0.5000	1	25,40	1.0000