

THE NEW VALUE FRONTIER



90° Milling with Double Sided 4-edge Inserts

MEW

90° Milling with Double Sided 4-edge Inserts

MEW Series

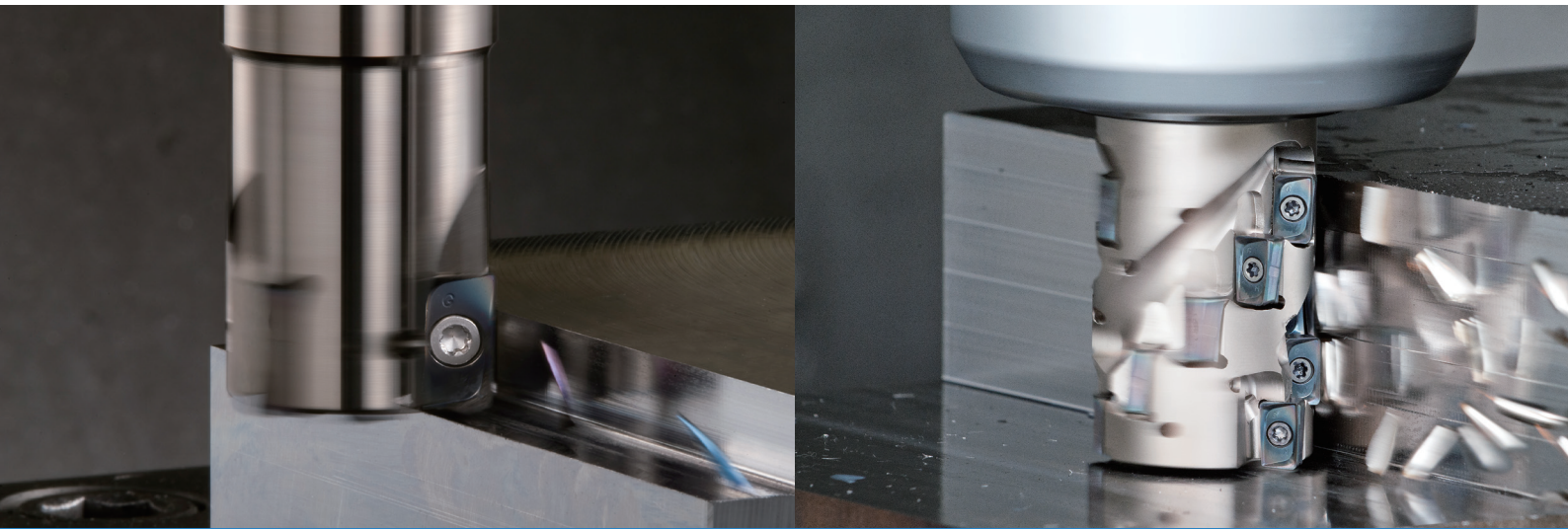

Low Cutting Forces Equivalent to Positive Inserts with Chattering Resistance for Excellent Surface Finish

Economical 4-edge Insert

MEWH Helical End Mill Added

Improved Toolholder Durability and Insert Installation Accuracy

NEW

DLC Coating for Machining Aluminum
Grade PDL025 Added to the Lineup



90° End Mill with Double Sided 4-edge Insert

MEW

Low Cutting Forces Equivalent to Positive Inserts with Chattering Resistance for Excellent Surface Finish
 DLC Coating PDL025 for Machining Aluminum Added to the Lineup for a Wide Range of Milling Applications

1 Low Cutting Forces Equivalent to Positive Inserts

Kyocera's unique insert-forming technology reduces cutting forces equivalent to positive inserts

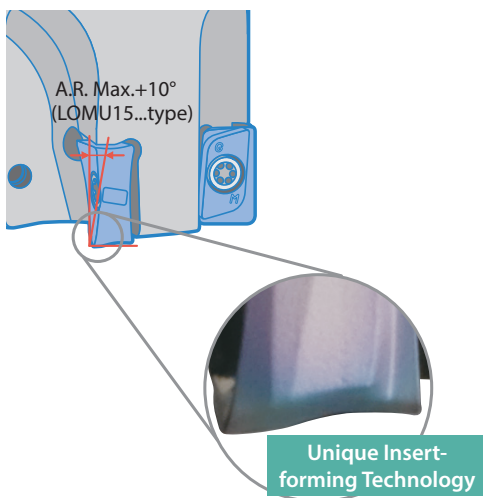

Cutting Force Comparison (In-house Evaluation)

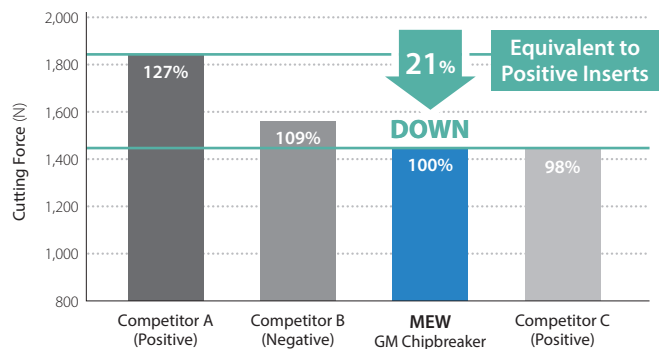

Cutting force is the resultant force of the principal force and the feed force

Cutting Conditions : $V_c = 150$ m/min, $f_z = 0.15$ mm/t, $a_p \times a_e = 3 \times 15$ mm
 Cutter Dia. $\phi 20$ mm Workpiece : S50C

2 Excellent Fracture Resistance

Obtuse edge for increased cutting edge toughness for stable machining at high feed rates

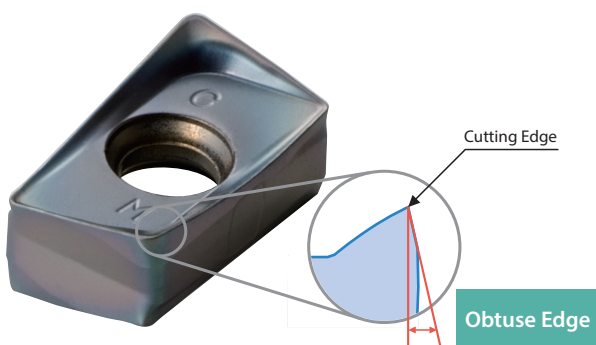

Fracture Resistance Comparison (In-house Evaluation)

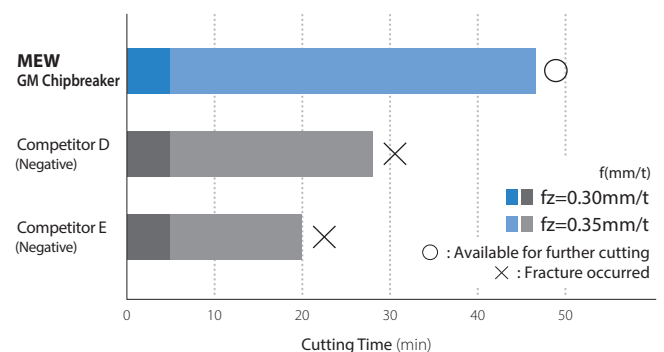

Cutting Conditions : $V_c = 120$ m/min, $f_z = 0.3 - 0.35$ mm/t, $a_p \times a_e = 3 \times 10$ mm
 Cutter Dia. $\phi 20$ mm Workpiece : SCM440H (37 - 39HS)

3 Improved Surface Finish & Minimized Vibration

Sharp cutting and superior resistance to vibration and burrs due to helical cutting edge and optimum axial rake design

Surface of Shoulder Wall (In-house Evaluation)

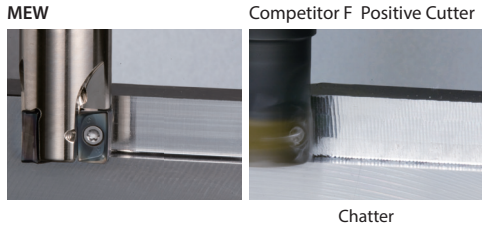

Cutting Conditions : Vc = 240 m/min, fz = 0.12 mm/t, ap x ae = 4 x 5 mm
Cutter Dia. ø20 mm, Dry Workpiece : S5400

Burr Comparison with Positive Cutters (In-house Evaluation)

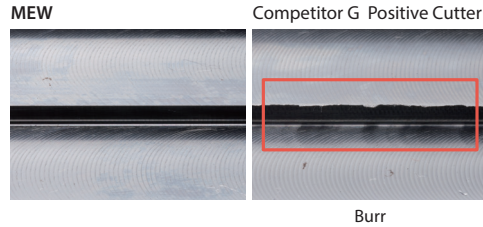

Cutting Conditions : Vc = 250 m/min, fz = 0.1 mm/t, ap x ae = 4 x 5 mm
Cutter Dia. ø20 mm, Dry Workpiece : S50C

Actual Rake Angle (In-house Evaluation)

MEW GM Chipbreaker	+20°
Competitor H (Negative)	+17°
Competitor I (Positive)	+17°

4 Improved Toolholder Durability and Insert Installation Accuracy

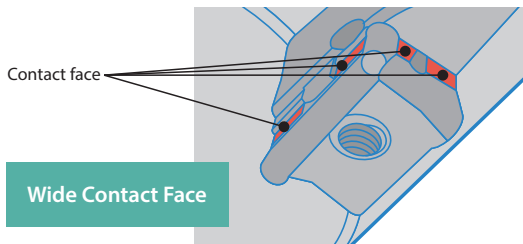

5 Various Chipbreakers for a Wide Range of Applications

4 types of chipbreakers for a wide range of applications along with a large lineup of corner R (rε) for the GM chipbreaker

Chipbreaker	Application	Shape
GM	General Purpose	
SM	Low cutting force	
GH	Heavy milling	
AM	Non-ferrous Metals • Aluminum	

Chipbreaker Recommended Applications (Shouldering)

LOMU10type

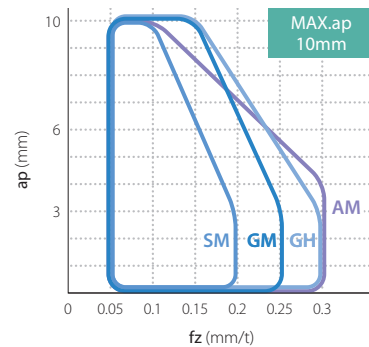

LOMU15type

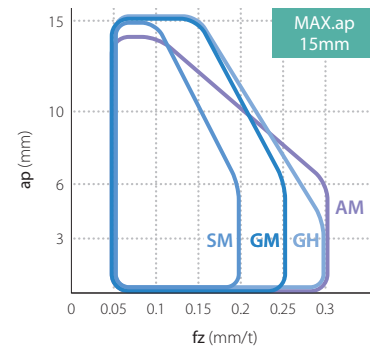

Chips (GM Chipbreaker)

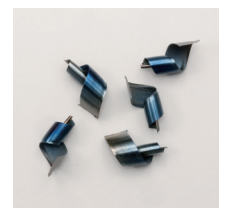

Grooving



Shouldering

NEW

90° Helical End Mill with Double Sided 4-edge Inserts

MEWH

Excellent Surface Finish and Stable Machining due to the Innovative Toolholder Design
Economical 4-edge Inserts

1 Improved Surface Finish & Minimized Vibration

Better Surface Quality than Competitor

Surface Finish Comparison (In-house Evaluation)

MEWH

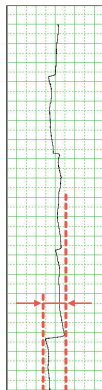
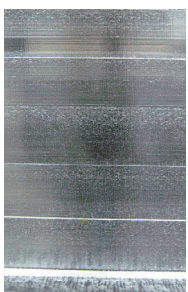

Smooth Surface Finish



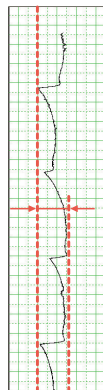



Competitor J



Cutting Conditions : $V_c = 120$ m/min, $f_z = 0.1$ mm/t, $a_p \times a_e = 45 \times 5$ mm, Dry
MEWH040S32-10-5-3T LOMU100408ER-GM (PR1525)
Workpiece : SCM435

2 Excellent Chip Evacuation

Chips are constantly evacuated in the opposite direction of the cutter feed without clogging

Chipbreaker	Workpiece	$f_z = 0.15$ mm/t	$f_z = 0.2$ mm/t
GM	SCM435		
GM	SS400		
SM			



Cutting Conditions : $V_c = 120$ m/min, $a_p \times a_e = 20 \times 15$ mm, Dry

MEGACOAT NANO PR1535

Fracture resistant with a tough substrate and high heat-resistant coating
Stable machining of general steel, mold steel, and difficult-to-cut materials

1 Toughening by a New Cobalt Mixing Ratio *In-house Evaluation

High Toughness Carbide Base Material

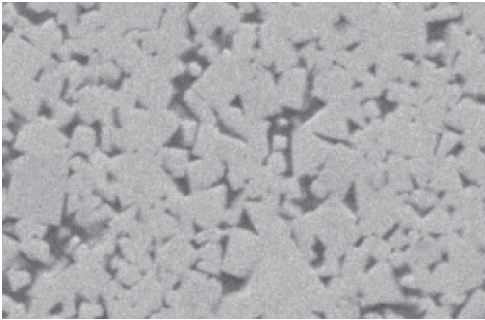

UP
23%
Fracture
Toughness*

2 Stability Improvement

The coarse grain structure and uniform particle size correspond to improved heat resistance, with conductivity values decreased by 11%. The uniform structure also reduces crack propagation.

UP
Shock
Resistance

Cracking Comparison by Diamond Indenter (In-house Evaluation)

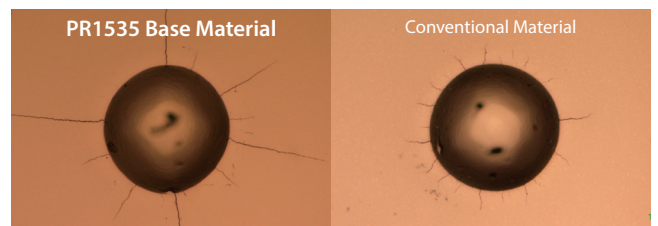

Short Cracks

Long Cracks

Coating Properties (Abrasion Resistance)

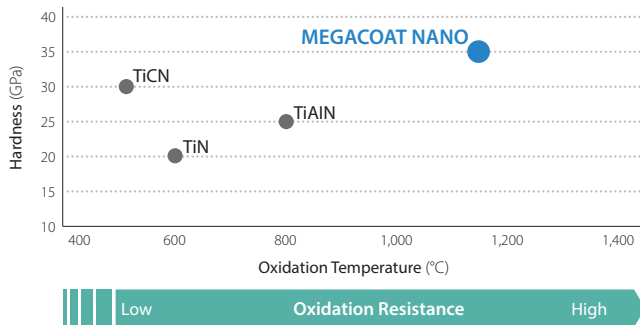

Achieve long tool life with the combination of a tough substrate and a special Nano coating layer

Coating Properties (Deposition Resistance)

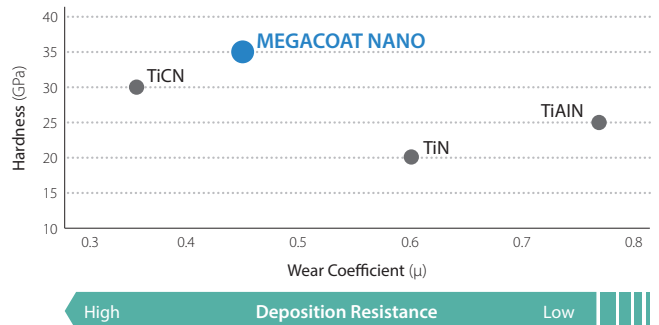

Stable Machining with Excellent Wear Resistance

NEW DLC Coated Carbide PDL025

High Quality and Long Tool Life for Machining Aluminum
High Hardness with Kyocera's Proprietary Hydrogen-free DLC Coating

Coating Properties

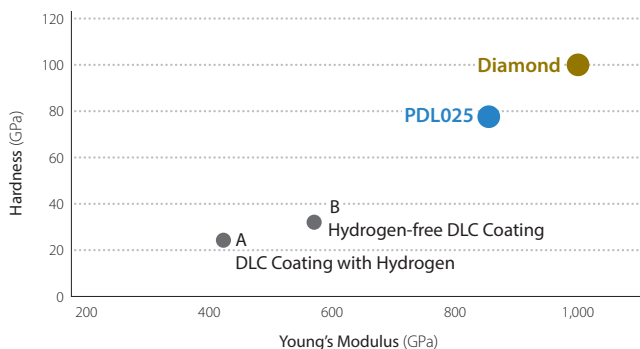

Deposition Resistance Comparison (In-house Evaluation)

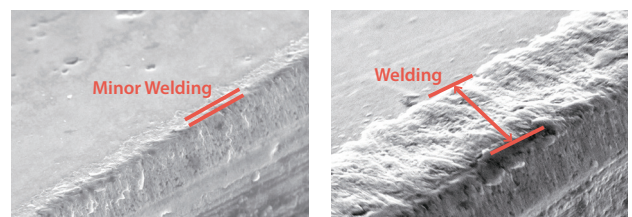

PDL025

Competitor K

Cutting Conditions : Vc = 800 m/min, fz = 0.1 mm/t, ap x ae = 3 x 5 mm, Dry
Cutter Dia. ø25 mm Workpiece : A5052 Cutting Length : 57 mm

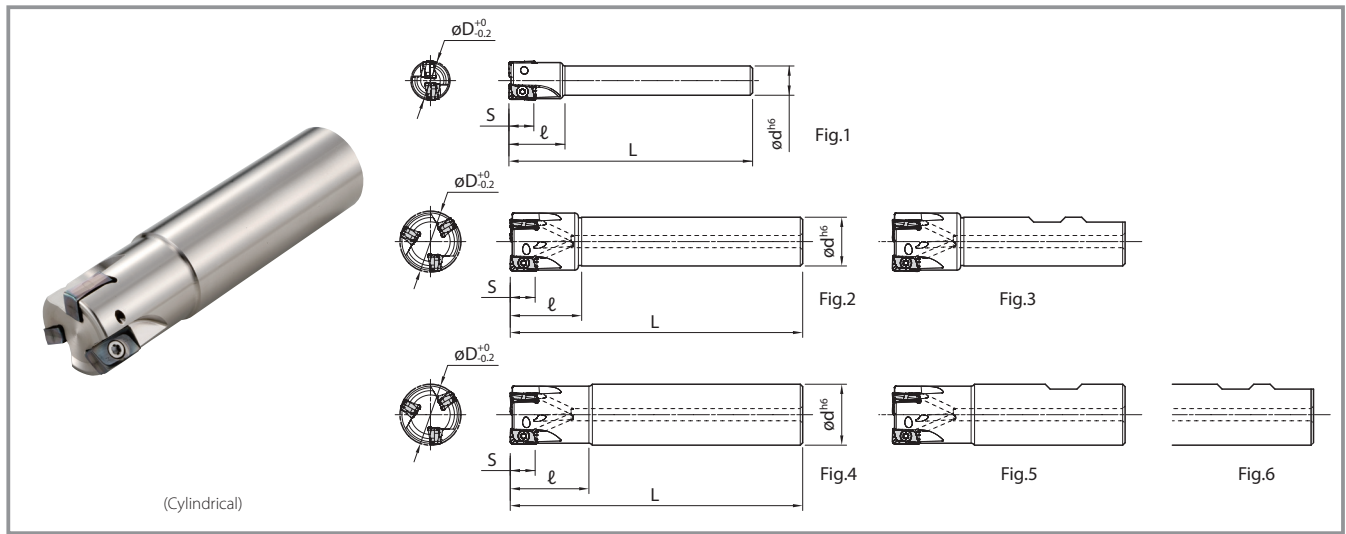

Dimensions

	Description	Stock	No. of Inserts	Dimensions (mm)					A.R.		Coolant Hole	Shape	Max.Revolution (min-1)						
				ϕD	ϕd	L	ℓ	S	A.R.(MAX.)	R.R.									
Cylindrical	Standard (Straight)	MEW 16-S12-10-2T	●	2	16	12	100	23	10	+7°	-20°	Yes	Fig.1	43,750					
		MEW 18-S16-10-2T	●		18	16		25						43,000					
		MEW 20-S16-10-2T	●	20	110	26	41,000												
		MEW 22-S20-10-3T	●	22	20	120	29	39,600											
		MEW 25-S20-10-3T	●	25	130	32	37,500												
		MEW 28-S25-10-3T	●	28	150	50	35,800												
		MEW 30-S25-10-4T	●	30	25	130	32	34,800											
		MEW 32-S25-10-4T	●	32	150	50	33,900												
		MEW 40-S32-10-5T	●	40	32	120	40	30,000											
		MEW 50-S32-10-5T	●	50	120	40	22,500												
	Same Shank Size (Straight)	MEW 16-S16-10-2T	●	2	16	16	100	26	10	+7°	-20°	Yes	Fig.4	43,750					
		MEW 20-S20-10-2T	●	20	20	110	30	41,000											
		MEW 20-S20-10-3T	●	3	25	25	120	32						41,000					
		MEW 25-S25-10-2T	●	2	25	25	120	32						37,500					
		MEW 25-S25-10-3T	●	3	32	32	130	40						37,500					
		MEW 32-S32-10-3T	●	3	32	32	130	40						33,900					
		MEW 32-S32-10-4T	●	4	32	32	130	40						33,900					
		MEW 20-S20-10-150-2T	●	2	20	20	150	40						10	+7°	-20°	Yes	Fig.4	41,000
	MEW 25-S25-10-170-2T	●	2	25	25	170	50	10	+7°	-20°	Yes	Fig.4	37,500						
	Standard (Straight)	MEW 25-S20-15-2T	●	2	25	20	120	29	15	+10°	-22°	Yes	Fig.2	35,000					
MEW 32-S25-15-2T		●	2	32	25	130	32	30,000											
MEW 40-S32-15-3T		●	3	40	32	150	50	15						+10°	-21°	Yes	Fig.2	25,000	
MEW 40-S32-15-4T		●	4	50	32	120	40											25,000	
MEW 50-S32-15-4T		●	4	50	32	120	40											17,000	
MEW 25-S25-15-2T		●	2	25	25	120	32											15	+10°
MEW 32-S32-15-2T	●	2	32	32	130	40	30,000												
MEW 32-S32-15-3T	●	3	32	32	130	40	30,000												
Standard (Weldon)	Standard (Weldon)	MEW 40-W32-10-5T	BTO	5	40	32	111	50	10	+7°	-19°	Yes	Fig.3	30,000					
		MEW 40-W32-15-4T	BTO	4	40	32	111	50	15	+10°	-21°			25,000					
	Same Shank Size (Weldon)	MEW 16-W16-10-2T	BTO	2	16	16	75	10	+7°	-20°	Yes	Fig.5	43,750						
		MEW 20-W20-10-2T	BTO	2	20	20	77						25	41,000					
		MEW 20-W20-10-3T	BTO	3	25	25	90						32	41,000					
		MEW 25-W25-10-2T	BTO	2	25	25	90						32	10	+7°	-20°	Yes	Fig.6	37,500
		MEW 25-W25-10-3T	BTO	3	32	32	102						40						37,500
		MEW 32-W32-10-4T	BTO	4	32	32	102						40						33,900
		MEW 25-W25-15-2T	BTO	2	25	25	90						32						15
		MEW 32-W32-15-3T	BTO	3	32	32	102						40	30,000					

Caution with Max. Revolution
When running cutters at the maximum revolution, the insert or toolholder may be damaged by centrifugal force.

● : Standard Stock
BTO : Build to Order

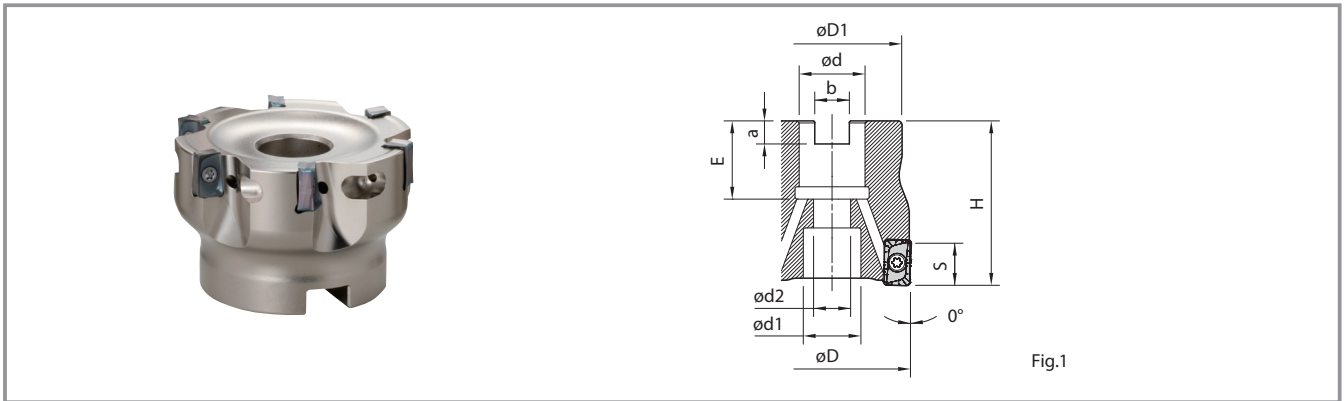

Fig.1

Dimensions

Description	Stock	No. of Inserts	Dimensions (mm)										A.R.		Coolant Hole	Shape	Weight (kg)	Max.Revolution (min-1)	
			øD	øD1	ød	ød1	ød2	H	E	a	b	S	A.R. (MAX.)	R.R.					
MEW 032R-10-4T-M	●	4	32	30	16	14	9	35	19	5.6	8.4	10	+7°	-20°	Yes	Fig.1	0.1	33,900	
MEW 040R-10-5T-M	●	5	40	34				40									0.2	30,000	
MEW 050R-10-5T-M	●		50	45	22	18	11	40	21	6.3	10.4	15	+10°	-19°	Yes	Fig.1	0.4	22,500	
MEW 063R-10-6T-M	●	6	63	47													0.5	20,500	
MEW 040R-15-4T-M	●	4	40	34	16	14	9	40	19	5.6	8.4	15	+10°	-21°	Yes	Fig.1	0.2	25,000	
MEW 050R-15-4T-M	●		50	45													0.3	17,000	
MEW 063R-15-5T-M	●	5	63	47	27	20	13	50	25	7	12.4	15	+10°	-20°	Yes	Fig.1	0.5	14,500	
MEW 080R-15-6T-M	●	6	80	60													25.4	20	13
MEW 080R-15-6T	●																		

Caution with Max. Revolution

When running an end mill or a cutter at the maximum revolution, the insert or cutter may be damaged by centrifugal force.

● : Standard Stock

Spare Parts and Applicable Inserts (Common to End Mill and Face Mill)

Description	Spare Parts				Applicable Inserts			
	Clamp Screw	Wrench	Anti-Seize Compound	Mounting Bolt				
MEW ...-10-_T	SB-3065TRP	DTPM-8	P-37	—	LOMU 1004 · ER-GM	LOMU 100408ER-SM	LOMU 100408ER-GH	LOGT 100408FR-AM
MEW 032R-10-4T-M				HH8×25				
MEW 040R-10-5T-M				HH10×30				
MEW 050R-10-5T-M				HH10×30				
MEW 063R-10-6T-M	Recommended torque for insert clamp 1.2N · m							
MEW ...-15-_T	SB-4090TRP	DTPM-15	P-37	—	LOMU 1505 · ER-GM	LOMU 150508ER-SM	LOMU 150508ER-GH	LOGT 150508FR-AM
MEW 040R-15-4T-M				HH8×25				
MEW 050R-15-4T-M				HH10×30				
MEW 063R-15-5T-M				HH10×30				
MEW 080R-15-6T(-M)	Recommended torque for insert clamp 3.5N · m			HH12×35				

Coat Anti-seize Compound (MP-1) thinly on portion of taper and thread prior to installation.

Recommended Cutting Conditions → P14

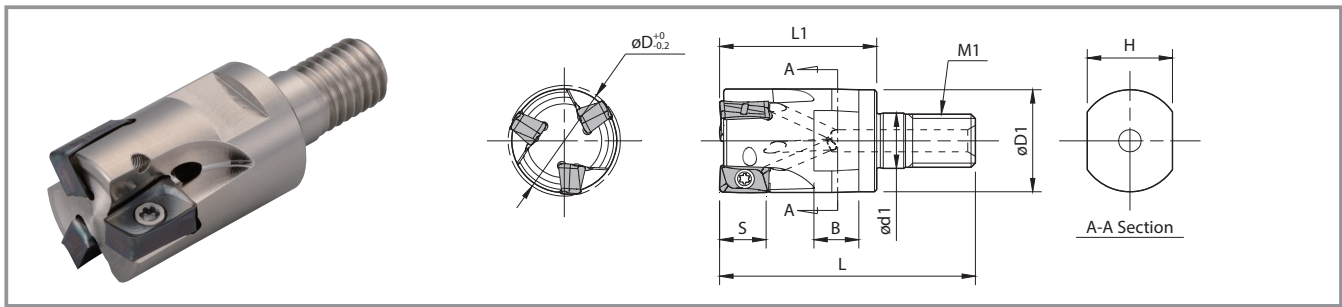

Dimensions

Description	Stock	No. of Inserts	Dimensions (mm)									A.R.		Coolant Hole	Applicable Inserts	Max.Revolution (min-1)		
			ϕD	$\phi D1$	$\phi d1$	L	L1	M1	H	B	S	A.R. (MAX.)	R.R.					
MEW 16-M08-10-2T	●	2	16	14.7	8.5	43	25	M8×P1.25	12	8	10	+7°	-22°	Yes	LOMU1004 LOGT1004	43,750		
20-M10-10-2T	●		20	18.7	10.5	49	30	M10×P1.5	15	9						41,000		
20-M10-10-3T	●	25	23	12.5	57	35	M12×P1.75	19	10	41,000								
25-M12-10-3T	●	3	25	23	12.5	57	35	M12×P1.75	19	10		+7°	-20°			Yes	LOMU1505 LOGT1505	37,500
32-M16-10-4T	●		32	30	17	63	40	M16×P2.0	24	12								33,900
MEW 25-M12-15-2T	●	2	25	23	12.5	57	35	M12×P1.75	19	10		15	+10°					-22°
32-M16-15-3T	●	32	30	17	63	40	M16×P2.0	24	12	30,000								

Caution with Max. Revolution
When running an end mill or a cutter at the maximum revolution, the insert or cutter may be damaged by centrifugal force.

● : Standard Stock

Spare Parts and Applicable Inserts

Description	Spare Parts			Applicable Inserts			
	Clamp Screw	Wrench	Anti-Seize Compound				
MEW 16-M08-10-2T 20-M10-10-2T 20-M10-10-3T 25-M12-10-3T 32-M16-10-4T	SB-3065TRP Recommended torque for insert clamp 1.2N·m	DTPM-8	P-37	LOMU 1004 · ER-GM	LOMU 100408ER-SM	LOMU 100408ER-GH	LOGT 100408FR-AM
MEW 25-M12-15-2T 32-M16-15-3T	SB-4090TRP Recommended torque for insert clamp 3.5N·m	DTPM-15	P-37	LOMU 1505 · ER-GM	LOMU 150508ER-SM	LOMU 150508ER-GH	LOGT 150508FR-AM

Coat Anti-seize Compound thinly on portion of taper and thread when insert is fixed.

Modular End Mill Head Identification System

MEW 16 - M08 - 10 - 2T
 Series Cutting Dia. Thread Size for Clamping Insert Size No. of inserts

Wrenches and clamp screws are "Torx Plus".

- See Fig. 1 for "Torx Plus" Wrench. (Purple Grip)
- See Fig. 2 for "Torx" Wrench. (Black Grip)

"Torx Plus" Wrench and "Torx" Wrench have different top shapes. Please use a "Torx Plus" Wrench.

If a "Torx" Wrench is used to tighten, the screw head might become damaged and then the screw cannot be removed.

Fig. 1 "Torx Plus" Wrench (For MEW)

Fig. 2 "Torx" Wrench (Do NOT use it for MEW)

BT Arbor (for exchangeable head/two face contact)

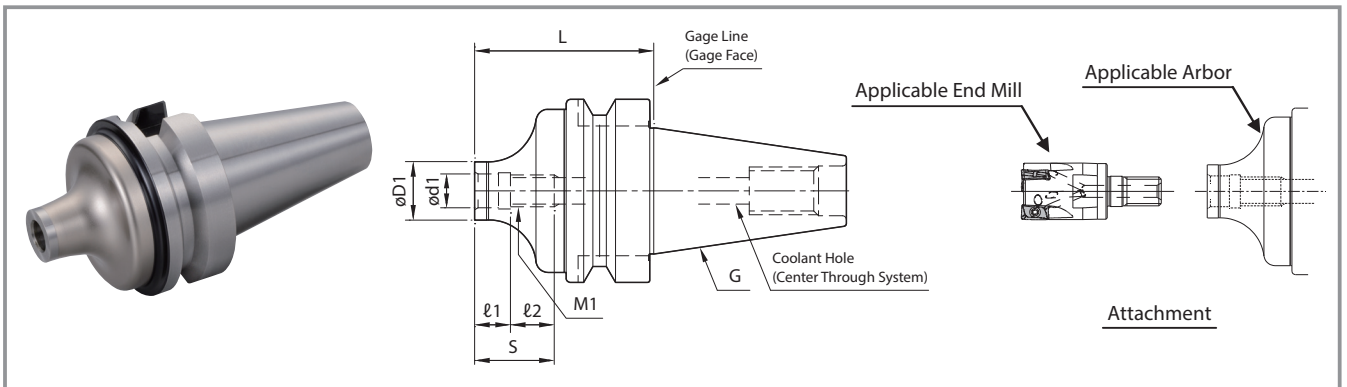

Dimensions

Description	Stock	Dimensions (mm)							Coolant Hole	Arbor(Two-face clamping) G	Applicable End Mill (Head)
		L	øD1	ød1	S	ℓ1	ℓ2	M1			
BT30K- M08-45	●	45	14.7	8.5	20	9	11	M8×P1.25	Yes	BT30	MEW16-M08-
	●		18.7	10.5	21		12	M10×P1.5			MEW20-M10-
	●		23	12.5	24		15	M12×P1.75			MEW25-M12-
BT40K- M08-55	●	55	14.7	8.5	20	9	11	M8×P1.25	Yes	BT40	MEW16-M08-
	●	60	18.7	10.5	21		12	M10×P1.5			MEW20-M10-
	●	55	23	12.5	24		15	M12×P1.75			MEW25-M12-
	●	65	30	17	25		16	M16×P2.0			MEW32-M16-

●: Standard Stock

Actual End Mill Depth

Arbor Description	Applicable End Mill (Head)			Actual End Mill Depth (mm)	
	Description	Cutting Dia.	Dimension	M	L2
		øD	L1		
BT30K- M08-45	MEW16-M08-	ø16	25	31.8	6.8
	MEW20-M10-	ø20	30	36.8	6.8
	MEW25-M12-	ø25	35	42.8	7.8
BT40K- M08-55	MEW16-M08-	ø16	25	31.7	6.7
	MEW20-M10-	ø20	30	38.7	8.7
	MEW25-M12-	ø25	35	44.6	9.6
	MEW32-M16-	ø32	40	51.2	11.2

Arbor Identification System

BT30 **K** - **M08** - **45**

Arbor Size Two-Face Clamping Spindle Thread Size for Clamping Length from the Gage

Advantages of the Modular MEW

BT30 M/C (Two-face Clamping Spindle) + Cutting Dia. : $\varnothing 20$ Comparison with MEW End Mill

1 Low Gage Line Reduces Chattering

The distance from the cutting edge to the gage line is shorter with the same overhang length (30 mm)

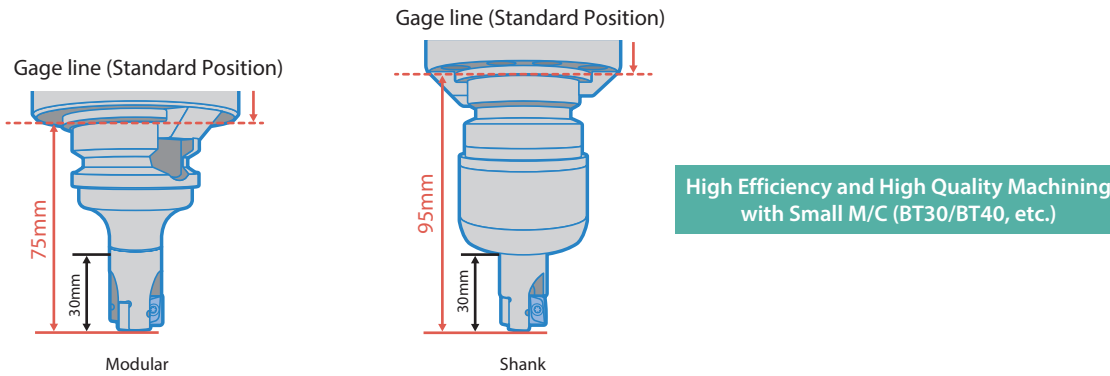

2 Applicable to a Wide Range of Applications

For a wide range of applications even in BT30 M/C

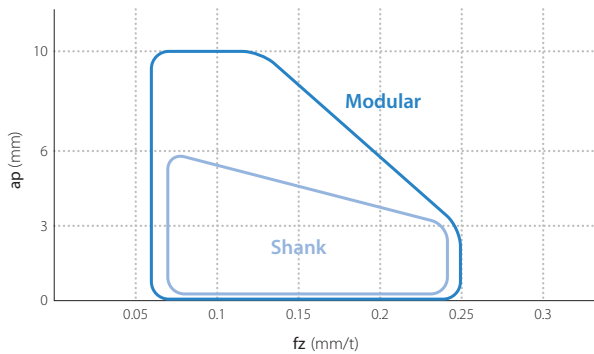

Cutting Conditions : $V_c = 150$ m/min, $a_e = 10$ mm, Shouldering, Dry
Workpiece : S55C BT30 M/C

Modular
Head : MEW20-M10-10-3T, Arbor : BT30K-M10-45
Insert : LOMU100408ER-GM(PR1525)

Shank
Holder : MEW20-S20-10-3T, Arbor : BT30 Milling Chuck(Two-face clamping)
Insert : LOMU100408ER-GM(PR1525)

3 Smooth Surface Finish

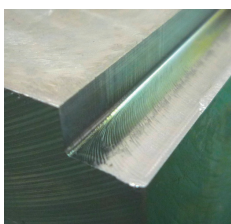

Modular



Chattering

Shank

Cutting Conditions : $V_c = 150$ m/min, $f_z = 0.15$ mm/t, $a_e = 10$ mm, Shouldering, Dry
Workpiece : S55C BT30 M/C

Modular
Head : MEW20-M10-10-3T, Arbor : BT30K-M10-45
Insert : LOMU100408ER-GM(PR1525)

Shank
Holder : MEW20-S20-10-3T, Arbor : BT30 Milling Chuck(Two-face clamping)
Insert : LOMU100408ER-GM(PR1525)

How to Mount the Inserts

1. Be sure to remove dust and chips from the insert mounting pocket.
2. Apply anti-seize compound on portion of taper and thread of clamp screw.
Attach the screw (magnetic head) to the front end of the wrench.
While lightly pressing the insert against the pocket walls, put the screw into the hole of the insert and tighten. (See Fig. 1.)
Tighten M3 screws (SB-3065TRP) slightly inclined from the insert surface. (See Fig. 2.)
3. When tightening the screw, make sure that the wrench is parallel to the screw.
For recommended torque, see Table 1
4. After tightening the screw, make sure that there is no clearance between the insert seat surface and the pocket floor of the holder or between the insert side surfaces and the pocket walls of the holder. If there is any clearance, remove the insert and mount it again according to the above steps.

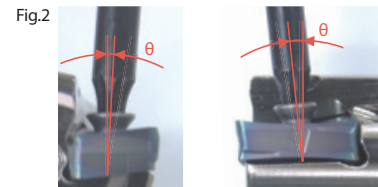
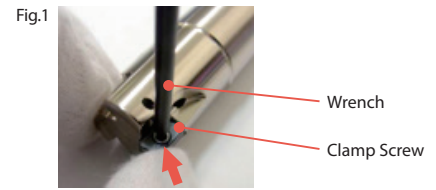

How to Attach Modular MEW Head

1. When clamping the head on the arbor, make sure there is no dust or chips inside (Fig. 1).
Do NOT put lubricant on the clamping portion.
2. Attach the head on the arbor and fix it using the wrench (Fig. 2). See Table 1 for Recommended Torque.
Note) The wrench is NOT included with product.

Table 1. Recommended Head Torque

Thread Dia. Tolerance	Wrench Width across flat (mm)	Recommended torque (N · m)
M8	12	23
M10	15	46
M12	19	80
M16	24	90

3. Confirm that the head is fixed firmly on the arbor (Fig. 3).

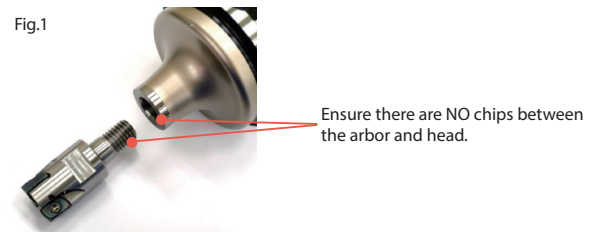

Frequently Asked Question

- Q.** Can the two-face clamping arbor be mounted on a general BT spindle?
- A.** Yes. It can be used as a general BT arbor with a general BT spindle.

It can be used as a general BT arbor, though the advantage of the two-face clamping will not apply.

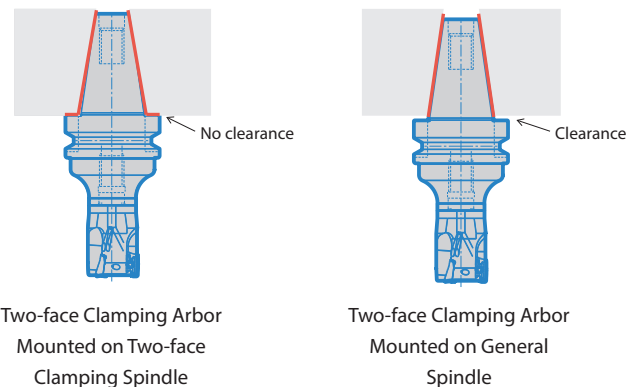

MEWH End Mill (Coolant hole for bottom insert)

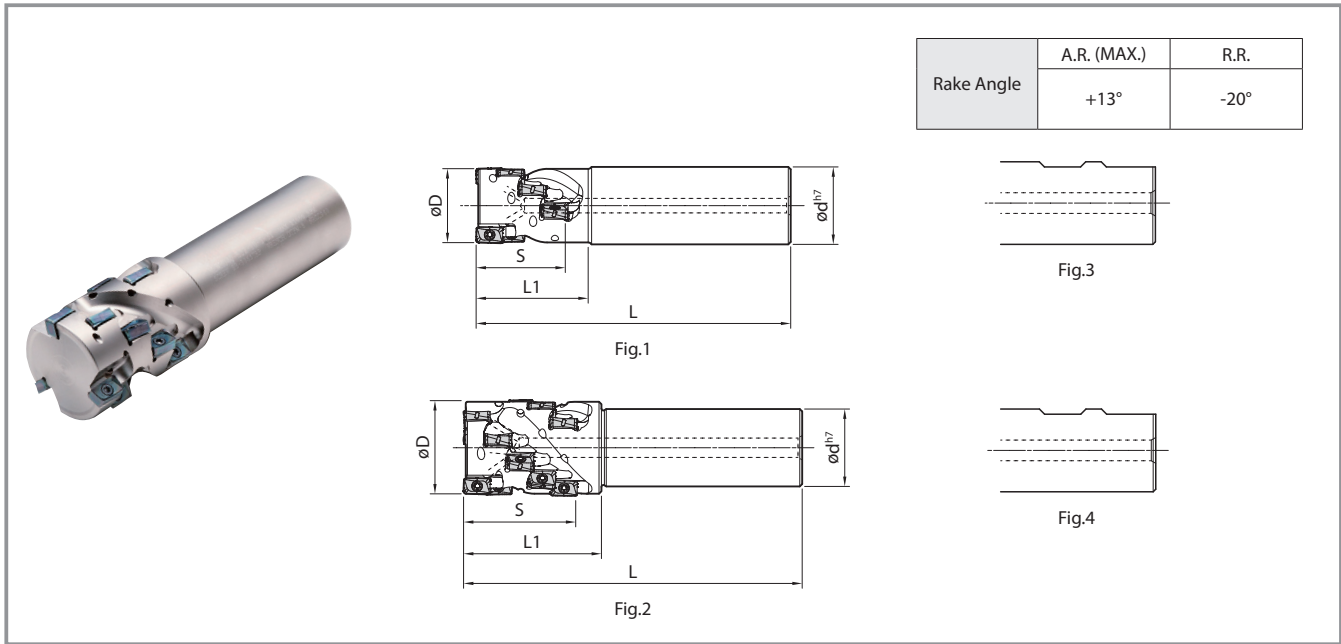

Dimension

Description	Stock	No. of Flute	No. of Stage	No. of Insert	Dimensions (mm)					Coolant Hole	Shape	Spare Parts			Applicable Inserts
					øD	ød	L	L1	S			Clamp Screw	Wrench	Anti-Seize Compound	
MEWH 025-S25-10-3-2T	●	2	3	6	25	25	120	37	28	Yes	Fig.1	SB-3065TRP	DTPM-8	P-37	LOMU1004..
032-S32-10-4-2T	●		4	8	32	32	130	46	37						
040-S32-10-5-2T	●		5	10	40		140	57	46						
040-S32-10-5-3T	●			15											
MEWH 040-S32-15-4-2T	●	2	4	8	40	32	160	63	53	Yes	Fig.2	SB-4090TRP	DTPM-15	P-37	LOMU1505..
050-S42-15-4-2T	●			12	50	42									
050-S42-15-4-3T	●				3										
MEWH 025-W25-10-3-2T	●	2	3	6	25	25	95	37	28	Yes	Fig.3	SB-3065TRP	DTPM-8	P-37	LOMU1004..
032-W32-10-4-2T	●		4	8	32	32	108	46	37						
040-W32-10-5-2T	●		5	10	40		119	57	46						
040-W32-10-5-3T	●			15											
MEWH 040-W32-15-4-2T	●	2	4	8	40	32	125	63	53	Yes	Fig.4	SB-4090TRP	DTPM-15	P-37	LOMU1505..
050-W40-15-4-2T	●			12	50	40	135								
050-W40-15-4-3T	●				3										

Coat Anti-seize Compound thinly on portion of taper and thread when insert is fixed.
 Aluminum machining is not recommended (AM Chipbreaker is not available for MEWH)

●: Standard Stock
 Recommended Cutting Conditions → P14

Applicable insert for MEWH

Insert Location Indication	Toolholder Description										
	MEWH...10...					MEWH...15...					
	Corner R(ε) (mm)					Corner R(ε) (mm)					
Bottom Edge	0.4	0.8	1.2	1.6	2.0	0.4	0.8	1.0	1.2	1.6	2.0
*Middle Edge	0.4/0.8	0.4/0.8	0.4/0.8	0.4	0.4	0.4 - 1.6	0.4 - 1.6	0.4 - 1.6	0.4 - 1.6	0.4 - 1.6	0.4 - 1.6

*For Middle Edges, It is not recommended to use the insert with larger corner R (ε) than shown in the table, because it will make finished surface uneven.

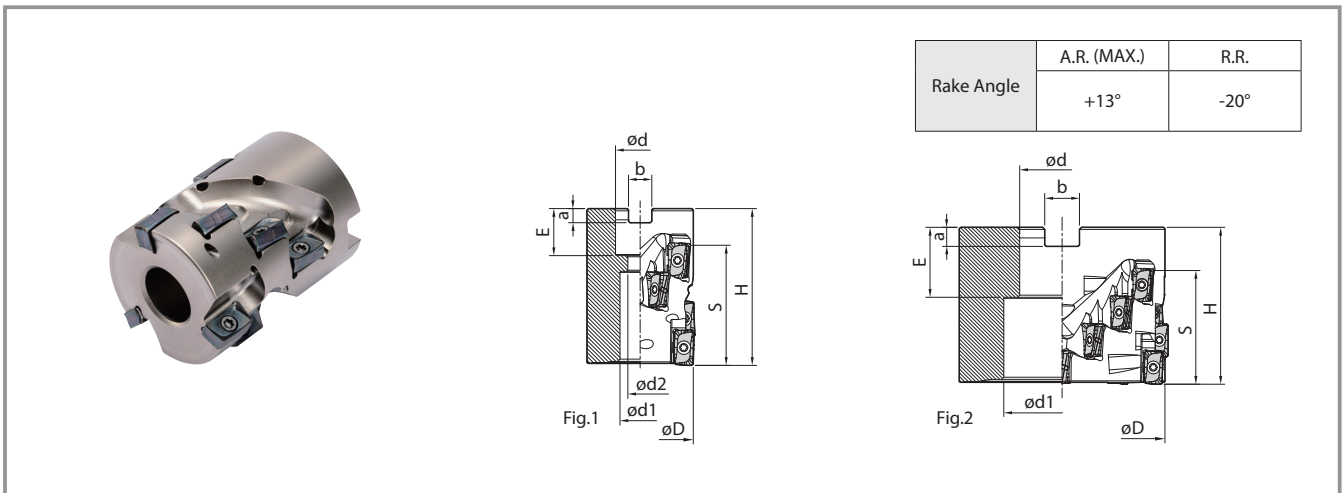

Dimension

Description	Stock	No. of Flute	No. of Stage	No. of Insert	Dimensions (mm)									Shape	Spare Parts				Applicable Inserts
					øD	ød	ød1	ød2	H	E	a	b	S		Clamp Screw	Wrench	Anti-Seize Compound	Mounting Bolt	
MEWH 040R-10-4-3T-M	●	3	4	12	40	16	15	9	53	19	5.6	8.4	37	Fig.1	SB-3065TRP	DTPM-8	P-37	HH8X25	LOMU1004-
050R-10-5-3T-M	●				5	15	50	22	18	11	64	21	6.3		10.4	46		Recommended torque for insert clamp 1.2N·m	
MEWH 050R-15-4-3T-M	●	3	4	12	50	22	18	11	70	21	6.3	10.4	53	Fig.1	SB-4090TRP	DTPM-15	P-37	HH10X30	LOMU1505-
063R-15-3-3T-M	●				3	9	63	27	20	13	58	24	7					12.4	
080R-15-4-4T-M	●	4	4	16	80	32	26	18	70	28	8	14.4	53	Recommended torque for insert clamp 3.5N·m		HH16X45			
100R-15-4-5T-M	●	5	5	20	100	40	55	—	74	33	9	16.4	53	Fig.2				—	

Coat Anti-seize Compound thinly on portion of taper and thread when insert is fixed.
Aluminum machining is not recommended (AM Chipbreaker is not available)

●: Standard Stock
Recommended Cutting Conditions → P14

Case Studies (MEW)

Construction equipment's part SS400

Vc = 250 m/min
fz = 0.14 mm/t (Vf = 1,350 mm/min)
ap × ae = 4 × 20 mm
Wet
MEW32-S32-10-4T (4 inserts)
LOMU100408ER-GM (PR1525)

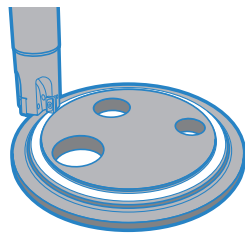

Chip Removal Rate

PR1525 **108 cc/min**

Machining Efficiency
↑ 1.5 Times

Competitor L (Positive Cutter) **72 cc/min**

MEW showed stable milling without chattering at higher feed, improving the cutting efficiency by 150%. Burrs are prevented and excellent surface finish is achieved

(User Evaluation)

Mold Part SKD61 (45HRC)

Vc = 100 m/min
fz = 0.1mm/t (Vf = 400 mm/min)
ap × ae = 3.5 × 30 mm
Dry
MEW32-S32-10-4T (4 inserts)
LOMU100408ER-GH (PR1525)

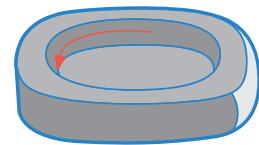

Chip Removal Rate

PR1525 **42 cc/min (Further Milling Possible)**



Machining Efficiency
↑ 2 Times

Competitor M (Positive Cutter) **21 cc/min (Unable to continue cutting)**

MEW doubled cutting efficiency. Furthermore, MEW inserts have double number of edges (4-edge), which enables a drastic cost reduction







(User Evaluation)

Applicable Inserts

Classification of Usage	P	Carbon Steel • Alloy Steel		☆	★									Applicable Toolholder	
		M	Die Steel		☆	★									
			Austenitic Stainless Steel (SUS304,etc)		★	☆				★					
Martensitic Stainless Steel (SUS403,etc)			☆					★							
K	Precipitation Hardened Stainless Steel		★												
	Gray Cast Iron							★							
N	Nodular Cast Iron							★							
	Non-ferrous Metals Almiun										★	☆			
S	Ni-base Heat-Resistant Alloy (Inconel®718,etc)		☆							★					
	Titanium Alloy (Ti-6Al-4V)		★					☆							
H	High Hardness Steel								□						
	Insert	Description	Dimension (mm)						MEGACOAT NANO			CVD Coated Carbide	DLC Coated Carbide	Carbide	
A			T	ød	W	Z	rε	PR1535	PR1525	PR1510	CA6535	PDL025	GW25		
 General Purpose	LOMU 100404ER-GM 100408ER-GM 100412ER-GM 100416ER-GM 100420ER-GM	6.6	4.0	3.4	10.9	2.1	0.4	●	●	●	●			MEW...-10.. MEWH...-10..	
						1.7	0.8	●	●	●	●				
						1.3	1.2	●	●	●	●				
						1.0	1.6	●	●	●	●				
						1.0	2.0	●	●	●	●				
	LOMU 150504ER-GM 150508ER-GM 150510ER-GM 150512ER-GM 150516ER-GM 150520ER-GM	9.2	5.6	4.8	15.7	2.2	0.4	●	●	●	●				MEW...-15.. MEWH...-15..
						1.8	0.8	●	●	●	●				
						1.6	1.0	●	●	●	●				
						1.4	1.2	●	●	●	●				
						1.0	1.6	●	●	●	●				
LOMU 100408ER-SM LOMU 150508ER-SM	6.6	4.0	3.4	10.9	1.7	0.8	●	●	●	●			MEW...-10.. MEWH...-10..		
	9.2	5.6	4.8	15.7	1.8	0.8	●	●	●	●				MEW...-15.. MEWH...-15..	
LOMU 100408ER-GH LOMU 150508ER-GH	6.6	4.0	3.4	10.9	1.7	0.8	●	●	●	●			MEW...-10.. MEWH...-10..		
	9.2	5.6	4.8	15.7	1.8	0.8	●	●	●	●				MEW...-15.. MEWH...-15..	
 Non-ferrous Metals-Aluminum (2-edge Insert)	LOGT 100408FR-AM	6.8	4.0	3.6	11.1	2.8	0.8					●	●		
	LOGT 150508FR-AM	8.9	5.6	4.9	15.9	2.8	0.8						●	●	MEW...-15..

● : Standard Stock

Appearance of LOMU...ER-GM

LOMU100404ER-GM LOMU150504ER-GM	LOMU100408ER-GM LOMU150508ER-GM
 04 Marking on Insert	 08 Has No Dimension Marking
LOMU150510ER-GM	LOMU100412ER-GM LOMU150512ER-GM
 10 Marking on Insert	 12 Marking on Insert
LOMU100416ER-GM LOMU150516ER-GM	LOMU100420ER-GM LOMU150520ER-GM
 16 Marking on Insert	 20 Marking on Insert

Applicable Chipbreaker Range (Shouldering)

LOMU10type

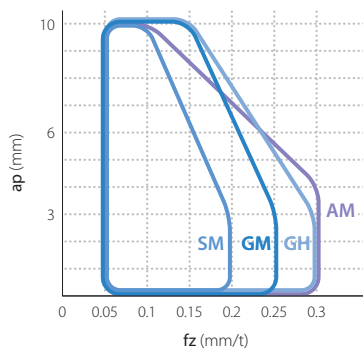

LOMU15type

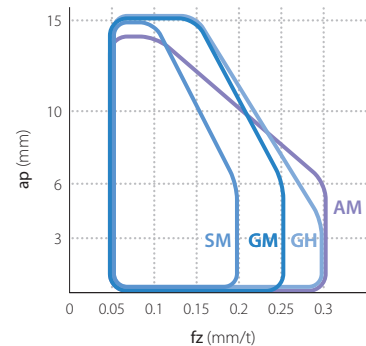

Cutting Conditions : Vc = 150 m/min, ae = øD/2 Workpiece : S50C

Recommended Cutting Conditions ★ 1st Recommendation ☆ 2nd Recommendation

Chipbreaker	Workpiece	fz:mm/t			Recommended Insert Grade (Vc: m/min)					
		Toolholder Descriptions			MEGACOAT NANO			CVD Coated Carbide	DLC Coated Carbide	Carbide
		MEW16 – MEW18	MEW20 – MEW40 MEW040R – MEW080R	MEWH025 – MEWH050 (Helical End Mill)	PR1535	PR1525	PR1510	CA6535	PDL025	GW25
G M	Carbon Steel (SXXC)	0.06 – 0.1 – 0.2	0.08 – 0.15 – 0.25	0.06 – 0.1 – 0.2	120 – 180 – 250 ☆	120 – 180 – 250 ★	—	—	—	—
	Alloy Steel (SCM,etc)	0.06 – 0.1 – 0.14	0.08 – 0.15 – 0.2	0.06 – 0.1 – 0.14	100 – 160 – 220 ☆	100 – 160 – 220 ★	—	—	—	—
	Die Steel (SKD,etc)	0.06 – 0.08 – 0.12	0.08 – 0.12 – 0.2	0.06 – 0.08 – 0.12	80 – 140 – 180 ☆	80 – 140 – 180 ★	—	—	—	—
	Austenitic Stainless Steel (SUS304,etc)	0.06 – 0.08 – 0.12	0.08 – 0.12 – 0.15	0.06 – 0.08 – 0.12	100 – 160 – 200 ☆	100 – 160 – 200 ☆	—	—	—	—
	Martensitic Stainless Steel (SUS403,etc)	0.06 – 0.08 – 0.12	0.08 – 0.12 – 0.2	0.06 – 0.08 – 0.1	150 – 200 – 250 ☆	—	—	180 – 240 – 300 ★	—	—
	Precipitation Hardened Stainless Steel (SUS630,etc)	0.06 – 0.08 – 0.12	0.08 – 0.12 – 0.2	0.06 – 0.08 – 0.1	90 – 120 – 150 ★	—	—	—	—	—
	Gray Cast Iron (FC)	0.06 – 0.1 – 0.17	0.08 – 0.18 – 0.25	0.06 – 0.1 – 0.17	—	—	120 – 180 – 250 ★	—	—	—
	Nodular Cast Iron (FCD)	0.06 – 0.08 – 0.12	0.08 – 0.15 – 0.2	0.06 – 0.08 – 0.12	—	—	100 – 150 – 200 ★	—	—	—
	Ni-base Heat-Resistant Alloy (Inconel®718,etc)	0.06 – 0.08 – 0.12	0.08 – 0.12 – 0.15	0.06 – 0.08 – 0.1	20 – 30 – 50 ☆	—	—	20 – 30 – 50 ★	—	—
	Titanium Alloy (Ti-6Al-4V)	0.06 – 0.08 – 0.12	0.08 – 0.15 – 0.2	0.06 – 0.08 – 0.12	40 – 60 – 80 ☆	—	30 – 50 – 70 ☆	—	—	—
S M	Carbon Steel (SXXC)	0.06 – 0.1 – 0.17	0.08 – 0.15 – 0.2	0.06 – 0.1 – 0.17	120 – 180 – 250 ☆	120 – 180 – 250 ★	—	—	—	—
	Alloy Steel (SCM,etc)	0.06 – 0.08 – 0.12	0.08 – 0.12 – 0.18	0.06 – 0.08 – 0.12	100 – 160 – 220 ☆	100 – 160 – 220 ★	—	—	—	—
	Die Steel (SKD,etc)	0.06 – 0.08 – 0.12	0.08 – 0.1 – 0.15	0.06 – 0.08 – 0.12	80 – 140 – 180 ☆	80 – 140 – 180 ★	—	—	—	—
	Austenitic Stainless Steel (SUS304,etc)	0.06 – 0.08 – 0.12	0.08 – 0.1 – 0.15	0.06 – 0.08 – 0.12	100 – 160 – 200 ★	100 – 160 – 200 ☆	—	—	—	—
	Martensitic Stainless Steel (SUS403,etc)	0.06 – 0.08 – 0.12	0.08 – 0.1 – 0.15	0.06 – 0.08 – 0.1	150 – 200 – 250 ☆	—	—	180 – 240 – 300 ★	—	—
	Precipitation Hardened Stainless Steel (SUS630,etc)	0.06 – 0.08 – 0.12	0.08 – 0.1 – 0.15	0.06 – 0.08 – 0.1	90 – 120 – 150 ☆	—	—	—	—	—
	Ni-base Heat-Resistant Alloy (Inconel®718,etc)	0.06 – 0.08 – 0.1	0.08 – 0.1 – 0.12	0.06 – 0.08 – 0.1	20 – 30 – 50 ☆	—	—	20 – 30 – 50 ★	—	—
	Titanium Alloy (Ti-6Al-4V)	0.06 – 0.08 – 0.12	0.08 – 0.12 – 0.15	0.06 – 0.08 – 0.12	40 – 60 – 80 ★	—	30 – 50 – 70 ☆	—	—	—
G H	Carbon Steel (SXXC)	0.06 – 0.1 – 0.2	0.08 – 0.2 – 0.3	0.06 – 0.1 – 0.2	120 – 180 – 250 ☆	120 – 180 – 250 ★	—	—	—	—
	Alloy Steel (SCM,etc)	0.06 – 0.1 – 0.14	0.08 – 0.2 – 0.25	0.06 – 0.1 – 0.14	100 – 160 – 220 ☆	100 – 160 – 220 ★	—	—	—	—
	Die Steel (SKD,etc)	0.06 – 0.08 – 0.12	0.08 – 0.15 – 0.22	0.06 – 0.08 – 0.12	80 – 140 – 180 ☆	80 – 140 – 180 ★	—	—	—	—
	Austenitic Stainless Steel (SUS304,etc)	0.06 – 0.08 – 0.12	0.08 – 0.12 – 0.15	0.06 – 0.08 – 0.12	100 – 160 – 200 ☆	100 – 160 – 200 ☆	—	—	—	—
	Martensitic Stainless Steel (SUS403,etc)	0.06 – 0.08 – 0.12	0.08 – 0.12 – 0.2	0.06 – 0.08 – 0.1	150 – 200 – 250 ☆	—	—	180 – 240 – 300 ☆	—	—
	Precipitation Hardened Stainless Steel (SUS630,etc)	0.06 – 0.08 – 0.12	0.08 – 0.12 – 0.2	0.06 – 0.08 – 0.1	90 – 120 – 150 ☆	—	—	—	—	—
	Gray Cast Iron (FC)	0.06 – 0.1 – 0.2	0.08 – 0.22 – 0.3	0.06 – 0.1 – 0.2	—	—	120 – 180 – 250 ☆	—	—	—
	Nodular Cast Iron (FCD)	0.06 – 0.08 – 0.15	0.08 – 0.18 – 0.25	0.06 – 0.08 – 0.15	—	—	100 – 150 – 200 ☆	—	—	—
	Ni-base Heat-Resistant Alloy (Inconel®718,etc)	0.06 – 0.08 – 0.12	0.08 – 0.12 – 0.15	0.06 – 0.08 – 0.1	20 – 30 – 50 ☆	—	—	20 – 30 – 50 ☆	—	—
	Titanium Alloy (Ti-6Al-4V)	0.06 – 0.08 – 0.12	0.08 – 0.15 – 0.2	0.06 – 0.08 – 0.12	40 – 60 – 80 ☆	—	30 – 50 – 70 ☆	—	—	—
A M	Aluminum (Si less 13%)	0.05 – 0.12 – 0.2	0.05 – 0.18 – 0.3	NOT Recommend	—	—	—	—	★ 200 – 900	☆ 200 – 300
	Aluminum (Si over 13%)	0.05 – 0.08 – 0.12	0.05 – 0.12 – 0.2		—	—	—	—	—	—

Bold numbers in the graph indicates the most recommended value of feed (f). Adjust cutting speed and feed rate according to the actual machining conditions.
Coolant is recommended for Ni-base heat resistant alloy and titanium alloy with MEW.
Coolant is recommended for stainless steel, Ni-base heat resistant alloy and titanium alloy with MEWH.

Vertical milling

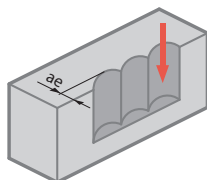

Available for vertical milling

Insert Description	Maximum Width of Cut (ae)
LOMU10 LOGT10	5 mm
LOMU15 LOGT15	7 mm

NOT available for ramping and helical milling, because interference between workpiece and insert may occur.

MEW Cutting Performance

LOMU1004type

Description	Shouldering ($ae=\phi D/2$)	Slotting
MEW16...-10 MEW18...-10		
MEW20...-10 MEW50...-10		
MEW20-S20 -10-150-2T MEW25-S25 -10-170-2T (Long Shank)		
MEW032R...-10 MEW063R...-10		

LOMU1505type

Description	Shouldering ($ae=\phi D/2$)	Slotting
MEW25...-15 MEW50...-15		
MEW040R...-15 MEW080...-15		

Cutting Conditions : $V_c = 180$ m/min, GM Chipbreaker Workpiece : S50C
 Overhang Length
 1. End Mill : Overhang length is "L" of the dimension list
 2. Face Mill : Overhang length is "H" of the dimension list + minimum arbor overhang

MEWH Cutting Performance

LOMU1004type

Cutting Dia.	Description	2 Flute ($ap \times ae$)	Description	3 Flute ($ap \times ae$)
ø25	MEWH025 -S25-10-3-2T		—	—
ø32	MEWH032 -S32-10-4-2T		—	—
ø40	MEWH040 -S32-10-5-2T		MEWH040 -S32-10-5-3T	

LOMU1505type

Cutting Dia.	Description	2 Flute ($ap \times ae$)	Description	3 Flute ($ap \times ae$)
ø40	MEWH040 -S32-15-4-2T		—	—
ø50	MEWH050 -S42-15-4-2T		MEWH050 -S42-15-4-3T	

Cutting Conditions : $V_c = 120$ m/min, $f_z = 0.08 - 0.12$ mm/t, GM Chipbreaker Workpiece : SCM435
 Overhang Length
 End Mill : Overhang length is "L1" of the dimension list